

AMY-5M

u-blox 5 ROM-Based GPS Module

Data Sheet

Abstract

Technical data sheet describing the high performance u-blox 5 based AMY-5M GPS receiver module.

The AMY-5M module features the industry's smallest form factor and is a fully tested standalone solution that requires no host integration.

This module combines exceptional GPS performance with highly flexible power, design, and serial communication options.



8 x 6.5 x 1.2 mm

Document Information

Title	AMY-5M
Subtitle	u-blox5 ROM-Based GPS Module
Document type	Data Sheet
Document number	GPS.G5-MS5-08196-A3
Document status	Preliminary This document contains preliminary data, revised and supplementary data may be published later.

This document applies to the following products:

Name	Type number	ROM/FLASH version	PCN reference
AMY-5M	AMY-5M-0003	ROM5.00	

This document and the use of any information contained therein, is subject to the acceptance of the u-blox terms and conditions. They can be downloaded from www.u-blox.com.

u-blox makes no warranties based on the accuracy or completeness of the contents of this document and reserves the right to make changes to specifications and product descriptions at any time without notice.

u-blox reserves all rights to this document and the information contained herein. Reproduction, use or disclosure to third parties without express permission is strictly prohibited. Copyright © 2011, u-blox AG.

u-blox® is a registered trademark of u-blox Holding AG in the EU and other countries. ARM® is the registered trademark of ARM Limited in the EU and other countries.



Contents

Contents.....	3
1 Functional description.....	5
1.1 Overview	5
1.2 Product features	5
1.3 GPS performance.....	6
1.4 Block diagram.....	7
1.5 Assisted GPS (A-GPS).....	7
1.6 RTC	7
1.7 SuperSense Indoor GPS	7
1.8 Protocols and interfaces.....	7
1.8.1 UART.....	8
1.8.2 USB.....	9
1.8.3 Display Data Channel (DDC).....	9
1.9 External Serial E ² PROM	9
1.10 Antenna.....	9
1.11 Power management.....	9
1.11.1 Operating modes	10
1.11.2 Eco mode	10
1.11.3 Dual Power Supply	10
1.12 Configuration	11
1.12.1 Configuration Pins.....	11
2 Mechanical specifications	12
2.1 Pin assignment	13
3 Electrical specifications	14
3.1 Absolute maximum ratings.....	14
3.2 Operating Conditions	15
3.2.1 DC Electrical Characteristic.....	15
3.2.2 BB AC Parameters	16
3.2.3 RF AC Parameters.....	16
3.2.4 Power Consumption.....	16
4 Design-in.....	17

5 Reliability tests and approvals	17
5.1 Approvals	17
6 Product handling	18
6.1 Packaging.....	18
6.1.1 Reels	18
6.1.2 Tapes	19
6.2 Shipment, storage and handling	20
6.2.1 Moisture Sensitivity Levels	20
6.2.2 Shipment.....	20
6.2.3 Storage and floor life.....	22
6.2.4 Drying	22
6.2.5 Reflow soldering	22
6.2.6 ESD handling precautions.....	23
7 Default settings.....	24
8 Labeling and ordering information.....	25
8.1 Product labeling.....	25
8.2 Explanation of codes.....	25
8.3 Ordering information.....	26
Related documents.....	26
Revision history	26
Contact.....	27

1 Functional description

1.1 Overview

The AMY-5M is the GPS industry's smallest standalone receiver. It is a fully tested ROM-based solution that features the high performance u-blox 5 positioning engine. The AMY-5M has been developed for easy design and integration for high volumes and requires no host integration, which enables extremely short times to market.

The AMY-5M offers three different serial interfaces. The receiver supports a standard Crystal, which provides very fast acquisition and tracking performance at an economical price. Furthermore, 2-layer PCB integration is supported, which brings additional cost savings.

AMY-5M's miniature size means that it can be integrated into the smallest portable devices. Advanced jamming suppression mechanisms and innovative RF architecture ensure maximum performance even in hostile signal environments.

1.2 Product features

Series	Power	Size	Memory	Function	Antenna	Input / Output
	Voltage range [V]	Thickness [mm]	Programmable (Flash) FW update	Power Save mode KickStart Dead Reckoning SuperSense® Precision Timing	Antenna supply Antenna supervisor	UART USB SPI DDC (I ² C compliant) Reset input Configuration pins
AMY-5M	1.75 – 2.0 2.50 – 3.6	1.2		•	E •	1 1 1 • 2

E = With external circuitry

Table 1: Features of the AMY-5M

1.3 GPS performance

Parameter	Specification	
Receiver type	Channels	50
	Frequency	L1
	Signals	GPS C/A Code
Configuration	Time pulse	$f = 0.25 \dots 999 \text{ Hz}$ ($T_p = 1/f - 1\text{ms}$)
	Navigation update rate	up to 4Hz
Time-To-First-Fix ¹	Cold Start (Autonomous)	36s
	Warm Start (Autonomous)	36s
	Hot Start (Autonomous)	<1s
	Aided Starts ²	4s
Sensitivity ³	Tracking & Navigation	-159 dBm
	Reacquisition	-159 dBm
	Cold Start (Autonomous)	-141 dBm
Accuracy	Horizontal position ⁴	< 2.5 m Autonomous < 2.0 m SBAS
	Timepulse signal	30 ns RMS <60 ns 99%
	Velocity ⁵	0.1m/s
	Heading ⁵	0.5 degrees
	Limits ⁶	Acceleration
	Altitude	50000 m
	Velocity	500 m/s

Table 2: AMY-5M GPS performance

¹ All satellites at -130 dBm

² Dependent on aiding data connection speed and latency

³ Demonstrated with a good active antenna

⁴ CEP, 50%, 24 hours static, -130dBm, SEP: <3.5m

⁵ 50% @ 30 m/s

⁶ Assuming Airborne <4g platform

1.4 Block diagram

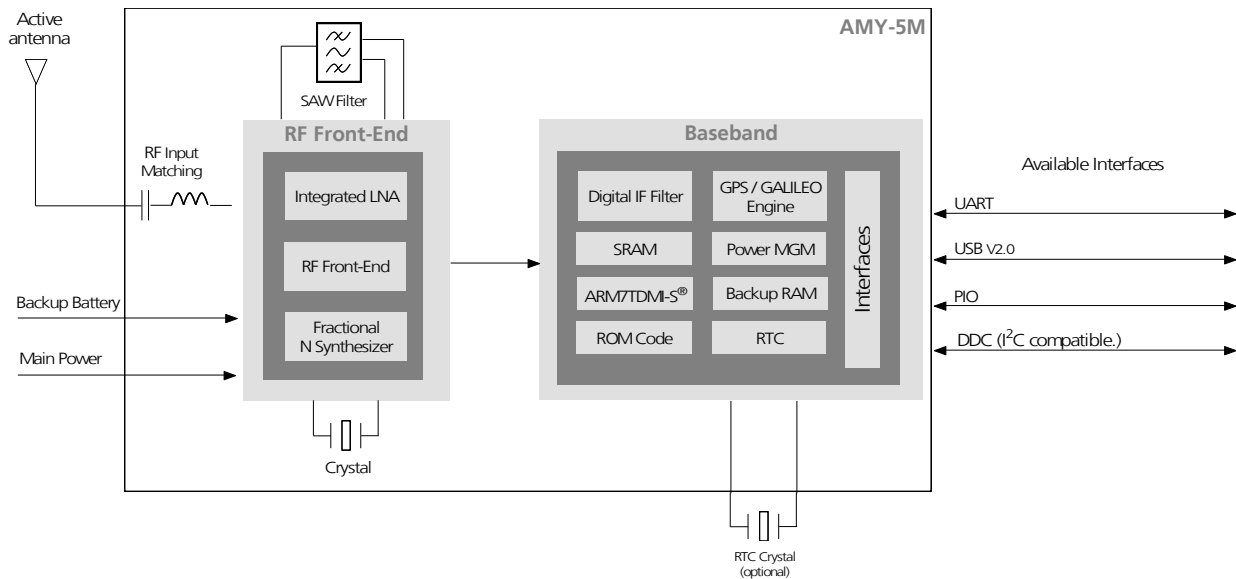

Figure 1: AMY-5M Hardware Block Schematic Assisted GPS (A-GPS)

1.5 Assisted GPS (A-GPS)

Supply of aiding information like ephemeris, almanac, rough last position and time and satellite status and an optional time synchronization signal will reduce time to first fix significantly and improve the acquisition sensitivity. The AMY-5M module supports the u-blox AssistNow Online and AssistNow Offline-GPS services, and is OMA SUPL ready.

1.6 RTC

The RTC crystal is optional as it is only required in stand-alone applications where hot or warm starts are enabled. In these cases, actual time is maintained in the RTC and Ephemeris and other last known data is kept in the backup RAM. In A-GPS based systems, the RTC is not required and coarse or fine time information is available from the network or from the host application.

The RTC Crystal is not required if the Host CPU provides the time via a serial interface (UBX-AID-INI message) or a digital 32.768 kHz signal is available.

1.7 SuperSense Indoor GPS

AMY-5M comes with SuperSense, providing ultra-fast acquisition/reacquisition and exceptional tracking sensitivity. SuperSense enables best-in-class tracking and navigation in difficult signal environments such as urban canyons or indoor locations.

1.8 Protocols and interfaces

Protocol	Type
NMEA	Input/output, ASCII, 0183, 2.3 (compatible to 3.0)
UBX	Input/output, binary, u-blox proprietary

Table 3: Available protocols

Both protocols are available on UART, USB and DDC. For specification of the various protocols see the u-blox 5 Receiver Description including Protocol Specification [2].

AMY-5M supports a number of peripheral interfaces for serial communication. The embedded firmware uses these interfaces according to their respective protocol specifications. For specific applications, the firmware also supports the connection of peripheral devices, such as external memories or sensors, to some of the interfaces.

1.8.1 UART

The AMY-5M includes a UART interface. The configuration can be defined at system start-up through configuration pins or settings stored permanently in non-volatile memory.

1.8.2 USB

AMY-5M provides a USB version 2.0 FS (Full Speed, 12Mbit/s) interface as an alternative to the UART. The pull-up resistor on USB_DP is integrated to signal a full-speed device to the host. The VDD_USB pin supplies the USB interface, independently from the VDD_IO pin.

u-blox provides a Microsoft® certified USB driver for Windows XP, Windows Vista and Windows 7 operating systems.

Operating System	Support level
Windows XP	Certified
Windows Vista	Certified
Windows 7	Certified

Table 4: Operating systems supported by USB driver

1.8.3 Display Data Channel (DDC)

The I²C compatible DDC interface can be used either to access external devices with a serial interface (e.g. EEPROM or A/D converters) or to interface with a host CPU. It is capable of master and slave operation and communicates at a rate of <100kbit/s.

 Master Mode is only supported when external EEPROM is used to store configuration. No other nodes are connected to the bus.

 The DDC interface supports 7-bit addressing and Max speed 100kb/sec.

1.9 External Serial E²PROM

Using the DDC an optional external serial E²PROM can be connected to store power-up configuration settings.

 For additional information consult the AMY-5M Hardware Integration Manual [1].

1.10 Antenna

The AMY-5M module is designed for use with passive and active⁷ antennas.

 With AMY-5M an external LNA is required if no active antenna is used.

Parameter	Specification
Minimum gain	15 - 20 dB (to compensate signal loss in RF cable)
Maximum noise figure	1.5 dB
Maximum gain	50 dB

Table 5: Active Antenna Requirements

1.11 Power management

 For more information about power management strategies, see the u-blox 5 Receiver Description including Protocol Specification [2].

⁷ For information on using active antennas with AMY-5 modules, see the AMY-5 Hardware Integration Manual [1].

1.11.1 Operating modes

AMY-5M modules only operate in Eco mode, this mode optimizes the use of the acquisition engine to deliver lower current consumption.

1.11.2 Eco mode

In Eco mode, u-blox 5 receivers use the acquisition engine to search for new satellites only when needed for navigation:

- In cold starts, u-blox 5 searches for enough satellites to navigate and optimizes use of the acquisition engine to download their ephemeris.
- In non-cold starts, u-blox 5 focuses on searching for visible satellites whose orbits are known from the Almanac.

In Eco mode, the u-blox 5 acquisition engine limits use of its searching resources to minimize power consumption. As a consequence the time to find some satellites at weakest signal level might be slightly increased.

u-blox 5 deactivates the acquisition engine as soon as a position is fixed and a sufficient number (at least 4) of satellites are being tracked. The tracking engine continues to search and track new satellites without orbit information.

1.11.3 Dual Power Supply

The AMY-5M provides the following power supply options:

1. A single supply voltage can be used for the complete system.
2. The RF and baseband sections can be separately supplied using different voltages.

Using dual voltages enables significant reductions in power consumption. The highest efficiencies are achieved by supplying the baseband with 1.4V and the RF with 1.8V.

1.12 Configuration

System configuration goes through multiple steps. The priority of the information found at different sources is as follows:

3. Actual configuration in system RAM
4. Configuration in backup RAM
5. Configuration in serial EEPROM
6. Configuration through CFG pins
7. Default (ROM) settings

During system boot, the system first starts from the ROM default settings. Then it tries to find out where the actual configuration can be found, i.e. it searches for EEPROM, backup RAM and looks for valid contents. Thus, a search tree can be built and any configuration setting that is needed by the firmware is searched downwards from the most actual (system RAM) to the most outdated (system ROM) information. The system uses the first valid information it finds.

1.12.1 Configuration Pins

The AMY-5M provides 2 configuration pins (**CFG_xxx**) for boot-time configuration. These become effective immediately after start-up. Once the module has started, the configuration settings may be modified with UBX configuration messages. The modified settings remain effective until power-down or reset. If these settings have been stored in battery-backup RAM, then the modified configuration will be retained, as long as the backup battery supply is not interrupted. In the following tables, all default settings (pin left open) are **bold**.

The first step performed by the system at boot-time is to analyze the SAFEBOOT_N pin. If it is pulled low, the system will start up in safe mode using as few configuration settings as possible and with only the minimum functionality required to establish communication with the host. No GPS operation is started.

TDI / SAFEBOOT_N

1	Normal Boot
0	Safe Mode, minimal ROM boot, Ignore Backup RAM & FLASH.

Table 6: SAFEBOOT Configuration

The protocol and baud rate of the communication interfaces (UART, USB, DDC) can be configured using the CFG_COM pins as follows:

PIO20 / CFG_COM1	PIO19 / CFG_COM0	Protocol	Messages	UARTBaud rate	USB power
1	1	NMEA	GSV, RMC, GSA, GGA, GLL, VTG, TXT	9600	BUS Powered
1	0	NMEA	GSV, RMC, GSA, GGA, GLL, VTG, TXT	38400	Self Powered
0	1	NMEA	GSV ⁸ RMC, GSA, GGA, VTG, TXT	4800	BUS Powered
0	0	UBX	NAV-SOL, NAV-STATUS, NAV-SVININFO, NAV-CLOCK, INF, MON-EXCEPT	57600	BUS Powered

Table 7: COM Configuration

⁸ Every 5th fix.

2 Mechanical specifications

Dimensions			
Parameter	Description	Specification	
A	Width	8.00 ±0.05mm	[314 ±1.9mil]
B	Height	6.50 ±0.05mm	[256 ±1.9mil]
C	Thickness	1.20 ±0.05mm	[47 ±1.9mil]
D	Pad Pitch X-Direction	0.80 ±0.05mm	[31.5 ±1.9mil]
E	Edge to Pad Pitch	0.80 ±0.05mm	[31.5 ±1.9mil]
F	Edge to Pad Pitch	0.85 ±0.05mm	[33 ±1.9mil]
G	Pad Pitch Y-Direction	0.80 ±0.05mm	[31 ±1.9mil]
H	Pin Dimensions (50x)	0.40 x 0.40 ±0.05mm	[16 x 16 ±1.9mil]
Weight		0.15 g	

Table 8: Pin Diagram

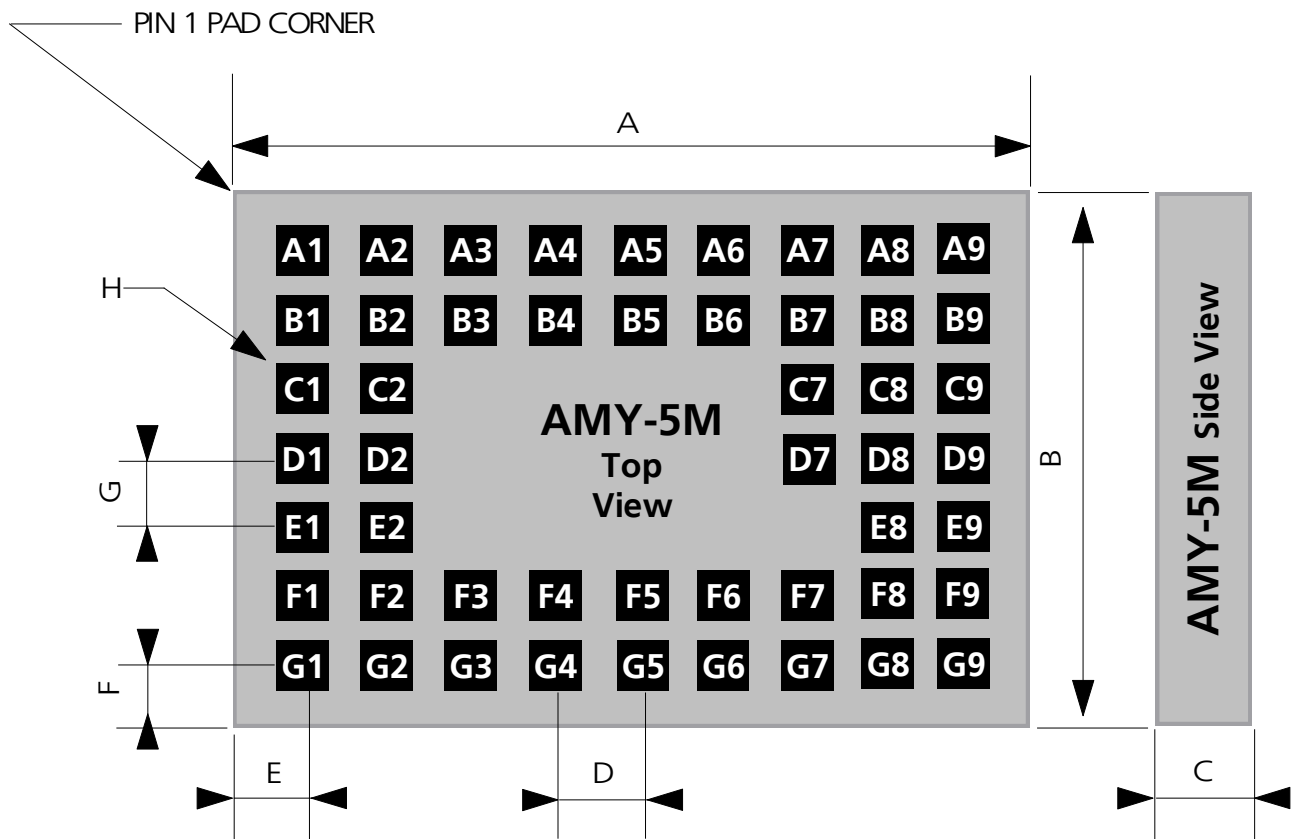

Figure 2: Dimensions



For information regarding the Paste Mask and Footprint see the AMY-5M Hardware Integration Manual [1].

2.1 Pin assignment

No	Name	I/O	Description
A1	RF_IN	I	RF Input
A2	GND	I	Ground
A3	NC		
A4	GND	I	Ground
A5	XTAL_OUT	O	RTC Output
A6	XTAL_IN	I	RTC Input
A7	VDD_LNA	O	LNA Power Supply
A8	VDD_ANA	O	Analog Power
A9	VDD_RF	I	Core Power
B1	GND	I	Ground
B2	GND	I	Ground
B3	Reserved	I/O	Reserved
B4	GND	I	Ground
B5	GND	I	Ground
B6	GND	I	Ground
B7	V_TH	I	Reset Threshold
B8	GND	I	Ground
B9	VDD_USB	I	USB Power
C1	PIO8 / EXTINT1	I	External Interrupt / Alternative function
C2	Reserved	I/O	Reserved
C7	USB_DM	I/O	USB
C8	PIO18	I/O	Alternative function
C9	PIO21	I/O	Reserved
D1	PIO7 / EXTINT0	I	External Interrupt / Time Mark
D2	Reserved	I/O	Reserved
D7	USB_DP	I/O	USB
D8	V_RESET	I	Supply Monitor
D9	VDD_3V	I	Main RF Supply
E1	Reserved	I	Reserved
E2	Reserved	I	Reserved
E8	PIO23	I/O	Reserved
E9	VDD_B	O	Backup Power
F1	TIMEPULSE	O	
F2	GND	I	Ground
F3	PIO17	I/O	Alternative function
F4	PIO19 / CFG_COM0	I/O	Configuration
F5	PIO20 / CFG_COM1	I/O	Configuration
F6	PIO6	I/O	Reserved
F7	Reserved	I/O	Reserved
F8	GND	I	Ground
F9	V_DCDC	I	Main Core Supply
G1	VDD_IO	I	I/O Ring Supply
G2	TDI / SAFEBOOT_N	I	Boot Mode Selection
G3	PIO3 / SCL2	I/O	DDC for peripherals
G4	PIO2 / SDA2	I/O	DDC for peripherals
G5	PIO5 / TxD1	I/O	Asynchronous Serial
G6	PIO4 / RxD1	I	Asynchronous Serial
G7	V_BCKP	I	Backup voltage supply
G8	VDD_C	O	Core Power
G9	NC	O	Not Connected

Table 9: Pinout

3 Electrical specifications



Limiting values given are in accordance with the Absolute Maximum Rating System (IEC 134). Stress above one or more of the limiting values may cause permanent damage to the device. These are stress ratings only and operation of the device at these or at any other conditions above those given in the Characteristics sections of the specification is not implied. Exposure to limiting values for extended periods may affect device reliability.



Where application information is given, it is advisory only and does not form part of the specification.

3.1 Absolute maximum ratings

Parameter	Symbol	Condition	Min	Max	Units
DC Current through any pin (except supplies)	I _{pin}			10	mA
Input Voltage on any pin with respect to ground	V _i		-0.5	VDD ⁹ +0.5	V
Input Voltage on digital input pin with respect to ground	V _{i3_6}		-0.5	3.6	V
Input Voltage on 4.8V tolerant pins with respect to ground	V _{i4_8}		-0.5	4.8	V
Junction Temperature	T _{jun}		-40	+105	°C
Storage Temperature	T _s		-40	+125	°C
Supply Voltage digital cores	VDD_C VDD_B		-0.5	1.6	V
Supply Voltage I/O ring	VDD_IO		-0.5	3.8	V
Supply Voltage USB	VDD_USB		-0.5	3.8	V
Supply Voltage RF Front-end	VDD_RF		-0.5	3.6	V
Baseband main core LDO input	V_DCDC		-0.5	3.6	V
Baseband backup core LDO inputs Reset Monitor	V_BCKP V_RESET		-0.5	3.6	V
RF LDO input	VDD_3V		-0.5	3.6	V
RF Input Power	Pr _{fin}			-5	dBm
Total Power Dissipation	P _{tot}			500	mW
Maximum ESD Stress Level Applied; according to human body model (100pF; 1.5kΩ).	V _{ESD(HBM)}	RF pins All other pins		1500 2000	V
Maximum ESD Stress Level Applied; according to machine model; (200pF; 0.75mH).	V _{ESD(MM)}	RF pins All other pins		150 200	V

Table 10: Absolute maximum ratings



GPS receivers are Electrostatic Sensitive Devices (ESD) and require special precautions when handling. For more information see the *AMY-5M Hardware Integration Manual* [1].



Stressing the device beyond the “Absolute Maximum Ratings” may cause permanent damage. These are stress ratings only. The product is not protected against overvoltage or reversed voltages. If necessary, voltage spikes exceeding the power supply voltage specification, given in table above, must be limited to values within the specified boundaries by using appropriate protection diodes.

⁹ VDD is the voltage of the power domain connected to the pin.

3.2 Operating Conditions

The test conditions specified in Table 11 apply to all characteristics defined in this section.

Symbol	Parameter	Min.	Typ.	Max.	Unit
Tamb	Ambient Temperature	-40	+25	+85	°C
GND	Ground		0		V
VDD_C VDD_B	Supply Voltage digital core (internally generated)		1.2		V
VDD_IO	Supply Voltage I/O ring		3.3		V
VDD_USB	Supply Voltage USB		3.3		V
VDD_3V	Supply Voltage RF		3.3		V
VDD_RF	Supply Voltage RF (internally generated)		1.8		V
Fref	Internal Reference Frequency		26		MHz

Table 11: Test Conditions

3.2.1 DC Electrical Characteristic

Symbol	Parameter	Min.	Typ.	Max.	Unit
VDD_C VDD_B	Supply Voltage digital cores	1.1	1.2	1.3	V
VDD_ANA	Analog Power		1.7		V
VDD_LNA	LNA Power Supply		1.7		V
VDD_RF	Supply Voltage RF Front-end (internal generation optional)	1.75	1.8	2.0	V

Table 12: Internally Generated LDO Voltages

Symbol	Parameter	Condition	Min.	Typ.	Max.	Unit
V_BCKP	Input voltage for VDD_B LDO	Backup mode	1.4		3.6	V
V_DCDC	Input voltage for VDD_C LDO		1.4		3.6	V
VDD_3V	Input voltage for VDD_RF LDO		2.5	3.3	3.6	V
POR_MR_u	Rising Threshold value for V_Reset	V_TH open V_TH = 0V		1.65 2.45		V
POR_MR_l	Falling Threshold value V_Reset	V_TH open V_TH = 0V		1.60 2.35		V
VDD_IO	Supply Voltage I/O ring		1.65	3.3	3.6	V
VDD_USB	Supply Voltage USB		3.0	3.3	3.6	V

Table 13: Externally Supplied Voltages

Symbol	Parameter	Condition	Min.	Typ.	Max.	Unit
Ileak	Leakage current input pins			< 1		nA
Vil	Low level input voltage				0.2*VDD_IO	V
Vih	High level input voltage		0.7* VDD_IO		VDD_IO+0.5	V
Vil_B	Low level input voltage				0.2*VDD_B	V
Vih_B	High level input voltage		0.7*VDD_B		4.8	V
Vol	Low level output voltage	Iol=4mA			0.4	V
Voh	High level output voltage	Ioh=4mA	VDD_IO- 0.4V			V
Rpu	Pull-up resistor			113		kΩ
Rpd	Pull-down resistor			83		kΩ

Table 14: Digital IO Pins

Symbol	Parameter	Condition	Min.	Typ.	Max.	Unit
Ileak	Leakage current input pins				1	uA
Vil	Low level input voltage	VDD_USB >= 3.0 V	0		0.8	V
Vih	High level input voltage	VDD_USB >= 3.0 V	2.0		VDD_USB	V
Vol	Low level output voltage	R _L = 1.425 kΩ to VDD_USB, VDD_USB >= 3.0 V, 27 Ω external series resistor			0.3	V
Voh	High level output voltage	R _L = 14.25 kΩ to GND, VDD_USB >= 3.0, 27 Ω external series resistor	2.8			V
Rpui	Pull-up resistor, Idle State		900		1575	Ω
Rpuo	Pull-up resistor, Operational State		1425		3090	Ω

Table 15: USB Pins

3.2.2 BB AC Parameters

Symbol	Parameter	Condition	Min.	Typ.	Max.	Unit
RTC_Fxtal	RTC Crystal Resonant Frequency			32768		Hz
RTC_T_start	RTC Startup time			1		sec
RTC_losc	32KHz OSC current source			1		uA
RTC_Drive	32KHz OSC Drive level	ESR = 50 kΩ		50		nW
RTC_Amp	32KHz OSC oscillation amplitude	ESR = 50 kΩ		141		mVpp
RTC_ESR	32KHz Xtal Equivalent Series Resistance			50		kΩ
RTC_CL	RTC Load capacitance on Crystal	ESR = 50 kΩ	-20%	10.7	+20%	pF

Table 16: Baseband AC parameters

3.2.3 RF AC Parameters

Symbol	Parameter	Conditions	Min	Typ	Max	Unit
Fin	Receiver Input Frequency			1575.42		MHz
NFtot	Receiver Chain Noise Figure	including 1.6dB SAW-Filter Insertion Loss between LNAOUT and MIX_IN		4		dB
RF_IN_S11	LNA Input Return Loss	50 Ohm Environment		-5		dB

Table 17: RF AC Parameters

3.2.4 Power Consumption¹⁰

Symbol	Parameter	Conditions	Min	Typ	Max	Unit
IDDB_B	VDD_B Backup current	Backup mode, VDD_B=1.2V		25		uA
IDDC_S	VDDC Sleep Core current	Sleep mode, VDDC = 1.2 V		300		uA
IDDC_T	VDDC Tracking Core current	Tracking, Eco Mode, VDDC =1.2V		20		mA
I_RF_S	VDD_RF Sleep RF current	Sleep, VDD_RF =1.8V		0.1		uA
I_RF_T	VDD_RF Tracking RF current	Tracking, VDD_RF =1.8V		21		mA
IDDIO_B	VDD_IO Backup current	Backup mode, VDD_IO=3.3V		20		uA
IDDIO_T	VDD_IO Tracking current	Tracking, VDD_IO =3.3V		300		uA

Table 18: Power Consumption

¹⁰ Maximum Power consumption for IDDC and I_RF is up to 150 mA



Operation beyond the "Operating Conditions" is not recommended and extended exposure beyond the "Operating Conditions" may affect device reliability.

4 Design-in

In order to obtain the necessary information to conduct a proper design-in, u-blox strongly recommends consulting the AMY-5M Hardware Integration Manual [1].

5 Reliability tests and approvals

5.1 Approvals



Products marked with this lead-free symbol on the product label comply with the "Directive 2002/95/EC of the European Parliament and the Council on the Restriction of Use of certain Hazardous Substances in Electrical and Electronic Equipment" (RoHS).

All u-blox 5 GPS modules are RoHS compliant.

6 Product handling

6.1 Packaging

AMY-5M modules are delivered as hermetically sealed, reeled tapes in order to enable efficient production, production lot set-up and tear-down.



Figure 3: Reeled AMY-5M modules

6.1.1 Reels

AMY-5M modules are deliverable in quantities of 2000 pieces/reel.

The dimension of the reel is shown in Figure 4.



Hint: Sample quantities are delivered in trays:

- 10 pieces/tray for prototypes
- 100 pieces/tray for pre-production

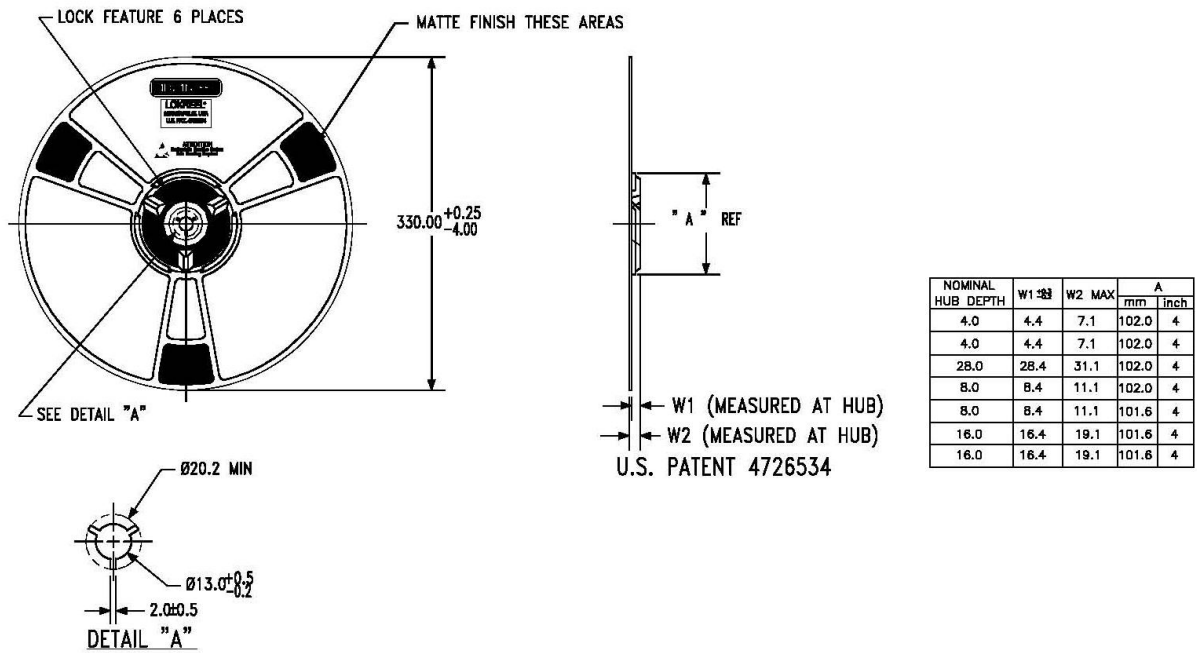

Figure 4: Dimensions of reel

6.1.2 Tapes

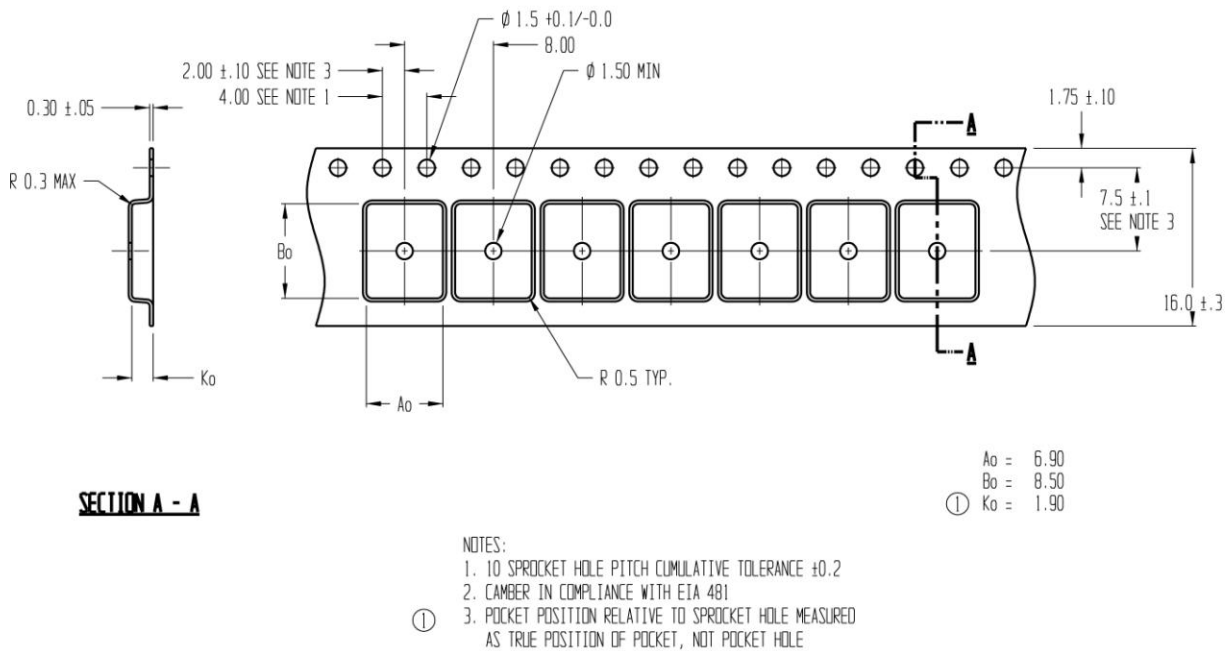

Figure 5: Dimensions for AMY-5M on Tape

6.2 Shipment, storage and handling

AMY-5M is designed and packaged to be processed in an automatic assembly line, and is shipped in Tape-and-Reel.



The AMY-5M module is a Moisture Sensitive Device (MSD) in accordance to the IPC/JEDEC specification. Appropriate MSD handling instructions and precautions are summarized in Sections 6.2.1 to 6.2.3. Read them carefully to prevent permanent damage due to moisture intake.



GPS receivers contain highly sensitive electronic circuitry and are Electrostatic Sensitive Devices (ESD). Handling AMY-5M modules without proper ESD protection may destroy or damage them permanently. See Section 6.2.6 for ESD handling instructions.

6.2.1 Moisture Sensitivity Levels

The Moisture Sensitivity Level (MSL) relates to the packaging and handling precautions required. AMY-5M modules are rated at MSL level 3.



For MSL standard see IPC/JEDEC J-STD-020, which can be downloaded from www.jedec.org.

6.2.2 Shipment

Table 19 summarizes the dry pack requirements for different MSL levels in the IPC/JEDEC specification.

MSL Level	Dry Pack Requirement
1	Optional
2	Required
2a	Required
3	Required
4	Required

Table 19: JEDEC specification of dry pack requirements

According to IPC/JEDEC specification J-STD-020, if a device passes MSL level 1, it is classified as not moisture sensitive and does not require dry pack. If a device fails level 1 but passes a higher numerical level, it is classified as moisture sensitive and must be dry packed in accordance with J-STD-033.

AMY-5M modules are delivered on Tape-and-Reels in a hermetically sealed package ("dry bag") to prevent moisture intake and protect against electrostatic discharge. For protection from physical damage, the reels are individually packed in cartons.

Carrier materials such as trays, tubes, reels, etc., that are placed in the Moisture Barrier Bag (MBB) can affect the moisture level within the MBB. Therefore, the effect of these materials is compensated by adding additional desiccant in the MBB to ensure the shelf life of the SMD packages.

The dry bag provides an IPC/JEDEC compliant MSD label describing the handling requirements to prevent humidity intake. IPC/JEDEC specifications require that MSD sensitive devices be packaged together with a Humidity Indicator Card (HIC) and desiccant to absorb humidity. If no moisture has been absorbed, the three fields in the HIC indicate blue color. Figure 6 shows examples of an MSD label and HIC.



CAUTION
This bag contains
MOISTURE-SENSITIVE DEVICES

LEVEL

3

1. Calculated shelf life in sealed bag: 12 months at <math><40^{\circ}\text{C}</math> and <math><90\%</math> relative humidity (RH)
2. Peak package body temperature: _____ $^{\circ}\text{C}$
3. After this bag is opened, devices that will be subjected to reflow solder or other high temperature process must be
 - a) Mounted within **168** hours of factory conditions <math><30^{\circ}\text{C}</math> / 60% RH, or
 - b) Stored at <math><10\%</math> RH
4. Devices require baking, before mounting, if:
 - a) Humidity Indicator Card is >10% when read at $23^{\circ} \pm 5^{\circ}\text{C}$, or
 - b) 3a or 3b not met
5. If baking is required, devices may be baked for 48 hours at $125^{\circ} \pm 5^{\circ}\text{C}$

Note: If device containers cannot be subjected to high temperature or shorter bake times are desired, reference IPC/JEDEC J-STD-033 for bake procedure.

Bag Seal Date: _____ **01.01.2009**

Note: Level and body temperature defined by IPC/JEDEC J-STD-020

HUMIDITY INDICATOR



EXAMINE ITEM IF PINK		Discard if Circles Overrun Avoid Metal Contact
CHANGE DESICCANT IF PINK		
WARNING IF PINK		

Figure 6: Examples of MSD label and Humidity Indicator Card

6.2.3 Storage and floor life

The calculated shelf life for dry packed SMD packages is a minimum of 12 months from the bag seal date, when stored in a noncondensing atmospheric environment of <math><40^{\circ}\text{C}/90\% \text{ RH}</math>.

Table 20 lists floor life for different MSL levels in the IPC/JDEC specification.

MSL level	Floor life (out of bag) at factory ambient $\leq 30^{\circ}\text{C}/60\% \text{ RH}$ or as stated
1	Unlimited at $\leq 30^{\circ}\text{C}/85\% \text{ RH}$
2	1 year
2a	4 weeks
3	168 hours
4	72 hours

Table 20: JEDEC specification of floor life

The parts must be processed and soldered within the time specified for the MSL level. If this time is exceeded, or the humidity indicator card in the sealed package indicates that they have been exposed to moisture, the devices need to be pre-baked before the reflow solder process.

6.2.4 Drying

Both encapsulant and substrate materials absorb moisture. IPC/JEDEC specification J-STD-020 must be observed to prevent cracking and delamination associated with the "popcorn" effect during reflow soldering. The popcorn effect can be described as miniature explosions of evaporating moisture. Baking before processing is required in the following cases:

- Humidity indicator card: At least one circular indicator is no longer blue
- Floor life or environmental requirements after opening the seal have been exceeded, e.g. exposure to excessive seasonal humidity.

Refer to Section 4 of IPC/JEDEC J-STD-033 for recommended baking procedures. Table 4-1 of the specification lists the required bake times and conditions for drying. For example, a module that has exceeded its floor life by >72 hours shall be baked at 125°C for 9 hours. (Floor life begins counting at time = 0 after bake).



Do not attempt to bake AMY-5M modules while contained in tape and rolled up in reels. For baking, place parts individually onto sample tray.



Oxidation Risk: Baking SMD packages may cause oxidation and/or intermetallic growth of the terminations, which if excessive can result in solderability problems during board assembly. The temperature and time for baking SMD packages are therefore limited by solderability considerations. The cumulative bake time at a temperature greater than 90°C and up to 125°C shall not exceed 96 hours. If the bake temperature is not greater than 90°C , there is no limit on bake time. Bake temperatures higher than 125°C are not allowed.

6.2.5 Reflow soldering

Reflow profiles are to be selected according to IPC/JEDEC J-STD-020.

6.2.6 ESD handling precautions



The AMY-5M module is an Electrostatic Sensitive Devices (ESD). Observe precautions for handling! Failure to observe these precautions can result in severe damage to the GPS receiver!



GPS receivers are Electrostatic Sensitive Devices (ESD) and require special precautions when handling. Particular care must be exercised when handling patch antennas, due to the risk of electrostatic charges. In addition to standard ESD safety practices, the following measures should be taken into account whenever handling the receiver:

- Unless there is a galvanic coupling between the local GND (i.e. the work table) and the PCB GND, then the first point of contact when handling the PCB shall always be between the local GND and PCB GND.
- Before mounting an antenna patch, connect ground of the device
- When handling the RF pin, do not come into contact with any charged capacitors and be careful when contacting materials that can develop charges (e.g. patch antenna ~10pF, coax cable ~50-80pF/m, soldering iron, ...)
- To prevent electrostatic discharge through the RF input do not touch the mounted patch antenna.
- When soldering RF connectors and patch antennas to the receiver's RF pin, make sure to use an ESD safe soldering iron (tip).

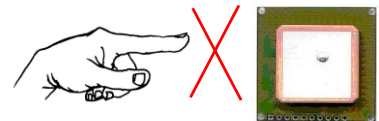
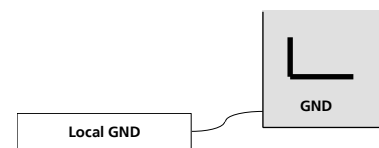

7 Default settings

Interface	Settings
Serial Port 1 Output	9600 Baud, 8 bits, no parity bit, 1 stop bit Configured to transmit both NMEA and UBX protocols, but only following NMEA and no UBX messages have been activated at start-up: GGA, GLL, GSA, GSV, RMC, VTG, TXT
USB Output	Configured to transmit both NMEA and UBX protocols, but only following NMEA and no UBX messages have been activated at start-up: GGA, GLL, GSA, GSV, RMC, VTG, TXT USB Power Mode: Bus-Powered
Serial Port 1 Input	9600 Baud, 8 bits, no parity bit, 1 stop bit Automatically accepts following protocols without need of explicit configuration: UBX, NMEA The GPS receiver supports interleaved UBX and NMEA messages.
USB Input	Automatically accepts following protocols without need of explicit configuration: UBX, NMEA The GPS receiver supports interleaved UBX and NMEA messages. USB Power Mode: Bus-Powered
TIMEPULSE (1Hz Nav)	1 pulse per second, synchronized at rising edge, pulse length 100ms
Power Mode	Maximum Performance Mode¹¹ Eco Mode

Table 21: Available Protocols.(Default settings in bold)

Refer to the AMY-5M Hardware Integration Manual [1] for information about further settings.

¹¹ The operating mode must be set to Eco mode.

8 Labeling and ordering information

8.1 Product labeling

The labeling of u-blox 5 GPS modules includes important product information. The location of the product type number is shown in Figure 7.

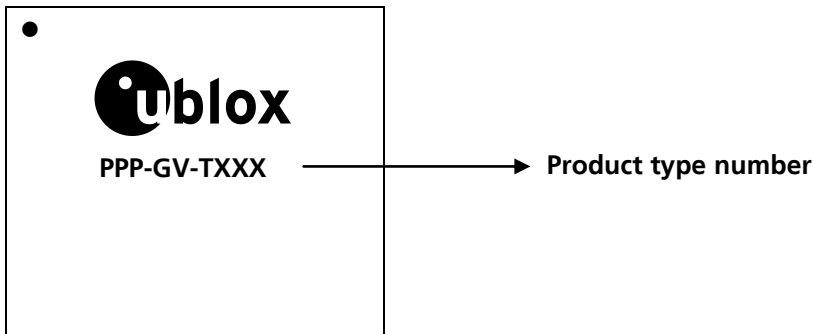

Figure 7: Location of product type number on u-blox 5 module label

8.2 Explanation of codes

3 different product code formats are used. The **Product Name** is used in documentation such as this data sheet and identifies all u-blox 5 products, independent of packaging and quality grade. The **Ordering Code** includes options and quality, while the **Type Number** includes the hardware and firmware versions. Table 22 below details these 3 different formats:

Format	Structure
Product Name	PPP-GV
Ordering Code	PPP-GV-T
Type Number	PPP-GV-TXXX

Table 22: Product Code Formats

The parts of the product code are explained in Table 23.

Code	Meaning	Example
PPP	Product Family	AMY
G	Product Generation	5 = u-blox5
V	Variant	T = Timing, R = DR, etc.
T	Option / Quality Grade	Describes standardized functional element or quality grade such as different RF connector, FLASH size, automotive grade etc.
XXX	Product Detail	Describes product details or options such as hard- and software revision, cable length, etc.

Table 23: part identification code

8.3 Ordering information

Ordering No.	Product
AMY-5M-0	ROM-based u-blox 5 GPS module, 2000 pcs/reel
EVK-5A-0	u-blox 5 Evaluation Kit with SuperSense®

Table 24: Product Ordering Codes



Product changes affecting form, fit or function are documented by u-blox. For a list of Product Change Notifications (PCNs) see our website at: www.u-blox.com.

Related documents

- [1] AMY-5M Hardware Integration Manual, Docu. No GPS.G5-MS5-07005
- [2] u-blox 5 Receiver Description including Protocol Specification, Docu. No GPS.G5-X-07036

All these documents are available on our homepage (<http://www.u-blox.com>).



For regular updates to u-blox documentation and to receive product change notifications please register on our homepage.

Revision history

Revision	Date	Name	Status / Comments
	18/09/2008	tgri	Initial Version
1	09/10/2008	tgri	Features List updated
2	22/10/2008	tgri	Config Pins, RF AC Parameters
3	4/12/2008	tgri	Pinout, Pin Configuration
4	22/12/2008	tgri	Pinout
A	18/09/2009	tgri	New CI, update of status to preliminary, removal of SPI, update of tape description, update of pin description, update of GPS performance table.
A1	9/11/2009	tgri	Minor corrections
A2	1/02/2010	tgri	Section 6.2: MSL level
A3	30/05/2011	cbib	Added max power consumption for LDO dimensioning

Contact

For complete contact information visit us at www.u-blox.com

Headquarters

u-blox AG

Zuercherstrasse 68
CH-8800 Thalwil
Switzerland

Phone: +41 44 722 74 44
Fax: +41 44 722 74 47
E-mail: info@u-blox.com

Offices

North, Central and South America

u-blox America, Inc.

Phone: +1 (703) 483 3180
E-mail: info_us@u-blox.com

Regional Office West Coast:

Phone: +1 (703) 483 3184
E-mail: info_us@u-blox.com

Technical Support:

Phone: +1 (703) 483 3185
E-mail: support_us@u-blox.com

Europe, Middle East, Africa

u-blox AG

Phone: +41 44 722 74 44
E-mail: info@u-blox.com

Technical Support:

Phone: +41 44 722 74 44
E-mail: info@u-blox.com

Asia, Australia, Pacific

u-blox Singapore Pte. Ltd.

Phone: +65 6734 3811
E-mail: info_ap@u-blox.com
Support: support_ap@u-blox.com

Regional Office China:

Phone: +86 10 68 133 545
E-mail: info_cn@u-blox.com
Support: support_cn@u-blox.com

Regional Office Japan:

Phone: +81 3 5775 3850
E-mail: info_jp@u-blox.com
Support: support_jp@u-blox.com

Regional Office Korea:

Phone: +82 2 542 0861
E-mail: info_kr@u-blox.com
Support: support_kr@u-blox.com

Regional Office Taiwan:

Phone: +886 2 2657 1090
E-mail: info_tw@u-blox.com
Support: support_tw@u-blox.com