



N- and P-Channel 20-V (D-S) MOSFET

CHARACTERISTICS

- N- and P-Channel Vertical DMOS
- Macro Model (Subcircuit Model)
- Level 3 MOS
- Apply for both Linear and Switching Application
- Accurate over the -55 to 125°C Temperature Range
- Model the Gate Charge, Transient, and Diode Reverse Recovery Characteristics

DESCRIPTION

The attached spice model describes the typical electrical characteristics of the n- and p-channel vertical DMOS. The subcircuit model is extracted and optimized over the -55 to 125°C temperature ranges under the pulsed 0-V to 5-V gate drive. The saturated output impedance is best fit at the gate bias near the threshold voltage.

A novel gate-to-drain feedback capacitance network is used to model the gate charge characteristics while avoiding convergence difficulties of the switched C_{gd} model. All model parameter values are optimized to provide a best fit to the measured electrical data and are not intended as an exact physical interpretation of the device.

SUBCIRCUIT MODEL SCHEMATIC

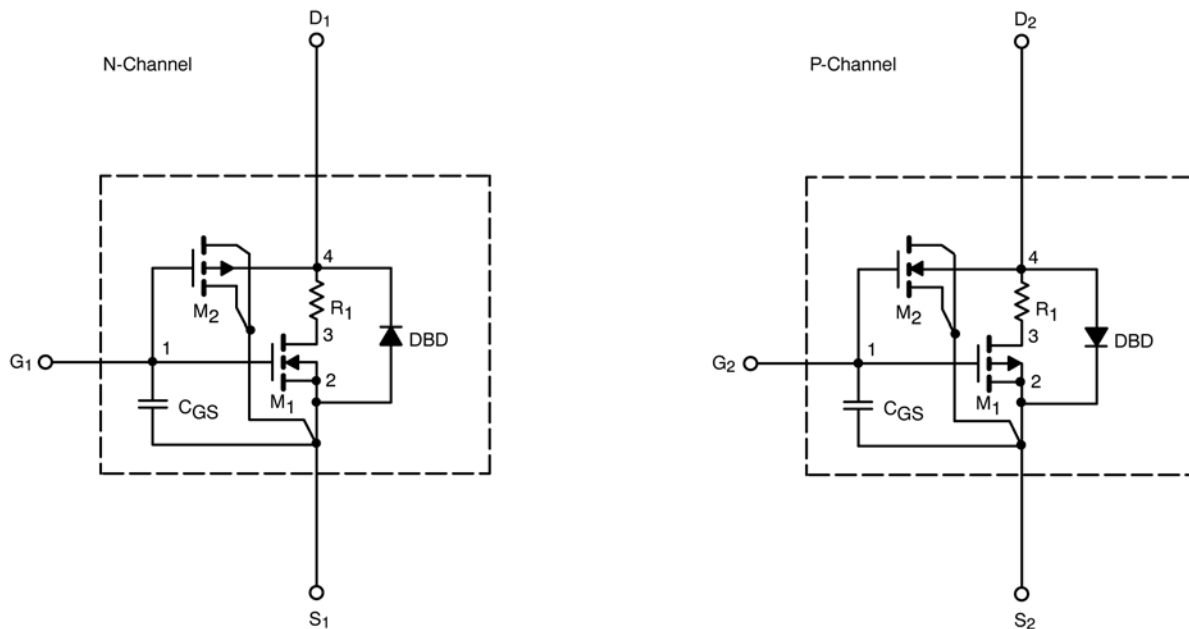

This document is intended as a SPICE modeling guideline and does not constitute a commercial product data sheet. Designers should refer to the appropriate data sheet of the same number for guaranteed specification limits.



SPECIFICATIONS ($T_J = 25^\circ\text{C}$ UNLESS OTHERWISE NOTED)						
Parameter	Symbol	Test Condition		Simulated Data	Measured Data	Unit
Static						
Gate Threshold Voltage	$V_{GS(th)}$	$V_{DS} = V_{GS}, I_D = 250 \mu\text{A}$	N-Ch	0.70		V
		$V_{DS} = V_{GS}, I_D = -250 \mu\text{A}$	P-Ch	0.78		
On-State Drain Current ^a	$I_{D(on)}$	$V_{DS} \geq 5 \text{ V}, V_{GS} = 4.5 \text{ V}$	N-Ch	111		A
		$V_{DS} \leq -5 \text{ V}, V_{GS} = -4.5 \text{ V}$	P-Ch	47		
Drain-Source On-State Resistance ^a	$r_{DS(on)}$	$V_{GS} = 4.5 \text{ V}, I_D = 3.4 \text{ A}$	N-Ch	0.048	0.047	Ω
		$V_{GS} = -4.5 \text{ V}, I_D = -2.5 \text{ A}$	P-Ch	0.088	0.086	
		$V_{GS} = 2.5 \text{ V}, I_D = 3.2 \text{ A}$	N-Ch	0.056	0.054	
		$V_{GS} = -2.5 \text{ V}, I_D = -2 \text{ A}$	P-Ch	0.120	0.116	
Forward Transconductance ^a	g_{fs}	$V_{DS} = 5 \text{ V}, I_D = 3.4 \text{ A}$	N-Ch	12	13	S
		$V_{DS} = -5 \text{ V}, I_D = -2.5 \text{ A}$	P-Ch	6.4	6	
Diode Forward Voltage ^a	V_{SD}	$I_S = 1.05 \text{ A}, V_{GS} = 0 \text{ V}$	N-Ch	0.80	0.80	V
		$I_S = -1.05 \text{ A}, V_{GS} = 0 \text{ V}$	P-Ch	-0.78	-0.80	
Dynamic^b						
Total Gate Charge	Q_g	N-Channel $V_{DS} = 10 \text{ V}, V_{GS} = 4.5 \text{ V}, I_D = 3.4 \text{ A}$ P-Channel $V_{DS} = -10 \text{ V}, V_{GS} = -4.5 \text{ V}, I_D = -2.5 \text{ A}$	N-Ch	4.1	4.1	Nc
Gate-Source Charge	Q_{gs}		P-Ch	4	5	
			N-Ch	0.65	0.65	
Gate-Drain Charge	Q_{gd}		P-Ch	0.68	0.68	
			N-Ch	0.90	0.90	
			P-Ch	0.90	0.90	
Turn-On Delay Time	$t_{d(on)}$	N-Channel $V_{DD} = 10 \text{ V}, R_L = 10 \Omega$ $I_D \cong 1 \text{ A}, V_{GEN} = 4.5 \text{ V}, R_G = 6 \Omega$ P-Channel $V_{DD} = -10 \text{ V}, R_L = 10 \Omega$ $I_D \cong -1 \text{ A}, V_{GEN} = -4.5 \text{ V}, R_G = 6 \Omega$	N-Ch	29	30	Ns
Rise Time	t_r		P-Ch	45	28	
			N-Ch	52	52	
Turn-Off Delay Time	$t_{d(off)}$		P-Ch	53	55	
			N-Ch	27	25	
Fall Time	t_f		P-Ch	69	55	
			N-Ch	27	20	
			P-Ch	11	32	

Notes

- a. Pulse test; pulse width $\leq 300 \mu\text{s}$, duty cycle ≤ 2 .
- b. Guaranteed by design, not subject to production testing.



SPICE Device Model Si3586DV

Vishay Siliconix

COMPARISON OF MODEL WITH MEASURED DATA ($T_J=25^\circ\text{C}$ UNLESS OTHERWISE NOTED)

N-Channel MOSFET

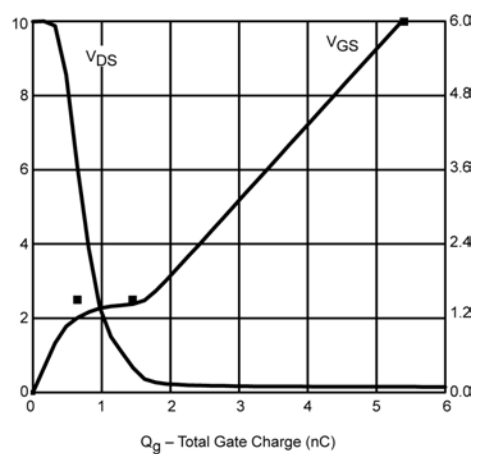
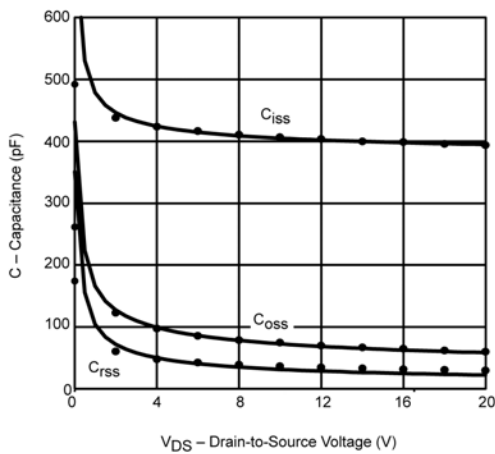
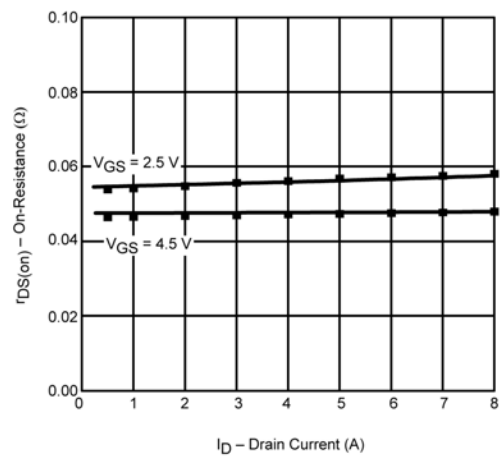
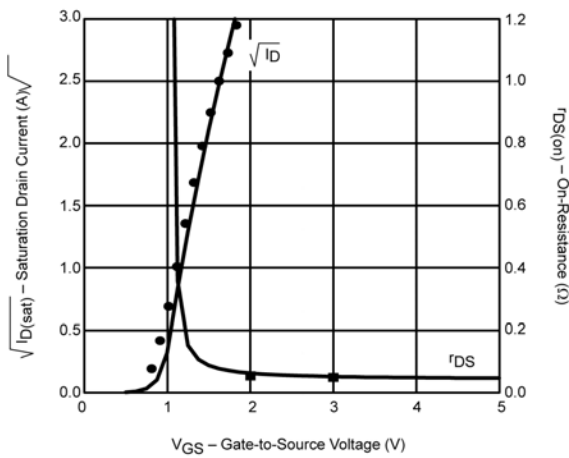
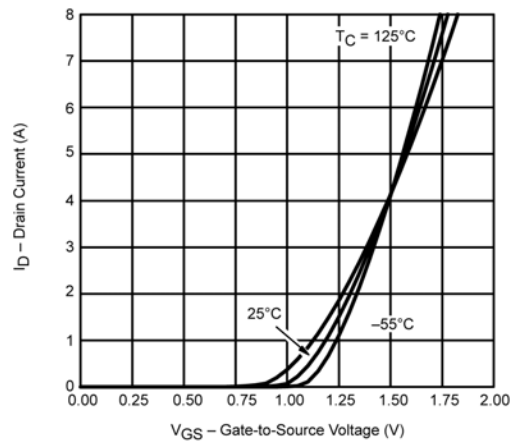
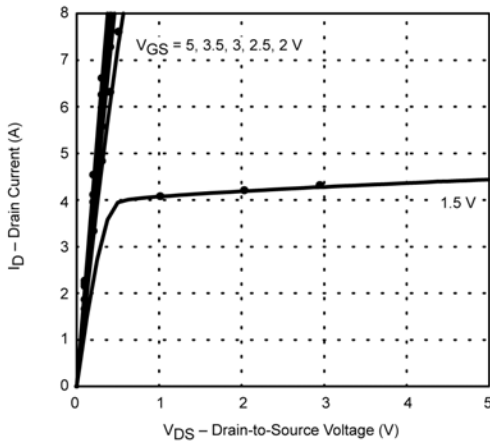

Note: Dots and squares represent measured data.

SPICE Device Model Si3586DV

Vishay Siliconix



P-Channel MOSFET

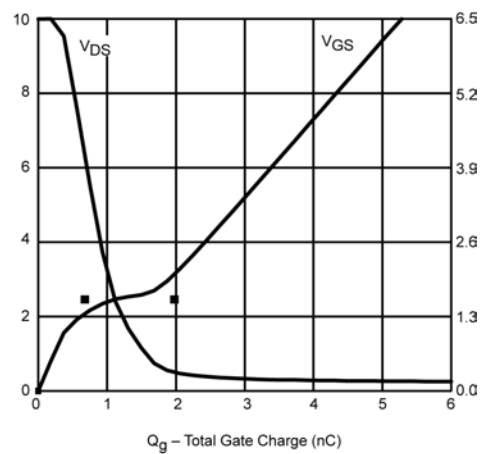
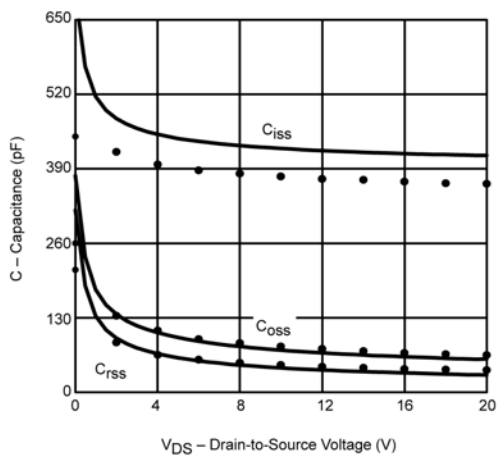
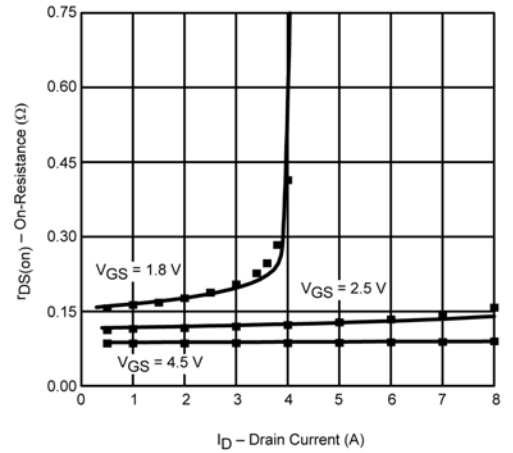
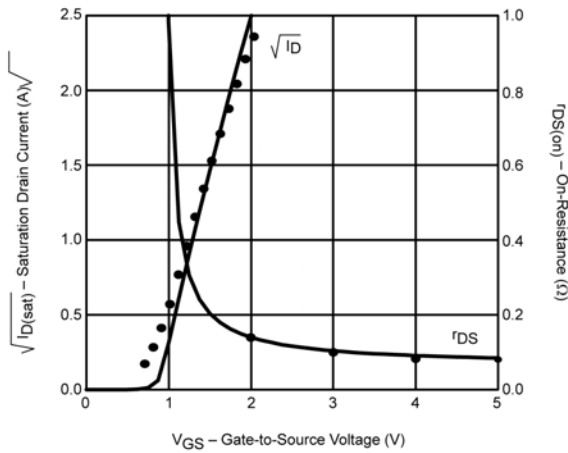
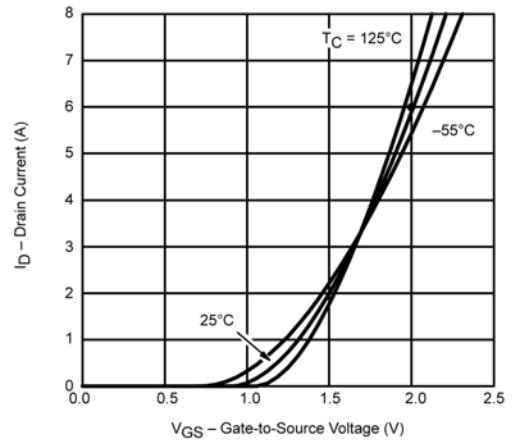
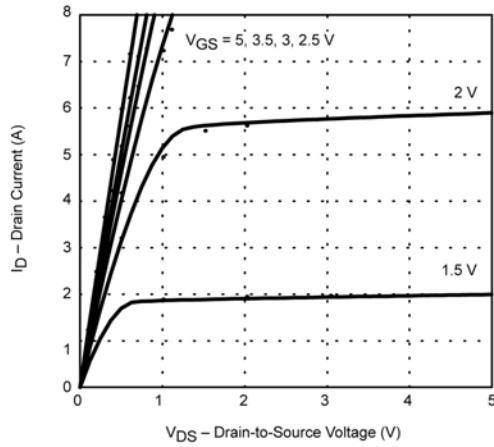

Note: Dots and squares represent measured data.