

DATA SHEET

SKY65116: 390–500 MHz Linear Power Amplifier

Applications

- TETRA radio
- GSM450 and GSM480
- NMT450
- Wireless local loop
- UHF TV broadcast

Features

- Wideband frequency operation: 390–500 MHz
- High linearity: OIP3 43 dBm
- High efficiency: 40% PAE
- High gain: 35 dB
- $P_{1\text{ dB}} = 32.5\text{ dBm}$
- Single DC supply: 3.6 V
- Internal RF match and bias circuits
- PA on/off voltage control
- Operating temperature $-40\text{ }^{\circ}\text{C}$ to $+85\text{ }^{\circ}\text{C}$
- Available on tape and reel
- Low cost MCM 12-pin ($8 \times 8\text{ mm}$) package
- Available lead (Pb)-free and RoHS-compliant MSL-3, $260\text{ }^{\circ}\text{C}$ per JEDEC J-STD-020

NEW

Skyworks offers lead (Pb)-free, RoHS (Restriction of Hazardous Substances)-compliant packaging.



Description

The Skyworks SKY65116 is a fully matched, 12-pin, $8 \times 8\text{ mm}^2$, surface mount Multi-Chip Module (MCM), linear Power Amplifier (PA), high linearity and high efficiency surface mount module designed for use in the 390–500 MHz band.

The device is fabricated using Skyworks high reliability Gallium Arsenide (GaAs) Heterojunction Bipolar Transistor (HBT) process, which allows for single supply operation while maintaining high efficiency and good linearity. Microwave Monolithic Integrated Circuits (MMICs), comprised of GaAs and Silicon CMOS, contain

all the active circuitry in the module. This includes the in-module bias circuitry, as well as the RF interstage matching circuit. The input and output match is realized off-chip within the module package to optimize efficiency and high power performance ($P_{1\text{ dB}} = 32.5\text{ dBm}$) into a $50\ \Omega$ load.

Primary bias to the SKY65116 can be supplied directly from a single cell lithium-ion or other suitable battery with a nominal output of 3.6 V. No external supply side switch is needed as typical “off” leakage is a few microamperes with full primary voltage supplied from the battery.

The module can operate over the temperature range of $-40\text{ }^{\circ}\text{C}$ to $+85\text{ }^{\circ}\text{C}$. A populated evaluation board is available upon request.

Block Diagram

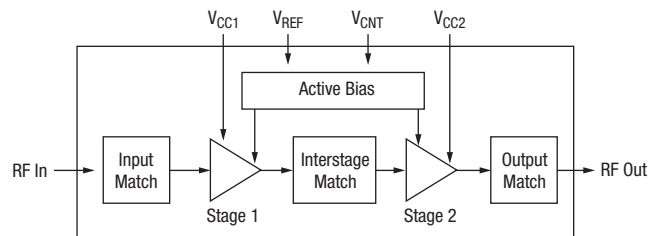

Package Diagram

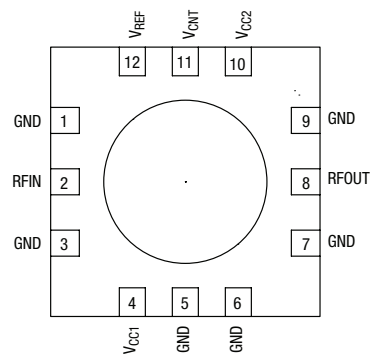

Operating Characteristics

V_{CC1}, V_{CC2}, V_{REF}, V_{CNT} = 3.6 V, T_C = 25 °C, Z₀ = 50 Ω, unless otherwise specified

Parameter	Symbol	Condition	Min	Typ	Max	Units
Frequency	F		390		500	MHz
Quiescent current	I _{CQ}	No RF	0.1	0.33	0.375	A
Small signal gain	G	P _{IN} = -15 dBm	33.5	35		dB
Input return loss	S ₁₁	P _{IN} = -15 dBm	10	22		dB
Output return loss	S ₂₂	P _{IN} = -15 dBm	4.5	6		dB
Output power	P _{OUT}	@ P ₁ dB	31.5	32.5		dBm
Power added efficiency	PAE	P _{OUT} @ P ₁ dB	35	42		%
Output IP3	OIP3	P _{OUT} = 25 dBm/tone	38	43		dBm
Noise figure	NF	P _{IN} = -15 dBm		6	7.5	dB
Thermal resistance	Θ _{JC}	Junction to case		17.6		°C/W

Absolute Maximum Ratings

Characteristic	Value
RF output power	34.5 dBm
Supply voltage (V _{CC} , V _{REF} , V _{CNT})	4.5 V
Supply current (I _{CC})	1300 mA
Power dissipation (P _{DISS})	3.7 W
Operating case temperature (T _C)	-40 °C to +85 °C
Storage temperature (T _{ST})	-55 °C to +125 °C
Junction temperature (T _J)	150 °C

Performance is guaranteed only under the conditions listed in the specifications table and is not guaranteed under the full range(s) described by the Absolute Maximum specifications. Exceeding any of the absolute maximum/minimum specifications may result in permanent damage to the device and will void the warranty. Each absolute maximum rating listed is an individual parameter. Biasing and driving the amplifier with more than one absolute maximum rating listed may result in permanent damage to the device. Exposure to maximum rating conditions for extended periods may reduce device reliability.

CAUTION: *Although this device is designed to be as robust as possible, Electrostatic Discharge (ESD) can damage this device. This device must be protected at all times from ESD. Static charges may easily produce potentials of several kilovolts on the human body or equipment, which can discharge without detection. Industry-standard ESD precautions should be employed at all times.*

Recommended Operating Conditions

Parameter	Symbol	Min.	Typ.	Max.	Unit
Supply voltage	V_{CC}	3.2	3.6	4	V
Reference voltage	V_{REF}	3.2	3.6	4	V
Control voltage (power up)	V_{CNT}	2.7	3.6		V
Control voltage (power down)	V_{CNT}		0	0.5	V
Operating frequency	F_0	390		500	MHz
Operating case temperature	T_C	-40	+25	+85	$^{\circ}C$

Typical Performance Data

V_{CC1} , V_{CC2} , V_{REF} , $V_{CNT} = 3.6\text{ V}$, $T_C = 25\text{ }^{\circ}C$, $Z_0 = 50\text{ }\Omega$, unless otherwise specified

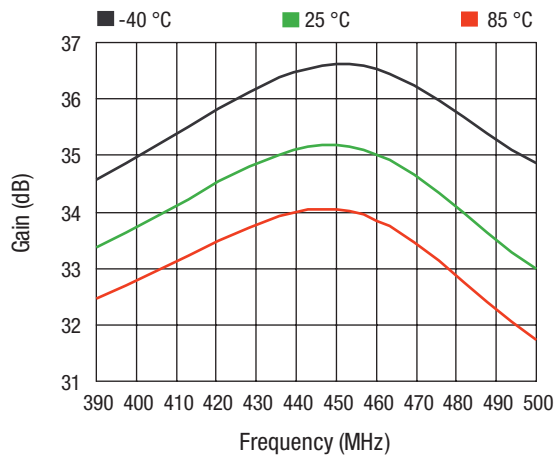

Gain vs. Frequency Across Temperature

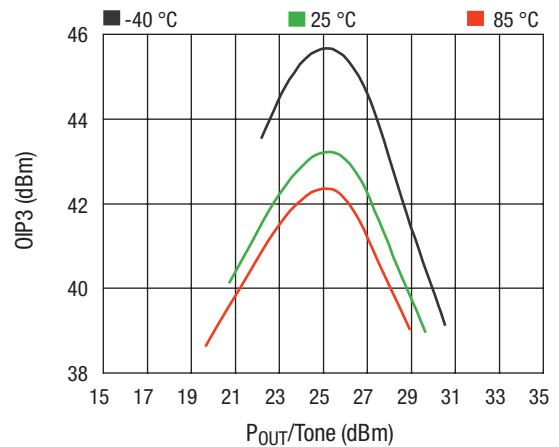

OIP3 vs. P_{OUT}/Tone Across Temperature

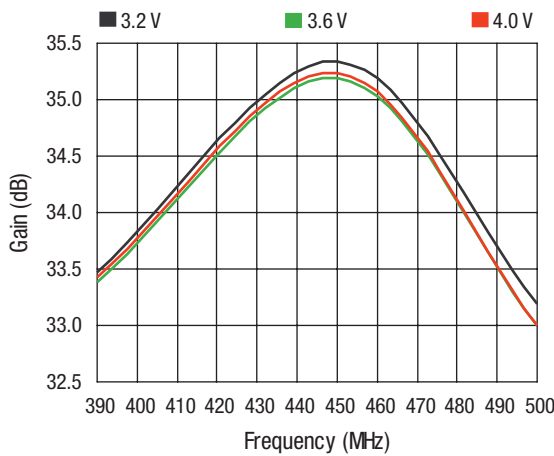

Gain vs. Frequency Across Voltage

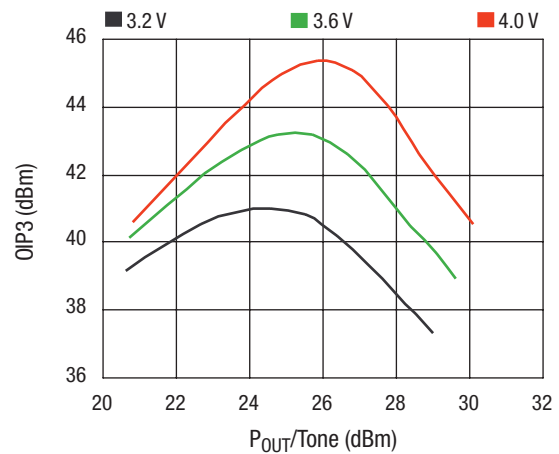

OIP3 vs. P_{OUT}/Tone Across Voltage

Typical Performance Data

V_{CC1} , V_{CC2} , V_{REF} , $V_{CNT} = 3.6\text{ V}$, $T_C = 25\text{ }^\circ\text{C}$, $Z_0 = 50\text{ }\Omega$, unless otherwise specified

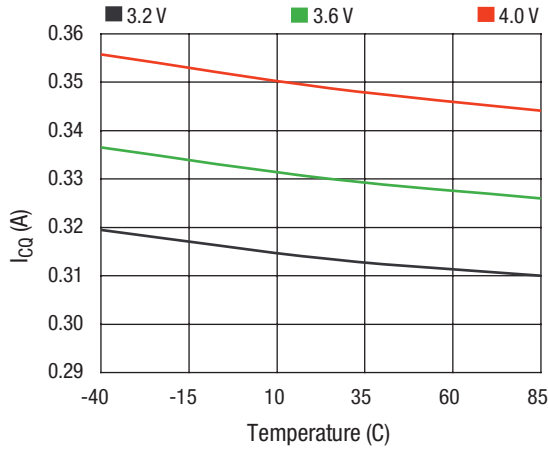

I_{cq} vs. Temperature Across Voltage

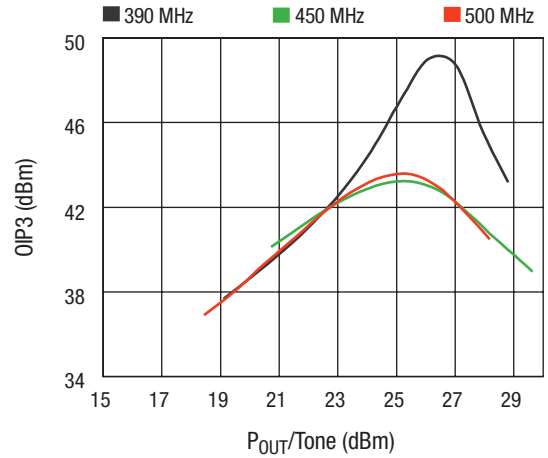

OIP3 vs. P_{OUT}/Tone Across Frequency

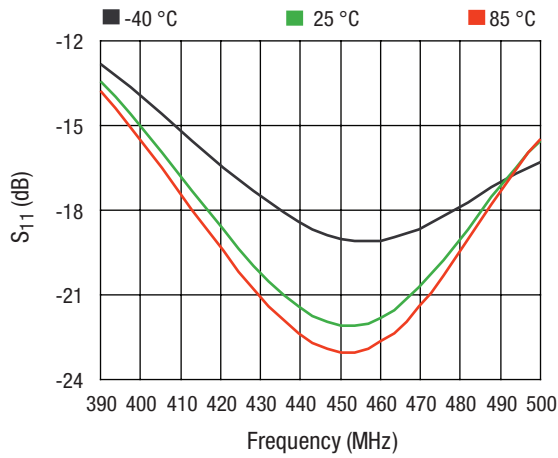

S₁₁ vs. Frequency Across Temperature

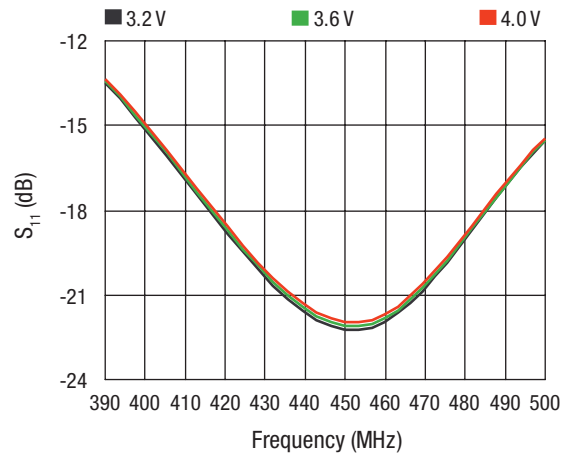

S₁₁ vs. Frequency Across V_{CC}

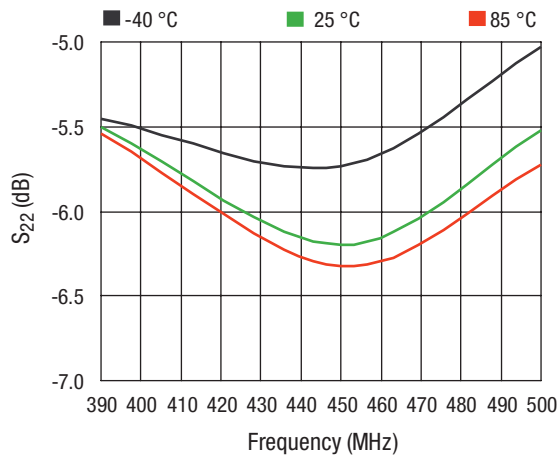

S₂₂ vs. Frequency Across Temperature

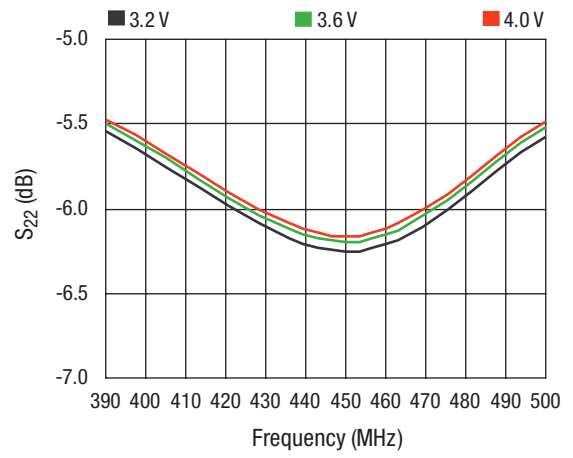

S₂₂ vs. Frequency Across V_{CC}

Typical Performance Data

V_{CC1} , V_{CC2} , V_{REF} , $V_{CNT} = 3.6\text{ V}$, $T_C = 25\text{ }^\circ\text{C}$, $Z_0 = 50\ \Omega$, unless otherwise specified

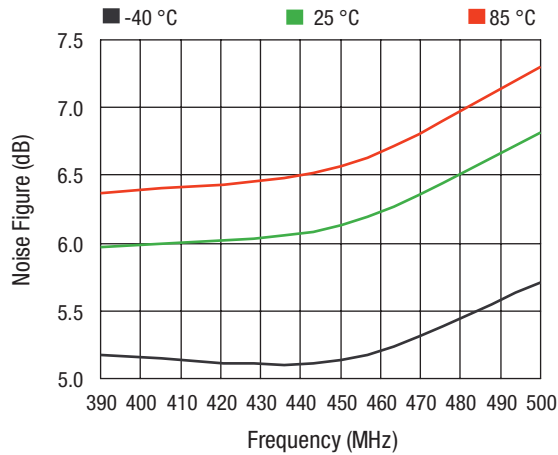

NF vs. Frequency Across Temperature

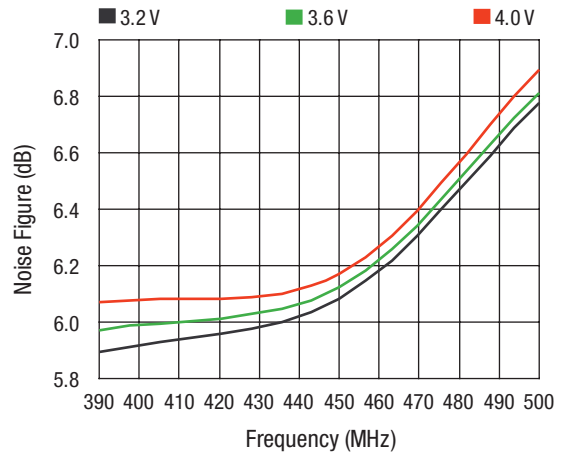

NF vs. Frequency Across V_{CC}

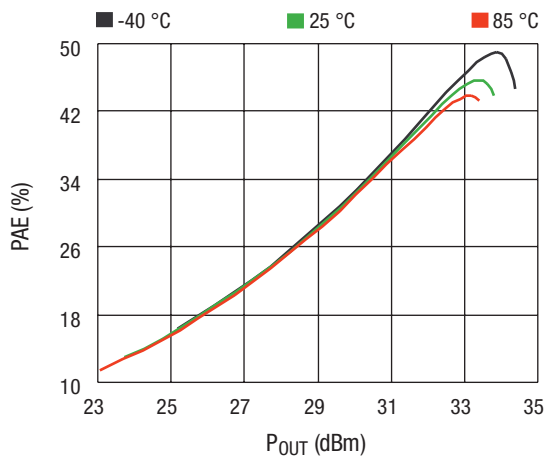

PAE vs. P_{OUT} Across Temperature

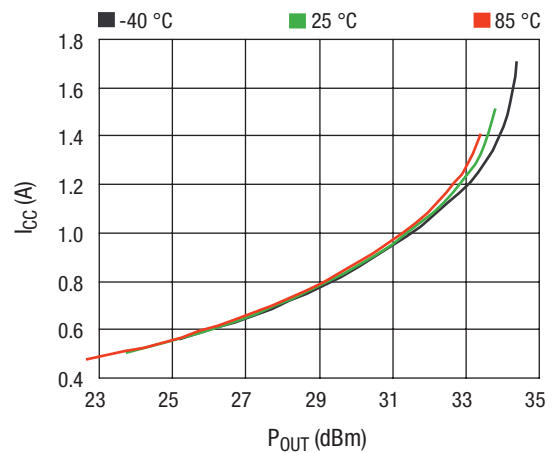

I_{CC} vs. P_{OUT} Across Temperature

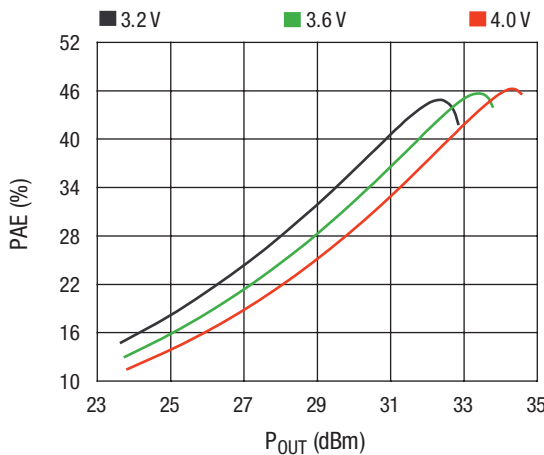

PAE vs. P_{OUT} Across V_{CC}

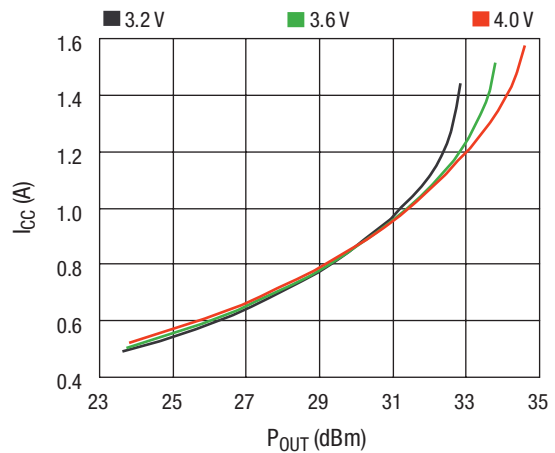

I_{CC} vs. P_{OUT} Across V_{CC}

Typical Performance Data

V_{CC1} , V_{CC2} , V_{REF} , $V_{CNT} = 3.6\text{ V}$, $T_C = 25\text{ }^\circ\text{C}$, $Z_0 = 50\text{ }\Omega$, unless otherwise specified

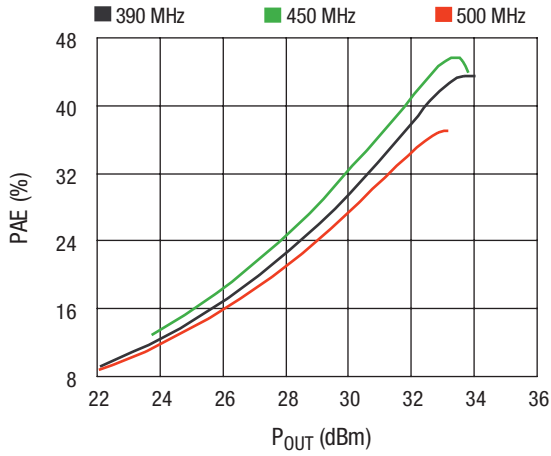

PAE vs. P_{OUT} Across Frequency

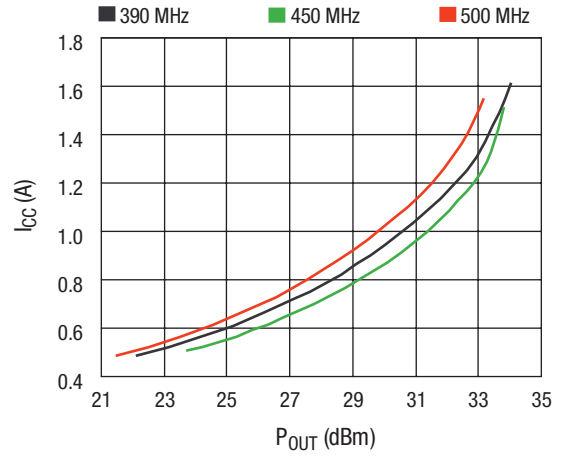

I_{CC} vs. P_{OUT} Across Frequency

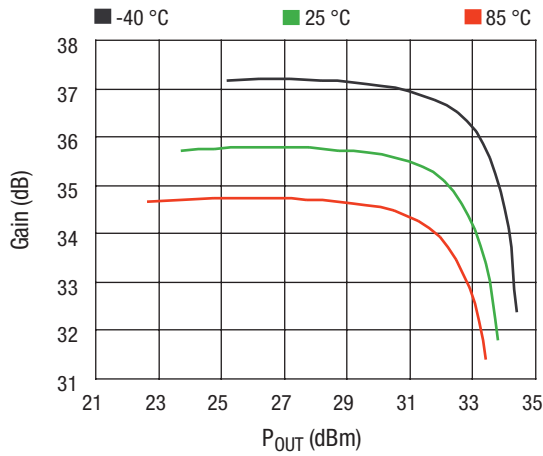

Gain vs. P_{OUT} Across Temperature

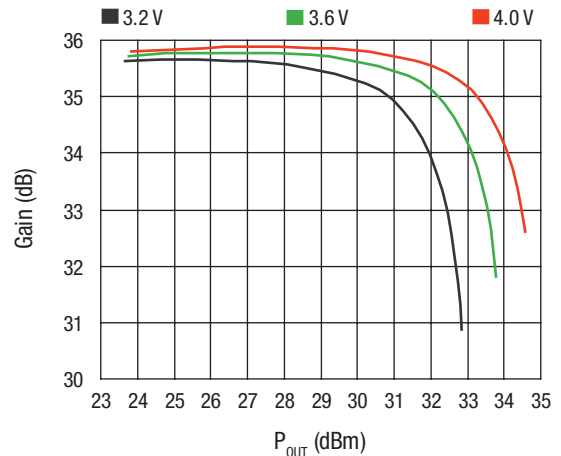

Gain vs. P_{OUT} Across V_{CC}

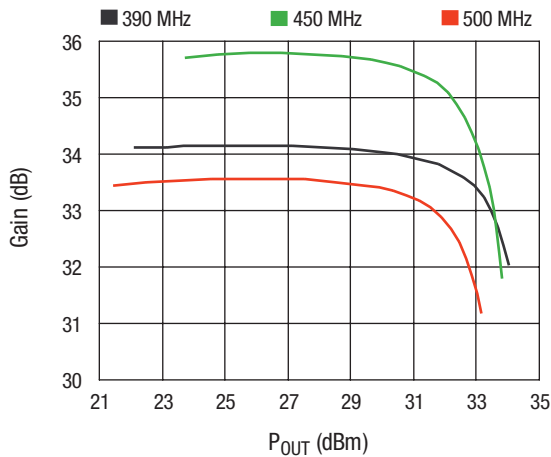

Gain vs. P_{OUT} Across Frequency

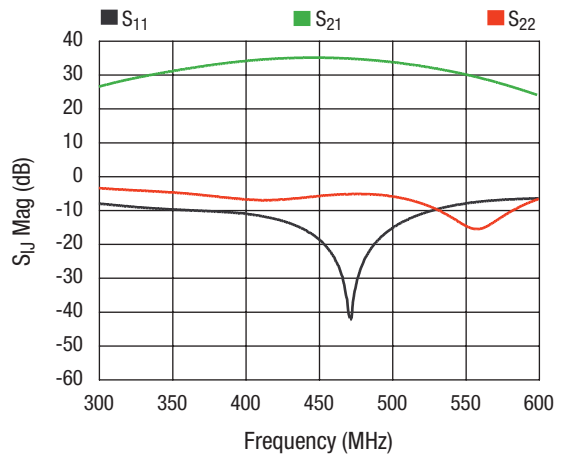

S-Parameters vs. Frequency

Typical Performance Data

V_{CC1} , V_{CC2} , V_{REF} , $V_{CNT} = 3.6\text{ V}$, $T_C = 25\text{ }^\circ\text{C}$, $Z_0 = 50\text{ }\Omega$, unless otherwise specified

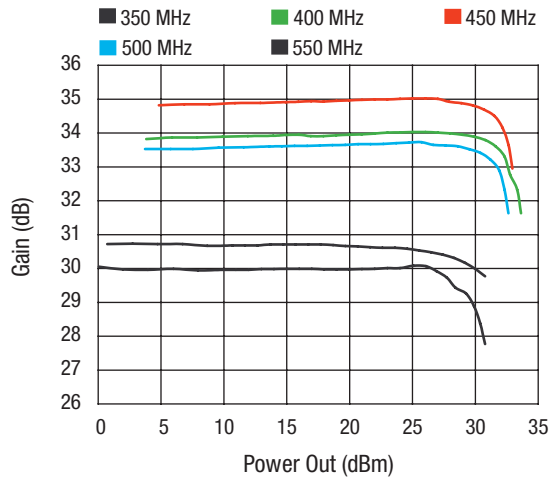

Gain vs. CW Power Out

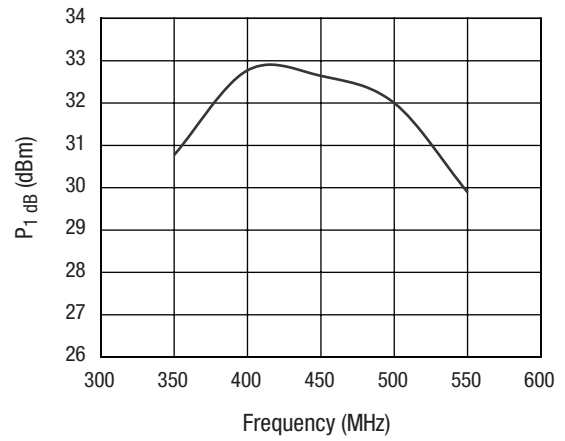

P₁ dB vs. Frequency

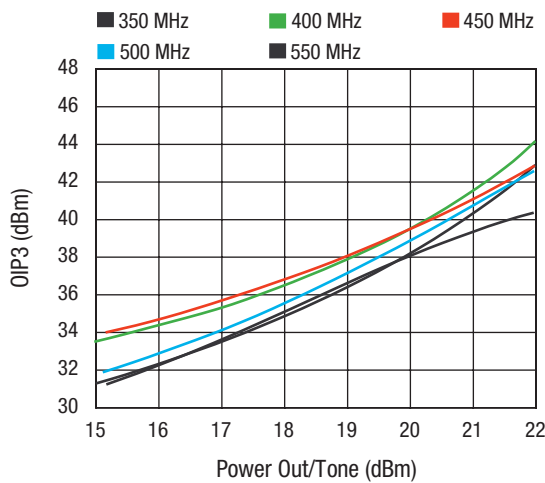

OIP3 vs. P_{OUT}/Tone Across Frequency
Tone Spacing = 1 MHz

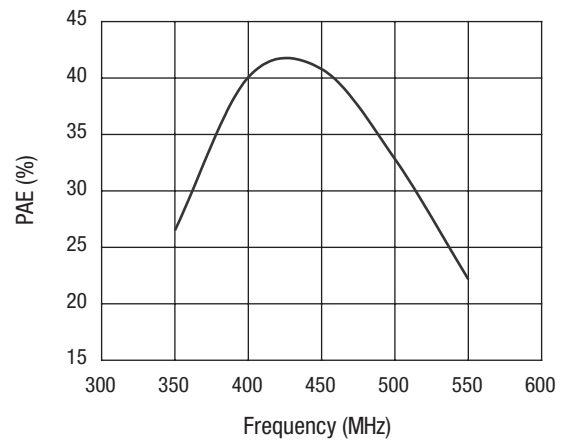

PAE @ P₁ dB vs. Frequency

DC/RF Response Time

$V_{CC1}, V_{CC2}, V_{REF} = 3.6\text{ V}, V_{CNT} = 0/3.6\text{ V}, T_A = 25\text{ }^\circ\text{C}$ unless otherwise specified

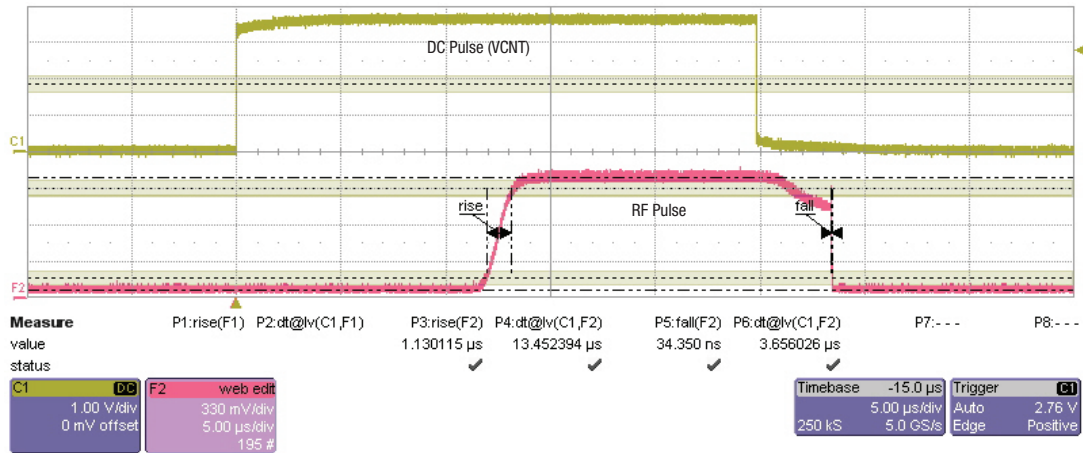

Pulse	%	Label	Rise/Fall	Time
RF-RF	10-90	P3	Rise	1.13 μs
DC-RF	50-90	P4	Rise	13.45 μs
RF-RF	90-10	P5	Fall	0.034 μs
DC-RF	50-10	P6	Fall	3.66 μs

10 μF capacitor, C2 and 0.01 μF capacitor, C5 removed for rise-fall time measurements. Their purpose is to filter DC noise < 200 MHz due to long bias leads to power supply. No noise observed with the removal of C2 and C5.

Theory of Operation

The SKY65116 is comprised of two amplifier stages, and is internally matched for optimum linearity and efficiency. The matching circuits for the input stage, inter-stage, and output stage are contained within the device. An on-chip active bias circuit is included within the device for both input and output stages providing for excellent gain tracking over temperature and voltage variations. The module operates with all positive DC voltages while maintaining high efficiency and good linearity. The nominal operating voltage is 3.6 V for maximum power, but can be operated at slightly lower voltages for other mobile applications.

The input and output stages are independently supplied using the V_{CC1} and V_{CC2} supply lines, pins 4 and 10, respectively. The bias reference voltage is supplied using a common V_{REF} (pin 12) line.

The module includes a silicon CMOS controller circuit to provide an amplifier On/Off operation. V_{CNT} (pin 11) is the PA on/off control voltage to the CMOS controller for stages 1 and 2. 0 V = Off, 3.6 V = On. Nominal “On” operating range is between 2.7 to 3.6 V_{DC} . V_{CNT} set to 0 V_{DC} will force the amplifier into off mode, drawing only microamperes of current.

Application Circuit Notes

Center Ground. It is extremely important that the device paddle be sufficiently grounded for both thermal and stability reasons. Multiple small vias are acceptable and will work well under the device if solder migration is an issue.

Ground (Pins 1, 3, 5, 6, 7, 9). Attach all ground pins to the RF ground plane with the largest diameter and lowest inductance via that the layout will allow. Multiple small vias are also acceptable and will work well under the device if solder migration is an issue.

RF_IN (Pin 2). Amplifier RF Input Pin. $Z_0 = 50 \Omega$. The module includes an onboard internal DC blocking capacitor. All impedance matching is provided internal to the module.

V_{CC1} (Pin 4). Supply voltage for the first stage collector bias (typically 3.6 V). Bypassing of V_{CC1} is accomplished with C7 and C8 and should be placed in the approximate location shown on the evaluation board, but placement is not critical.

RF_OUT (Pin 8). Amplifier RF Output Pin. $Z_0 = 50 \Omega$. The module includes an onboard internal DC blocking capacitor. All impedance matching is provided internal to the module.

V_{CC2} (Pin 10). Supply voltage for the output (final) stage collector bias (typically 3.6 V). Bypassing of V_{CC2} is accomplished with C1 and C4 and should be placed in the approximate location shown on the evaluation board, but placement is not critical.

V_{CNT} (Pin 11). V_{CNT} is the PA on/off control voltage to the silicon CMOS controller for stages 1 and 2. 0 V = Off, 3.6 V = On. Nominal “On” operating range is between 2.7 to 3.6 V_{DC} . V_{CNT} set to 0 V_{DC} will force the amplifier into standby mode.

V_{REF} (Pin 12). Bias reference voltage for amplifier stages 1 and 2. V_{REF} should be operated over the same voltage range as V_{CC} , with a nominal voltage of 3.6 V.

Package and Handling Information

Since the device package is sensitive to moisture absorption, it is baked and vacuum packed before shipping. Instructions on the shipping container label regarding exposure to moisture after the container seal is broken must be followed. Otherwise, problems related to moisture absorption may occur when the part is subjected to high temperature during solder assembly.

Please refer to Skyworks solder reflow application note, available at www.skyworksinc.com, for instructions on mounting the SKY65116 to a printed circuit board.

Production quantities of this product are shipped in a standard tape and reel format. For packaging details, refer to the Skyworks Application Note, Tape and Reel, document number 101568.

Electrostatic Discharge (ESD) Sensitivity

The SKY65116 is a static-sensitive electronic device. Do not operate or store near strong electrostatic fields. Take proper ESD precautions.

Application Circuit

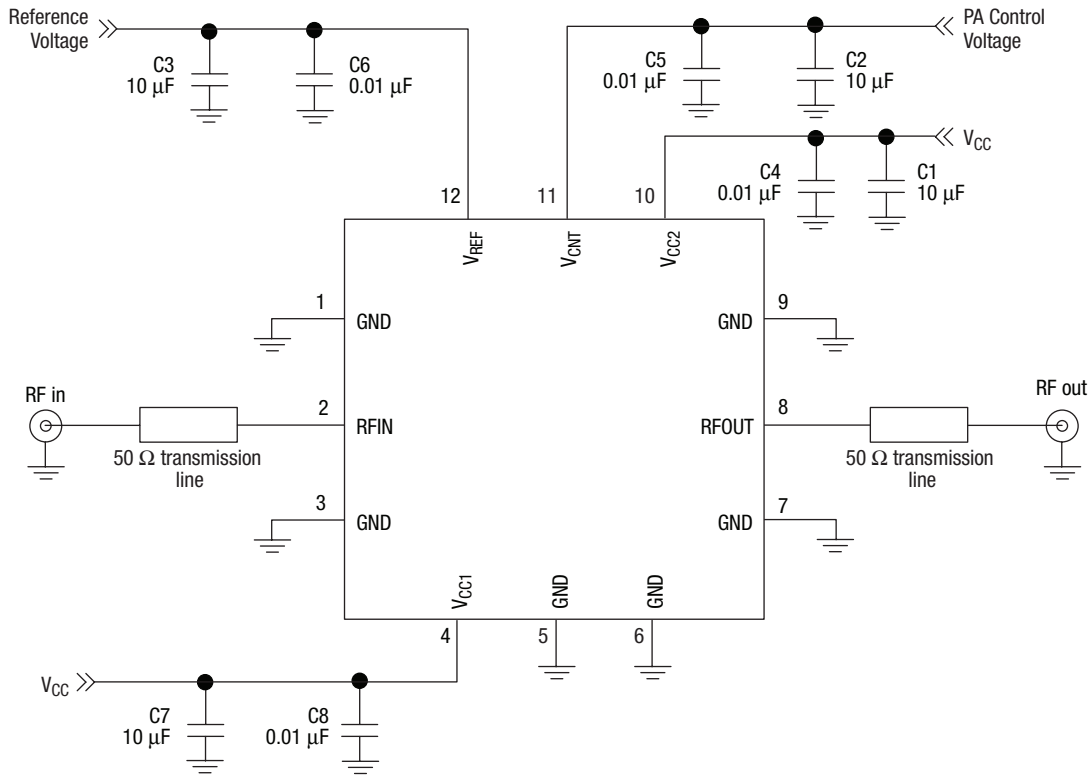

Pin Assignments

Pin #	Name	Description
1	GND	Ground
2	RFIN	RF input
3	GND	Ground
4	V _{CC1}	Stage 1 collector voltage
5	GND	Ground
6	GND	Ground
7	GND	Ground
8	RFOUT	RF output
9	GND	Ground
10	V _{CC2}	Stage 2 collector voltage
11	V _{CNT}	PA on/off control voltage
12	V _{REF}	Bias reference voltage

Center attachment pad must have a low inductance and low thermal resistance connection to the customer's printed circuit board ground plane.

Evaluation Board Description

The Skyworks SKY65116 evaluation board is used to test the performance of the SKY65116 power amplifier module. The following design considerations are general in nature and must be followed regardless of final use or configuration.

1. Paths to ground should be made as short as possible.
2. The ground pad of the SKY65116 power amplifier module has special electrical and thermal grounding requirements. This pad is the main thermal conduit for heat dissipation. Since the circuit board acts as the heat sink, it must shunt as much heat as possible from the amplifiers. As such, design the connection to the ground pad to dissipate the maximum wattage produced to the circuit. Multiple vias to the grounding layer are required.
3. Two external output bypass capacitors (0.01 μF and 10 μF) are required on the V_{CC1} (pin 4) supply input. The same two capacitor values are also required on the V_{CC2} (pin 10) supply input and on the V_{REF} input (pin 12). Each of these capacitors should be placed in parallel between the supply line and ground.
4. V_{CC1} (pin 4) and V_{CC2} (pin 10) may be connected together at the supply.

NOTE: Junction temperature (T_j) of the device increases with a poor connection to the slug and ground. This reduces the lifetime of the device.

Evaluation Board Test Procedure

Use the following procedure to set up the SKY65116 evaluation board for testing:

1. Connect a 3.6 V supply to V_{CC1} and V_{CC2} , and 3.6 V supply to V_{REF} and V_{CNT} . If available, enable the current limiting function of the V_{CC} power supply to 1.5 A.
2. Connect a signal generator to the RF signal input port. Set it to the desired RF frequency at a power level of 2 dBm or less to the evaluation board but do NOT enable the RF signal.
3. Connect a spectrum analyzer to the RF signal output port.
4. Enable the power supply.
5. Enable the RF signal.
6. Take measurements.

NOTE: It is important that the V_{CC1} and V_{CC2} voltage source be adjusted such that 3.6 V is measured at the board. The high collector currents will drop the collector voltage significantly if long leads are used. Adjust the bias voltage to compensate.

Evaluation Board

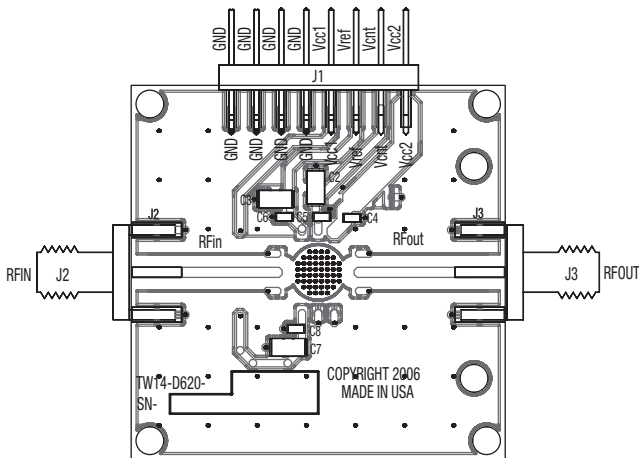

Evaluation Board Layer Detail

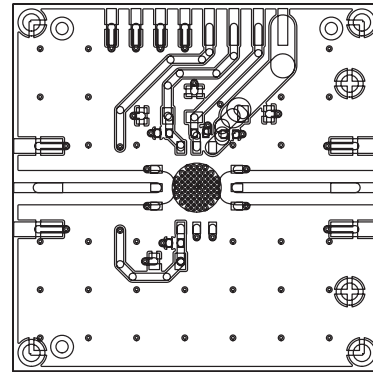

Layer 1: Top -- Metal

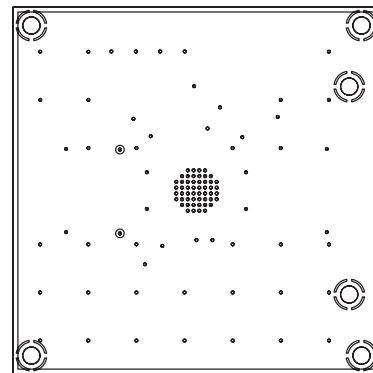

Layer 2: Ground

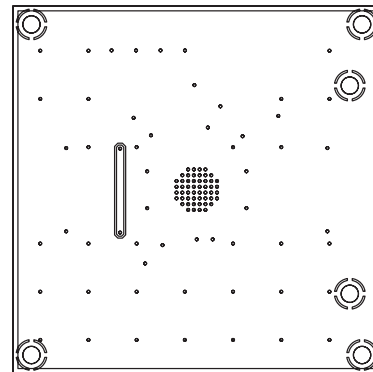

Layer 3: Ground

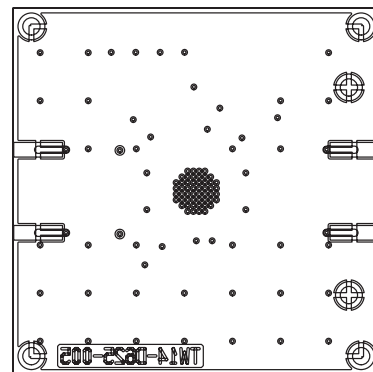

Layer 4: Solid Ground Plane

Recommended Solder Reflow Profiles

Refer to the [“Recommended Solder Reflow Profile”](#) Application Note.

Tape and Reel Information

Refer to the [“Discrete Devices and IC Switch/Attenuators Tape and Reel Package Orientation”](#) Application Note.

Bill of Material for Evaluation Board

Part	ID	Qty	Size	Value	Units	Manufacturer	Product Number
1	C1, C2, C3, C7	4	1206	10	μF	AVX	TAJA106M006R
2	C4, C5, C6, C8	4	0402	10000	pF	Murata	GRM155R71C103KA01

Evaluation Board Stack-Up

Cross Section		Name	Type	Thick	Material	ε _r
		Pri	Electrical	0.035 mm	Cu	0.0
		Die 1	Isolation	0.4 mm	Rogers 4003	3.38
		L2	Plane	0.035 mm	CU	0.0
		Die 2	Isolation	0.6 mm	FR4	4.0
		L3	Plane	0.035 mm	CU	0.0
		Die 3	Isolation	0.4 mm	FR4	4.0
		Sec	Electrical	0.035 mm	CU	0.0

Branding Specifications

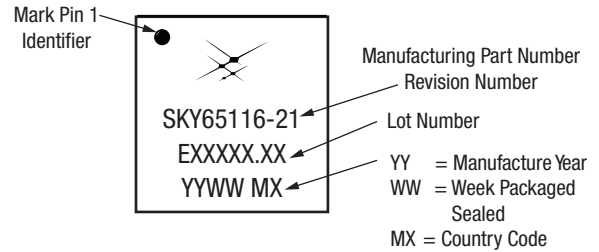

Tape and Reel Dimensions

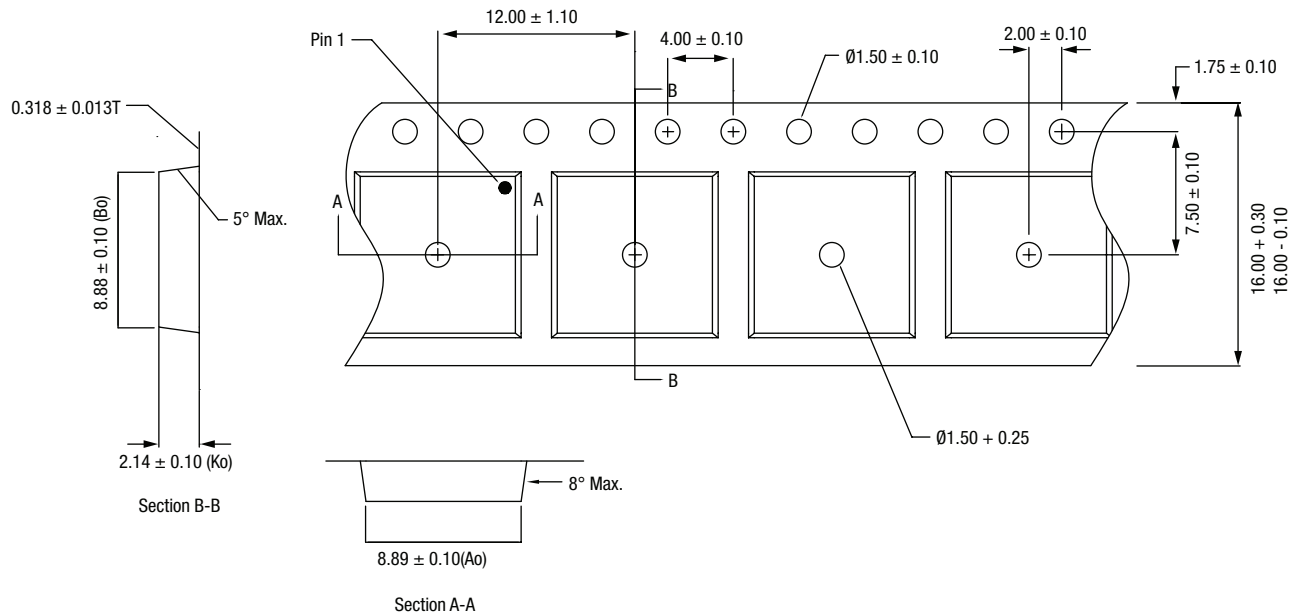

Notes:

- Carrier tapes must meet all requirements of Skyworks GP01-D232 procurement spec for tape and reel shipping.
- Carrier tape shall be black conductive polycarbonate or polystyrene.
- Cover tape shall be transparent conductive pressure sensitive adhesive (PSA) material w/ 13.3 mm width.
- ESD-surface resistivity shall be < / = 1 X 10⁸ ohms/square per EIA, JEDEC TNR specification.
- All dimensions are in millimeter
- Part no.: US039321 (Please indicate on purchase order)

Package Outline and Recommended Footprint

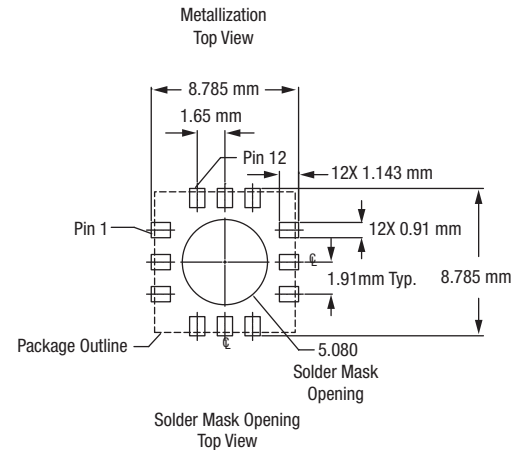
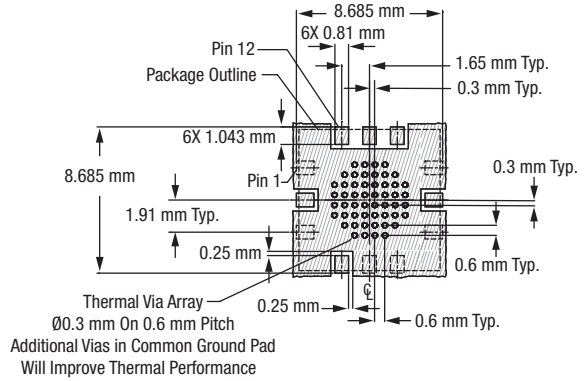
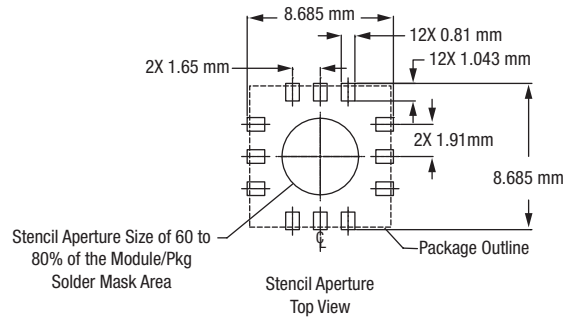
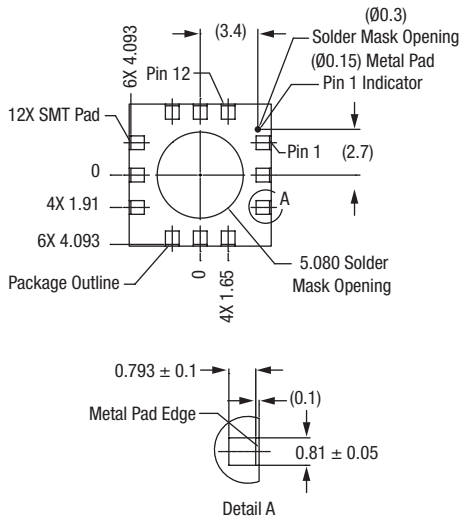
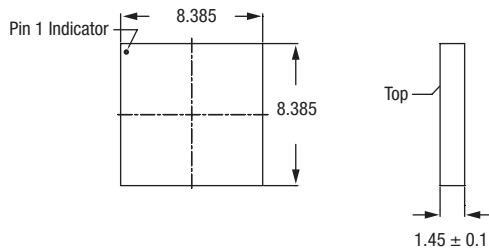

Ordering Information

Model Name	Manufacturing Part Number	Evaluation Kit Part Number
SKY65116: 390–500 MHz linear power amplifier	SKY65116-21 (Pb-free package)	TW14-D621

Copyright © 2008, 2009, Skyworks Solutions, Inc. All Rights Reserved.

Information in this document is provided in connection with Skyworks Solutions, Inc. (“Skyworks”) products or services. These materials, including the information contained herein, are provided by Skyworks as a service to its customers and may be used for informational purposes only by the customer. Skyworks assumes no responsibility for errors or omissions in these materials or the information contained herein. Skyworks may change its documentation, products, services, specifications or product descriptions at any time, without notice. Skyworks makes no commitment to update the materials or information and shall have no responsibility whatsoever for conflicts, incompatibilities, or other difficulties arising from any future changes.

No license, whether express, implied, by estoppel or otherwise, is granted to any intellectual property rights by this document. Skyworks assumes no liability for any materials, products or information provided hereunder, including the sale, distribution, reproduction or use of Skyworks products, information or materials, except as may be provided in Skyworks Terms and Conditions of Sale.

THE MATERIALS, PRODUCTS AND INFORMATION ARE PROVIDED “AS IS” WITHOUT WARRANTY OF ANY KIND, WHETHER EXPRESS, IMPLIED, STATUTORY, OR OTHERWISE, INCLUDING FITNESS FOR A PARTICULAR PURPOSE OR USE, MERCHANTABILITY, PERFORMANCE, QUALITY OR NON-INFRINGEMENT OF ANY INTELLECTUAL PROPERTY RIGHT; ALL SUCH WARRANTIES ARE HEREBY EXPRESSLY DISCLAIMED. SKYWORKS DOES NOT WARRANT THE ACCURACY OR COMPLETENESS OF THE INFORMATION, TEXT, GRAPHICS OR OTHER ITEMS CONTAINED WITHIN THESE MATERIALS. SKYWORKS SHALL NOT BE LIABLE FOR ANY DAMAGES, INCLUDING BUT NOT LIMITED TO ANY SPECIAL, INDIRECT, INCIDENTAL, STATUTORY, OR CONSEQUENTIAL DAMAGES, INCLUDING WITHOUT LIMITATION, LOST REVENUES OR LOST PROFITS THAT MAY RESULT FROM THE USE OF THE MATERIALS OR INFORMATION, WHETHER OR NOT THE RECIPIENT OF MATERIALS HAS BEEN ADVISED OF THE POSSIBILITY OF SUCH DAMAGE.

Skyworks products are not intended for use in medical, lifesaving or life-sustaining applications, or other equipment in which the failure of the Skyworks products could lead to personal injury, death, physical or environmental damage. Skyworks customers using or selling Skyworks products for use in such applications do so at their own risk and agree to fully indemnify Skyworks for any damages resulting from such improper use or sale.

Customers are responsible for their products and applications using Skyworks products, which may deviate from published specifications as a result of design defects, errors, or operation of products outside of published parameters or design specifications. Customers should include design and operating safeguards to minimize these and other risks. Skyworks assumes no liability for applications assistance, customer product design, or damage to any equipment resulting from the use of Skyworks products outside of stated published specifications or parameters.

Skyworks, the Skyworks symbol, and “Breakthrough Simplicity” are trademarks or registered trademarks of Skyworks Solutions, Inc., in the United States and other countries. Third-party brands and names are for identification purposes only, and are the property of their respective owners. Additional information, including relevant terms and conditions, posted at www.skyworksinc.com, are incorporated by reference.