

# DATA SHEET

## **BLF246** VHF power MOS transistor

Product specification  
Supersedes data of September 1992

1996 Oct 21

# VHF power MOS transistor

# BLF246

### FEATURES

- High power gain
- Low noise figure
- Easy power control
- Good thermal stability
- Withstands full load mismatch.

### APPLICATIONS

- Large signal amplifier applications in the VHF frequency range.

### DESCRIPTION

Silicon N-channel enhancement mode vertical D-MOS transistor encapsulated in a 4-lead, SOT121 flange package, with a ceramic cap. All leads are isolated from the flange. A marking code, showing gate-source voltage ( $V_{GS}$ ) information is provided for matched pair applications. Refer to the General section of Data Handbook SC19a for further information.

### PINNING - SOT121

PIN	SYMBOL	DESCRIPTION
1	d	drain
2	s	source
3	g	gate
4	s	source

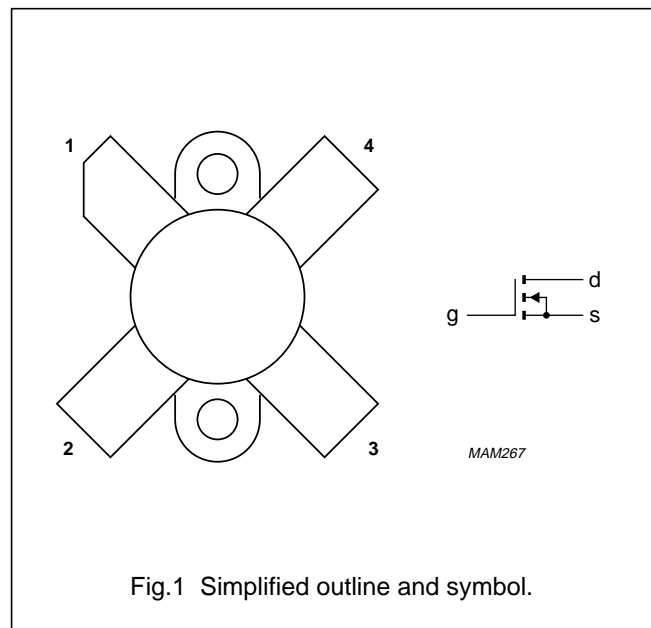

### CAUTION

The device is supplied in an antistatic package.  
The gate-source input must be protected against static discharge during transport or handling.

### QUICK REFERENCE DATA

RF performance at  $T_h = 25\text{ °C}$  in a common source test circuit.

MODE OF OPERATION	f (MHz)	$V_{DS}$ (V)	$P_L$ (W)	$G_p$ (dB)	$\eta_D$ (%)
CW, class-B	108	28	80	$\geq 16$	$\geq 55$

### WARNING

#### Product and environmental safety - toxic materials

This product contains beryllium oxide. The product is entirely safe provided that the BeO disc is not damaged. All persons who handle, use or dispose of this product should be aware of its nature and of the necessary safety precautions. After use, dispose of as chemical or special waste according to the regulations applying at the location of the user. It must never be thrown out with the general or domestic waste.

VHF power MOS transistor

BLF246

**LIMITING VALUES**

In accordance with the Absolute Maximum System (IEC 134).

SYMBOL	PARAMETER	CONDITIONS	MIN.	MAX.	UNIT
$V_{DS}$	drain-source voltage		–	65	V
$V_{GS}$	gate-source voltage		–	$\pm 20$	V
$I_D$	DC drain current		–	13	A
$P_{tot}$	total power dissipation	up to $T_{amb} = 25\text{ }^\circ\text{C}$	–	130	W
$T_{stg}$	storage temperature		–65	150	$^\circ\text{C}$
$T_j$	junction temperature		–	200	$^\circ\text{C}$

**THERMAL CHARACTERISTICS**

SYMBOL	PARAMETER	VALUE	UNIT
$R_{th\ j-mb}$	thermal resistance from junction to mounting base	1.35	K/W
$R_{th\ mb-h}$	thermal resistance from mounting base to heatsink	0.2	K/W

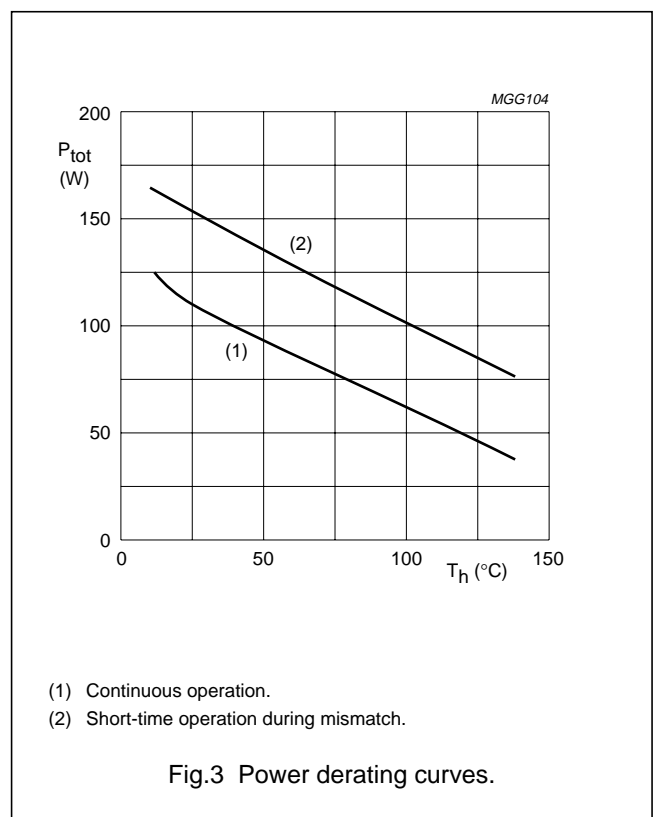
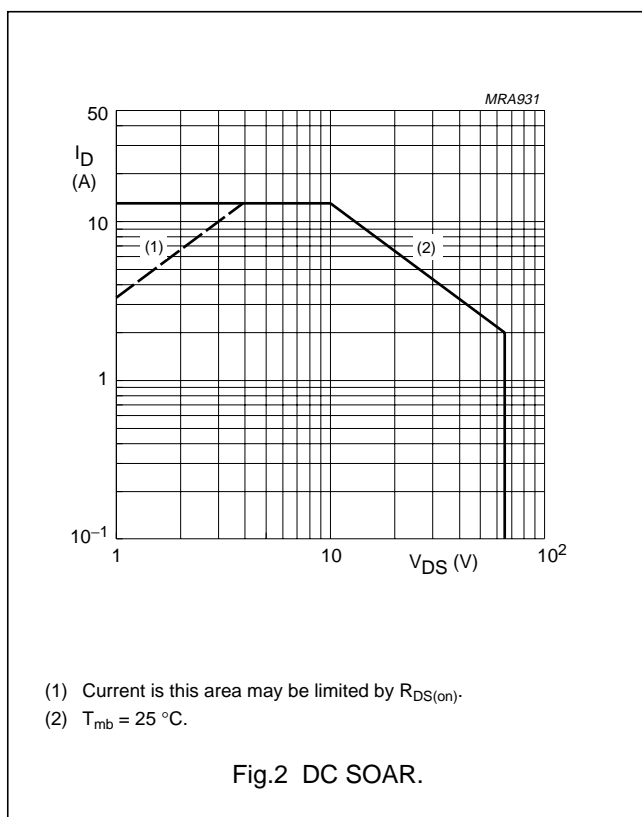

VHF power MOS transistor

BLF246

**CHARACTERISTICS**

$T_j = 25\text{ }^\circ\text{C}$  unless otherwise specified.

SYMBOL	PARAMETER	CONDITIONS	MIN.	TYP.	MAX.	UNIT
$V_{(BR)DSS}$	drain-source breakdown voltage	$V_{GS} = 0; I_D = 50\text{ mA}$	65	–	–	V
$I_{DSS}$	drain-source leakage current	$V_{GS} = 0; V_{DS} = 28\text{ V}$	–	–	2.5	mA
$I_{GSS}$	gate-source leakage current	$V_{GS} = \pm 20\text{ V}; V_{DS} = 0$	–	–	1	$\mu\text{A}$
$V_{GSth}$	gate-source threshold voltage	$I_D = 50\text{ mA}; V_{DS} = 10\text{ V}$	2	–	4.5	V
$\Delta V_{GS}$	gate-source voltage difference of matched pairs	$I_D = 50\text{ mA}; V_{DS} = 10\text{ V}$	–	–	100	mV
$g_{fs}$	forward transconductance	$I_D = 2.5\text{ A or } 5\text{ A}; V_{DS} = 10\text{ V}$	3	4.2	–	S
$R_{DSon}$	drain-source on-state resistance	$I_D = 5\text{ A}; V_{GS} = 10\text{ V}$	–	0.2	0.3	$\Omega$
$I_{DSX}$	on-state drain current	$V_{GS} = 10\text{ V}; V_{DS} = 10\text{ V}$	–	22	–	A
$C_{is}$	input capacitance	$V_{GS} = 0; V_{DS} = 28\text{ V}; f = 1\text{ MHz}$	–	225	–	pF
$C_{os}$	output capacitance	$V_{GS} = 0; V_{DS} = 28\text{ V}; f = 1\text{ MHz}$	–	180	–	pF
$C_{rs}$	feedback capacitance	$V_{GS} = 0; V_{DS} = 28\text{ V}; f = 1\text{ MHz}$	–	25	–	pF

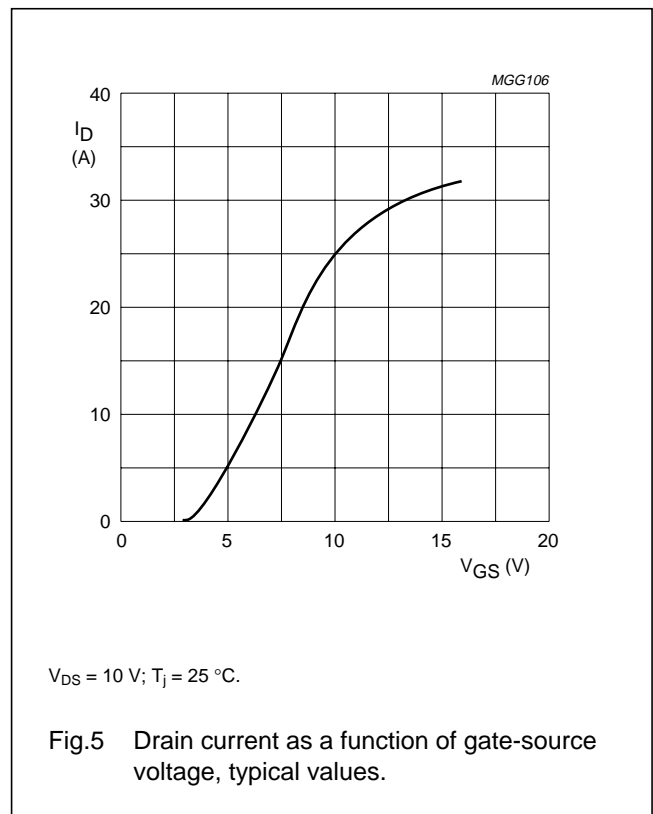
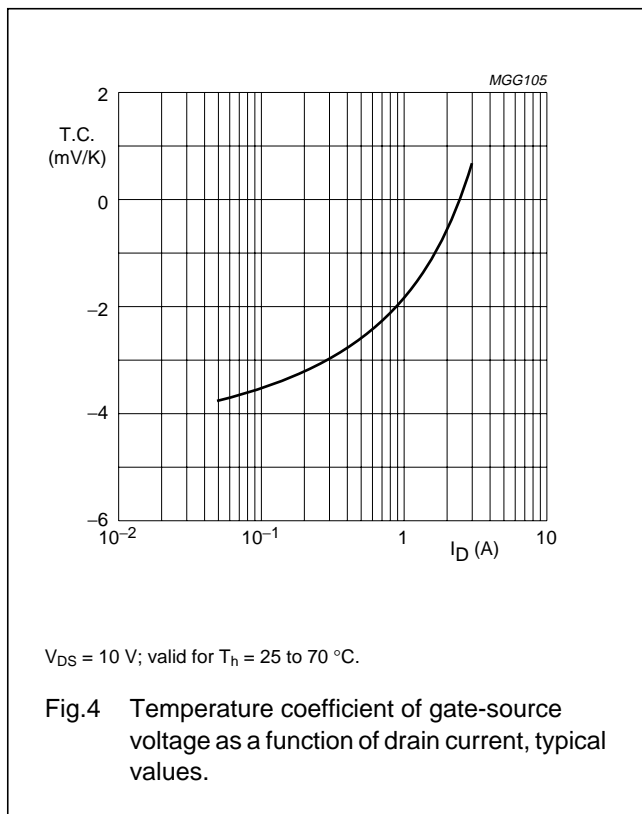

VHF power MOS transistor

BLF246

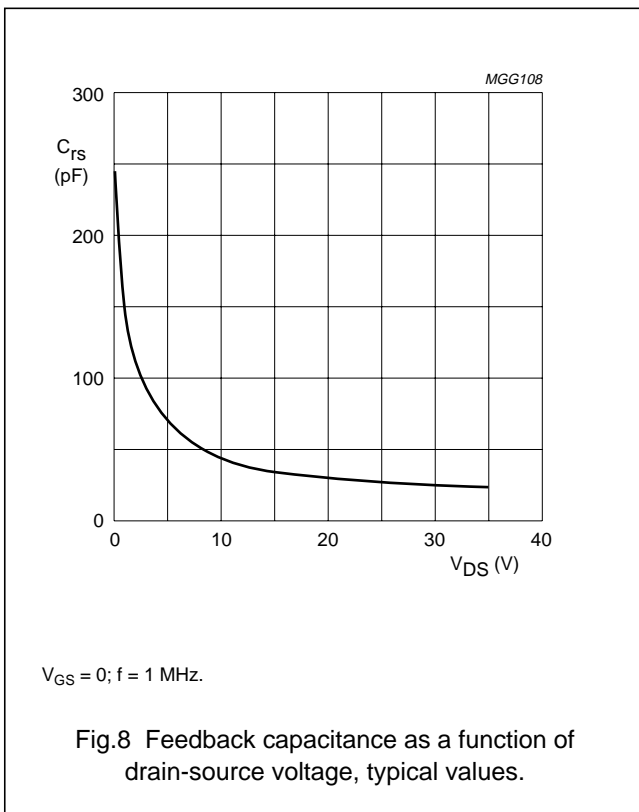
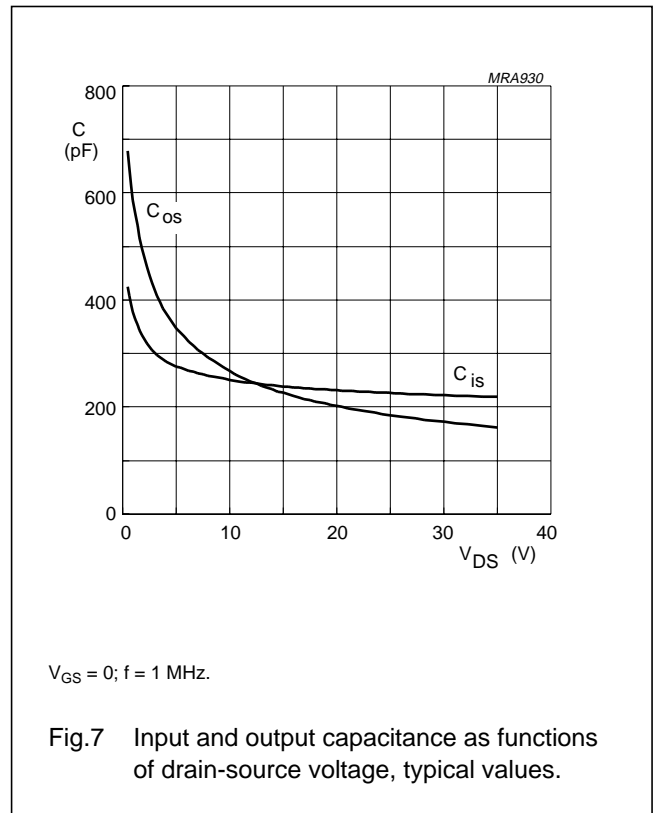
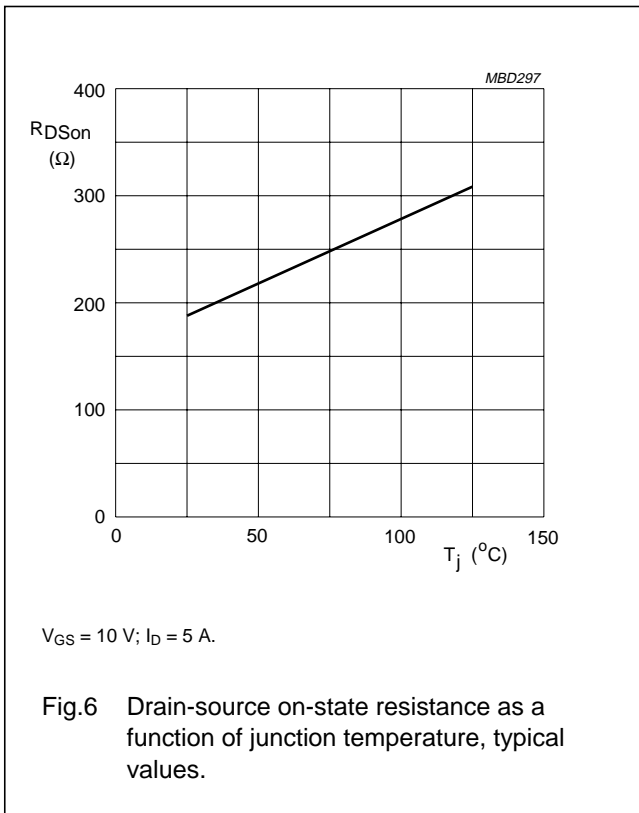

VHF power MOS transistor

BLF246

**APPLICATION INFORMATION**

RF performance in CW operation in a common source test circuit.

$T_h = 25\text{ }^\circ\text{C}$ ;  $R_{th\text{ mb-h}} = 0.2\text{ K/W}$ ;  $R_{GS} = 12\text{ }\Omega$  unless otherwise specified.

MODE OF OPERATION	f (MHz)	V <sub>DS</sub> (V)	I <sub>D</sub> (A)	P <sub>L</sub> (W)	G <sub>p</sub> (dB)	$\eta_D$ (%)
CW, class-B	108	28	0.1	80	>16	>55
CW, class-B	108	28	0.1	80	typ. 18	typ. 65
CW, class-C	108	28	0 <sup>(1)</sup>	80	typ. 15	typ. 72

**Note**

- $V_{GS} = 0$  (class-C).

**Ruggedness in class-B operation**

The BLF246 is capable of withstanding a load mismatch corresponding to VSWR = 50: 1 through all phases under the following conditions:  $V_{DS} = 28\text{ V}$ ;  $f = 108\text{ MHz}$ ;  $T_h = 25\text{ }^\circ\text{C}$ ;  $R_{th\text{ mb-h}} = 0.2\text{ K/W}$  at rated output power.

**Noise figure**

Measured with 80 W power-matched source and load in the test circuit (see Fig.9) with  $V_{DS} = 28\text{ V}$ ;  $I_D = 2\text{ A}$ ;  $f = 108\text{ MHz}$ ;  $R_{GS} = 27\text{ }\Omega$ ;  $T_h = 25\text{ }^\circ\text{C}$ ;  $R_{th\text{ mb-h}} = 0.2\text{ K/W}$ ;  $F = \text{typ. } 3\text{ dB}$ .

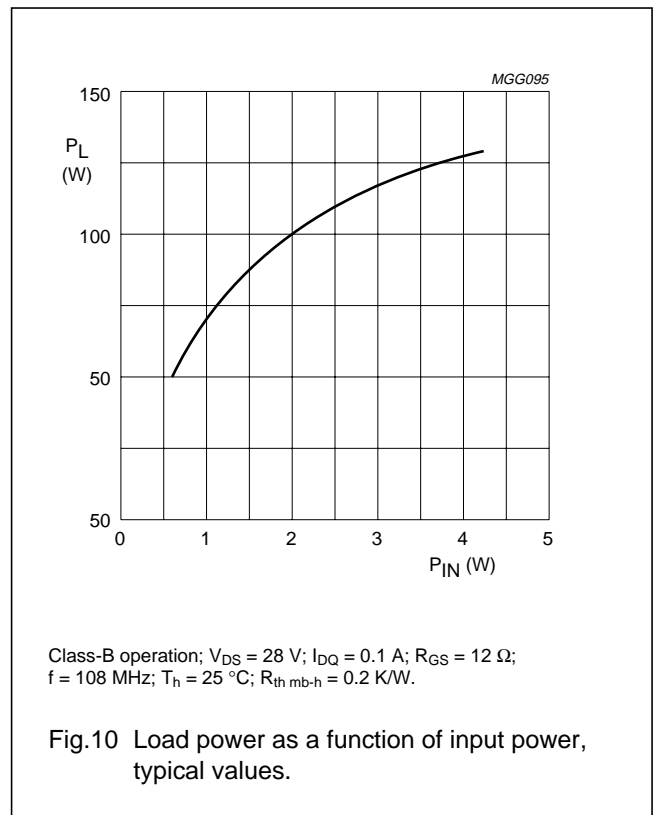
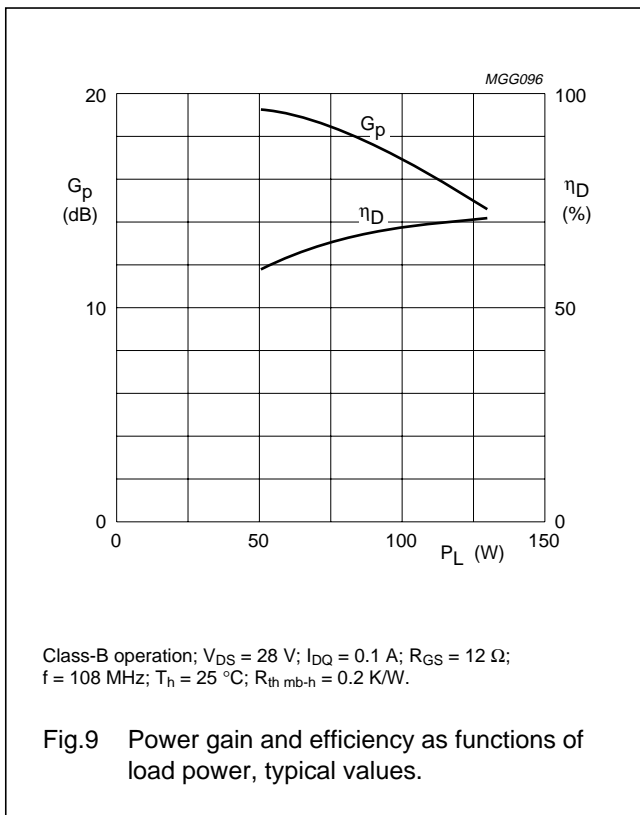

VHF power MOS transistor

BLF246

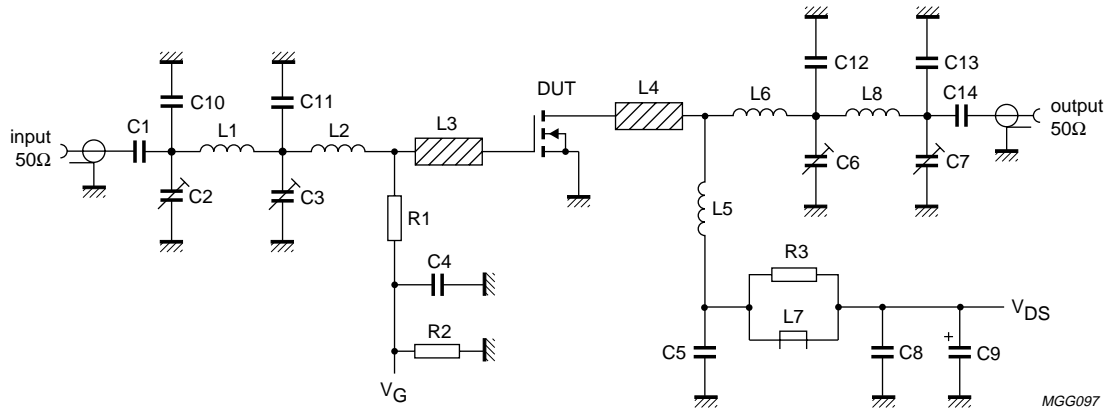

Fig.11 Test circuit for class-B operation at 108 MHz.

## VHF power MOS transistor

BLF246

List of components (see Figs 11 and 12).

COMPONENT	DESCRIPTION	VALUE	DIMENSIONS	CATALOGUE NO.
C1, C4, C5, C8, C14	multilayer ceramic chip capacitor	100 nF		2222 852 47104
C2, C3, C6, C7	film dielectric trimmer	5 to 60 pF		2222 809 08003
C9	electrolytic capacitor	2.2 $\mu$ F, 63 V		2222 030 38228
C10	multilayer ceramic chip capacitor; note 1	68 pF + 39 pF in parallel		
C11	multilayer ceramic chip capacitor; note 1	69 pF + 100 pF in parallel		
C12	multilayer ceramic chip capacitor; note 1	2x 100 pF in parallel		
C13	multilayer ceramic chip capacitor; note 1	62 pF		
L1	5 turns enamelled 0.6 mm copper wire	52 nH	length 6.5 mm int. dia. 3 mm leads 2 $\times$ 10 mm	
L2	2 turns enamelled 0.6 mm copper wire	19 nH	length 3.5 mm int. dia. 3 mm leads 2 $\times$ 7.5 mm	
L3, L4	stripline; note 2	31 $\Omega$	length 13 mm width 6 mm	
L5	3 turns enamelled 1.6 mm copper wire	36 nH	length 12 mm int. dia. 6 mm leads 2 $\times$ 5 mm	
L6	hairpin of enamelled 1.6 mm copper wire	14 nH	length 20 mm	
L7	grade 3B Ferroxcube HF choke			4312 020 36640
L8	3 turns enamelled 1.6 mm copper wire	52 nH	length 8 mm int. dia. 6 mm leads 2 $\times$ 9 mm	
R1	metal film resistor	2 $\times$ 24 $\Omega$ in parallel, 0.4 W		
R2	metal film resistor	100 k $\Omega$ , 0.4 W		
R3	metal film resistor	10 $\Omega$ , 0.4 W		

## Notes

- American Technical Ceramics capacitor, type 100B or other capacitor of the same quality.
- The striplines are mounted on a double copper-clad PCB with epoxy fibre-glass dielectric ( $\epsilon_r = 4.5$ ), thickness 1.6 mm.



VHF power MOS transistor

BLF246

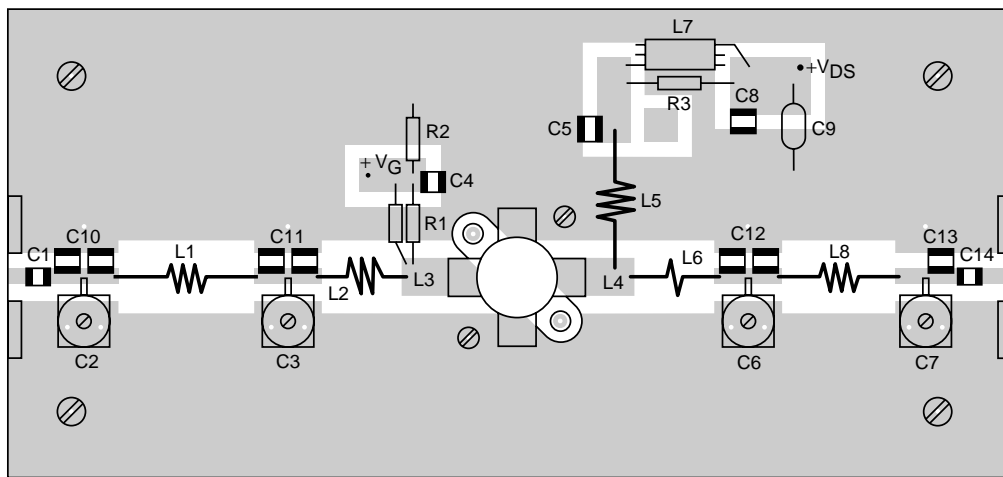
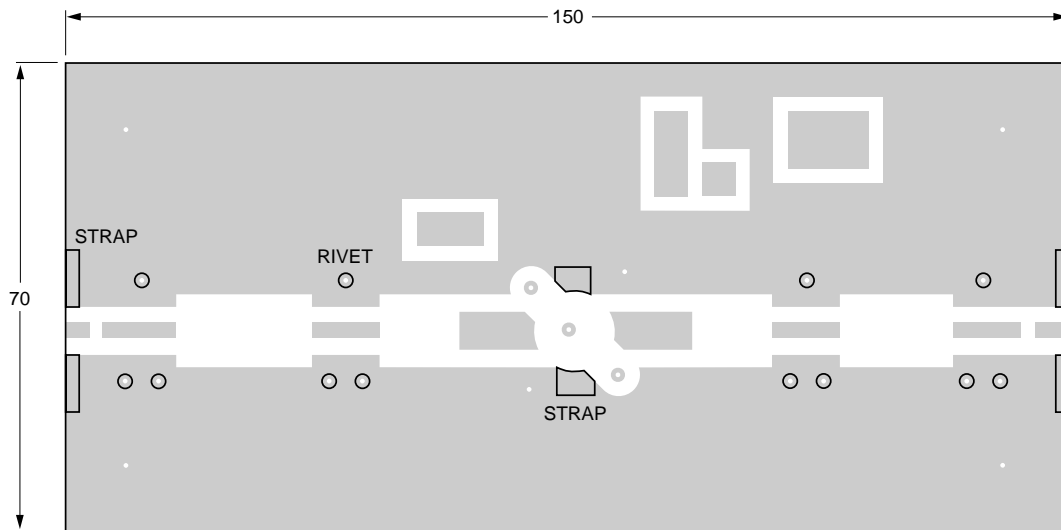

MGG098

Dimensions in mm.

The circuit and components are situated on one side of the epoxy fibre-glass board, the other side being fully metallized to serve as a ground. Earth connections are made by means of hollow rivets, whilst under the source leads, copper straps are used for a direct contact between the upper and lower sheets.

Fig.12 Component layout for 108 MHz class-B test circuit.

VHF power MOS transistor

BLF246

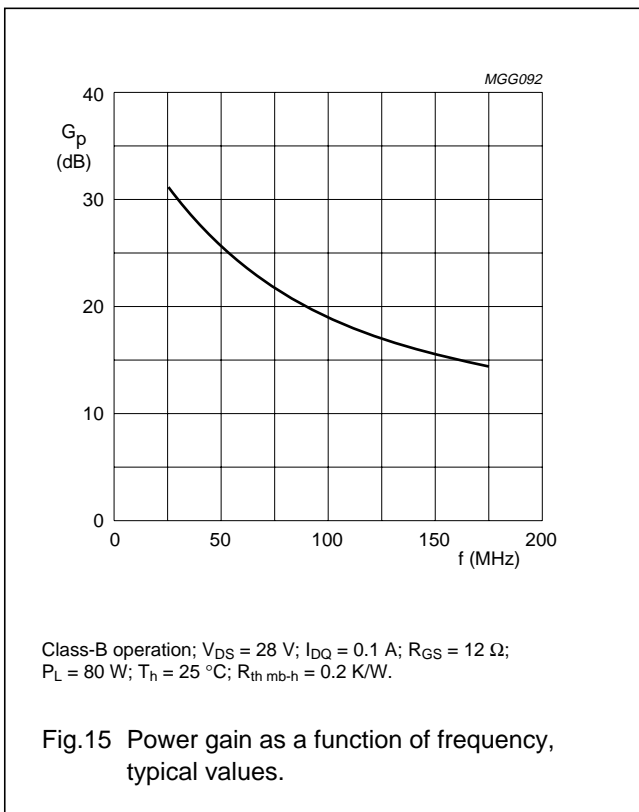
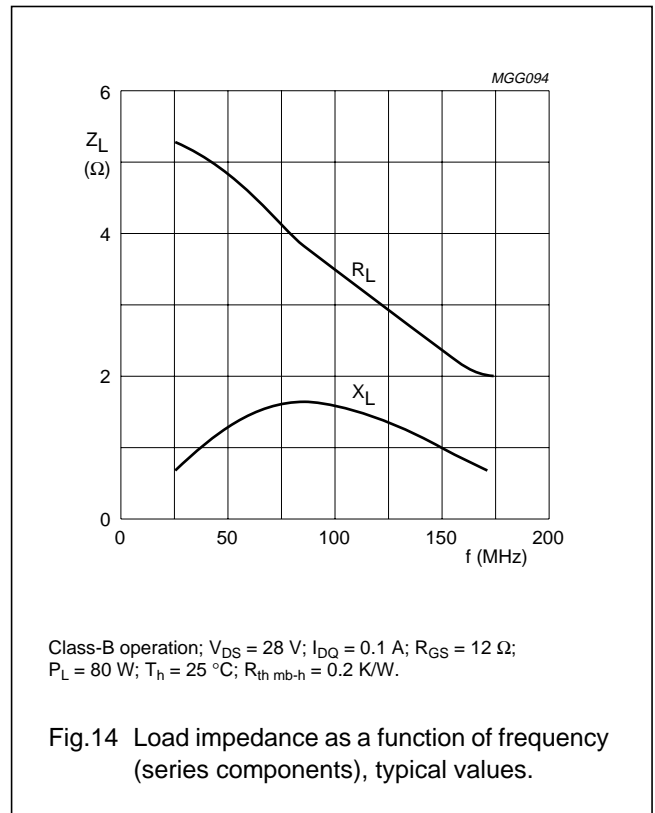
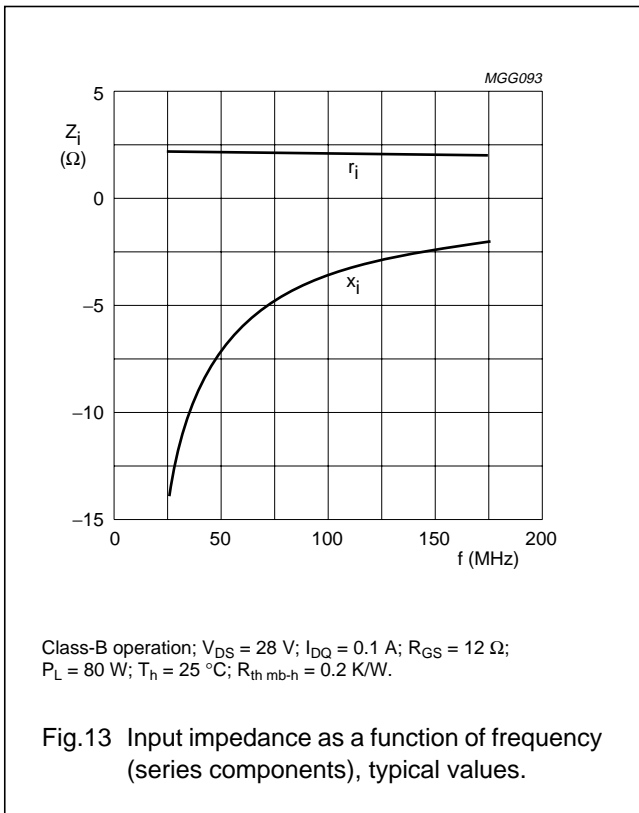

VHF power MOS transistor

BLF246

PACKAGE OUTLINE

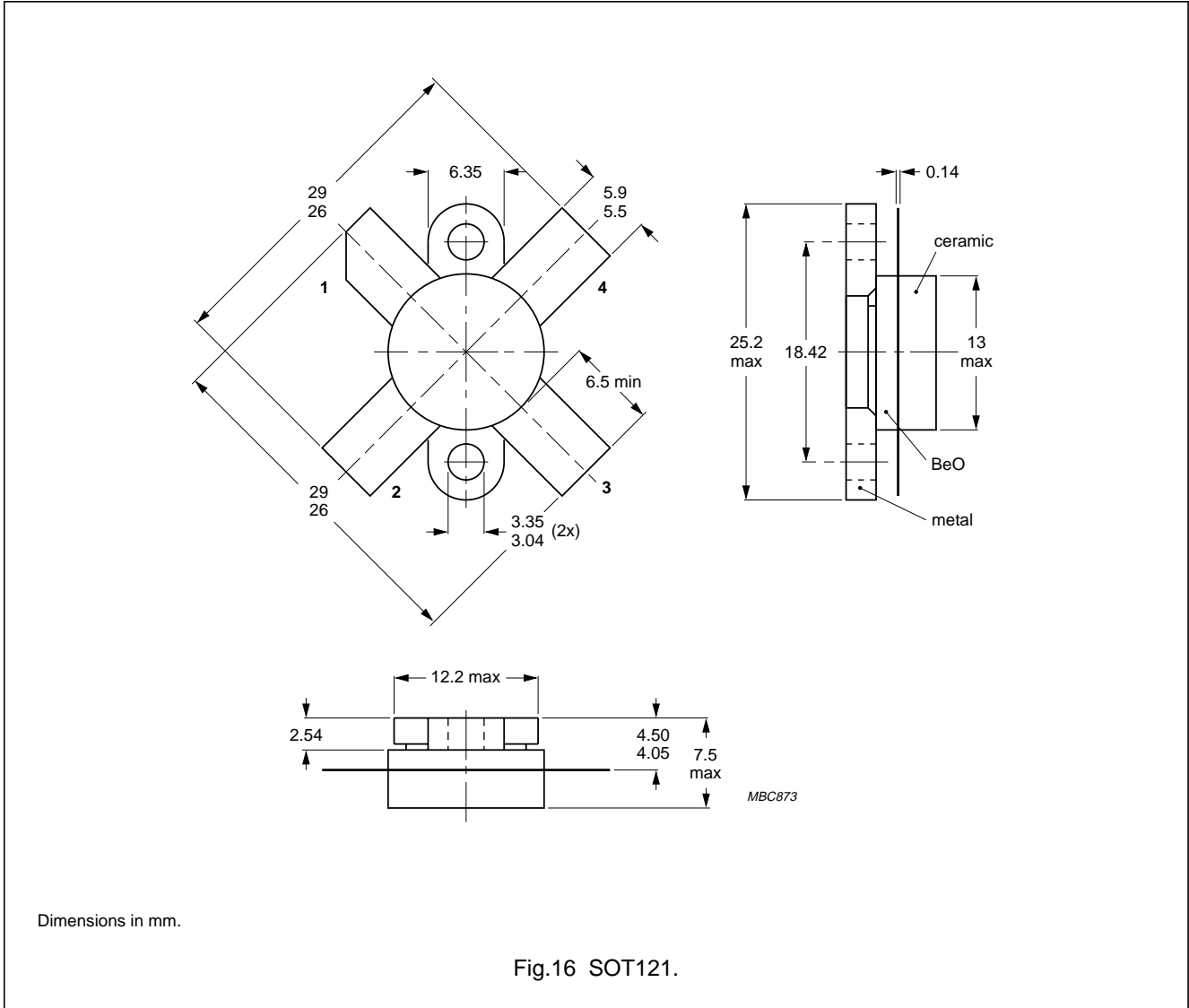

## VHF power MOS transistor

BLF246

**DEFINITIONS**

<b>Data Sheet Status</b>	
Objective specification	This data sheet contains target or goal specifications for product development.
Preliminary specification	This data sheet contains preliminary data; supplementary data may be published later.
Product specification	This data sheet contains final product specifications.
<b>Limiting values</b>	
Limiting values given are in accordance with the Absolute Maximum Rating System (IEC 134). Stress above one or more of the limiting values may cause permanent damage to the device. These are stress ratings only and operation of the device at these or at any other conditions above those given in the Characteristics sections of the specification is not implied. Exposure to limiting values for extended periods may affect device reliability.	
<b>Application information</b>	
Where application information is given, it is advisory and does not form part of the specification.	

**LIFE SUPPORT APPLICATIONS**

These products are not designed for use in life support appliances, devices, or systems where malfunction of these products can reasonably be expected to result in personal injury. Philips customers using or selling these products for use in such applications do so at their own risk and agree to fully indemnify Philips for any damages resulting from such improper use or sale.