

SSD2531

Product Preview

21 Driving x 12 Sensing Capacitive Touch Panel Controller

This document contains information on a product under development. Solomon Systech reserves the right to change or discontinue this product without notice.

<http://www.solomon-systech.com>

SSD2531

Rev 0.20 | P 1/58 | Apr 2010

Copyright © 2010 Solomon Systech Limited



Appendix: IC Revision history of SSD2531 Specification

Version	Change Items	Effective Date
0.10	1 st Release	29-Mar-10
0.20	Updated Ch.4 Block diagram on P.8 Updated Ch. 6 Pin description on P.13, 14 Updated Ch.8 Commend Table on P.16	14-Apr-10

Confidential

CONTENTS

1	GENERAL DESCRIPTION	7
2	FEATURES.....	7
3	ORDERING INFORMATION	7
4	BLOCK DIAGRAM	8
5	PIN ARRANGEMENT.....	9
5.1.1	68 pin QFN	9
5.1.2	48 pin QFN	10
5.1.3	40 pin QFN	11
5.1.4	Die pad coordinate (TBD)	12
6	PIN DESCRIPTIONS.....	13
6.1	POWER.....	13
6.2	LOGIC.....	13
6.3	ANALOG.....	14
6.4	OUTPUT.....	14
7	FUNCTIONAL BLOCK DESCRIPTIONS.....	15
7.1	STYPE0, STYPE1	15
7.2	TIMING AND CONTROL LOGIC	15
7.3	DSP.....	15
7.4	ADC.....	15
7.5	NOISE REJECTION CORRELATOR	15
7.6	ANALOG MULTIPLEXER.....	15
7.7	ANALOG BOOSTER CIRCUIT	15
7.8	IIC INTERFACE.....	15
7.9	12 PINS SENSING INPUT	15
7.10	21 PINS DRIVING OUTPUT AMPLIFIER	15
7.11	4 PINS SELF-CAP INPUT	15
8	COMMAND TABLE	16
9	COMMAND DESCRIPTIONS.....	23
10	REGISTERS.....	43
11	MAXIMUM RATINGS.....	44
12	DC CHARACTERISTICS.....	44
13	AC CHARACTERISTICS.....	45
14	POWER UP/DOWN SEQUENCE	47
14.1	POWER UP / DOWN FLOW CHART	47
14.2	POWER UP.....	48
14.3	POWER DOWN	49
15	APPLICATION EXAMPLES	50
15.1	APPLICATION DIAGRAM	50
15.2	PANEL DESIGN REFERENCE	51

15.3	FPC DESIGN REFERENCE.....	52
16	PACKAGE INFORMATION.....	53
16.1	QFN 68 PINS (8X8MM).....	53
16.2	QFN 48 PINS (6X6MM).....	54
16.3	QFN 40 PINS (5X5MM).....	55
16.4	PACKAGE ORIENTATION	56

Confidential

TABLES

TABLE 3-1: ORDERING INFORMATION	7
TABLE 5-1: 68 PIN QFN PIN ASSIGNMENT TABLE	9
TABLE 5-2: 48 PIN QFN PIN ASSIGNMENT TABLE	10
TABLE 5-3: 40 PIN QFN PIN ASSIGNMENT TABLE	11
TABLE 8-1: COMMAND TABLE	16
TABLE 11-1: MAXIMUM RATINGS (VOLTAGE REFERENCED TO V_{SS}).....	44
TABLE 13-1 :I ² C INTERFACE TIMING CHARACTERISTICS.....	45
TABLE 13-2 : SERIAL TIMING CHARACTERISTICS (TA = -40 to 85 ° C, VDDIO = 2.7V, VSS =0V).....	46
TABLE 15-1 : TOUCH PANEL CHARACTERISTICS	51

Confidential

FIGURES

FIGURE 4-1: SSD2531 BLOCK DIAGRAM	8
FIGURE 5-1: PINOUT DIAGRAM –68 PIN QFN (TOPVIEW)	9
FIGURE 5-2: PINOUT DIAGRAM –48 PIN QFN (TOPVIEW)	10
FIGURE 5-3: PINOUT DIAGRAM –40 PIN QFN (TOPVIEW)	11
FIGURE 13-1 : I ² C INTERFACE TIMING CHARACTERISTICS	45
FIGURE 13-2 : SERIAL TIMING CHARACTERISTICS	46
FIGURE 15-1: APPLICATION EXAMPLE.....	50
FIGURE 16-1 : SSD2531QN4 PACKAGE ORIENTATION	56
FIGURE 16-2 : SSD2531QN5 PACKAGE ORIENTATION	56
FIGURE 16-3 : SSD2531QN6 PACKAGE ORIENTATION	57

Confidential

1 GENERAL DESCRIPTION

SSD2531 is an all in one capacitive touch panel driver that integrated the power circuits, driving and sensing circuits into a single chip. It can drive capacitive type touch panel with up to 21 driving and 12 sensing lines.

2 FEATURES

- Operating voltage:
 - VCI: 2.5 ~ 3.3V
 - VDDIO: 1.65 ~ 3.3V
- 8V to 15.5V(max.) driving voltage with external booster Caps
- 16 steps in 0.5V increment programmable driving voltage control
- Support 640x352 touch resolution and capable to support up to WVGA panel
- Support 200Hz max. sampling rate (25 ~200Hz user programmable)
- Total 21 driving and 12 sensing pins
- Fully programmable driver scanning order
- 8 choices for Touch Screen Orientation control
- Provide (X,Y) coordinates and number of touch points with force index and speed index (Max 4 points)
- 4 individual capacitance sensing button pins
- Automatic mode switching (Normal, Idle)
- Auto calibration for each cross-over point
- Support IIC (up to 400kbit/s) and 4-wires SPI interface
- Package: QFN 68 pins, QFN48, QFN40, COG

3 ORDERING INFORMATION

Table 3-1: Ordering Information

Ordering Part Number	Drive	Sense	Package Form	Reference	Remark
SSD2531QN4	21	12	QFN68		IIC, SPI
SSD2531QN5	16	12	QFN48		IIC only
SSD2531QN6	12	8	QFN40		IIC only
SSD2531Z	21	12	COG		IIC, SPI

4 BLOCK DIAGRAM

Figure 4-1: SSD2531 Block Diagram

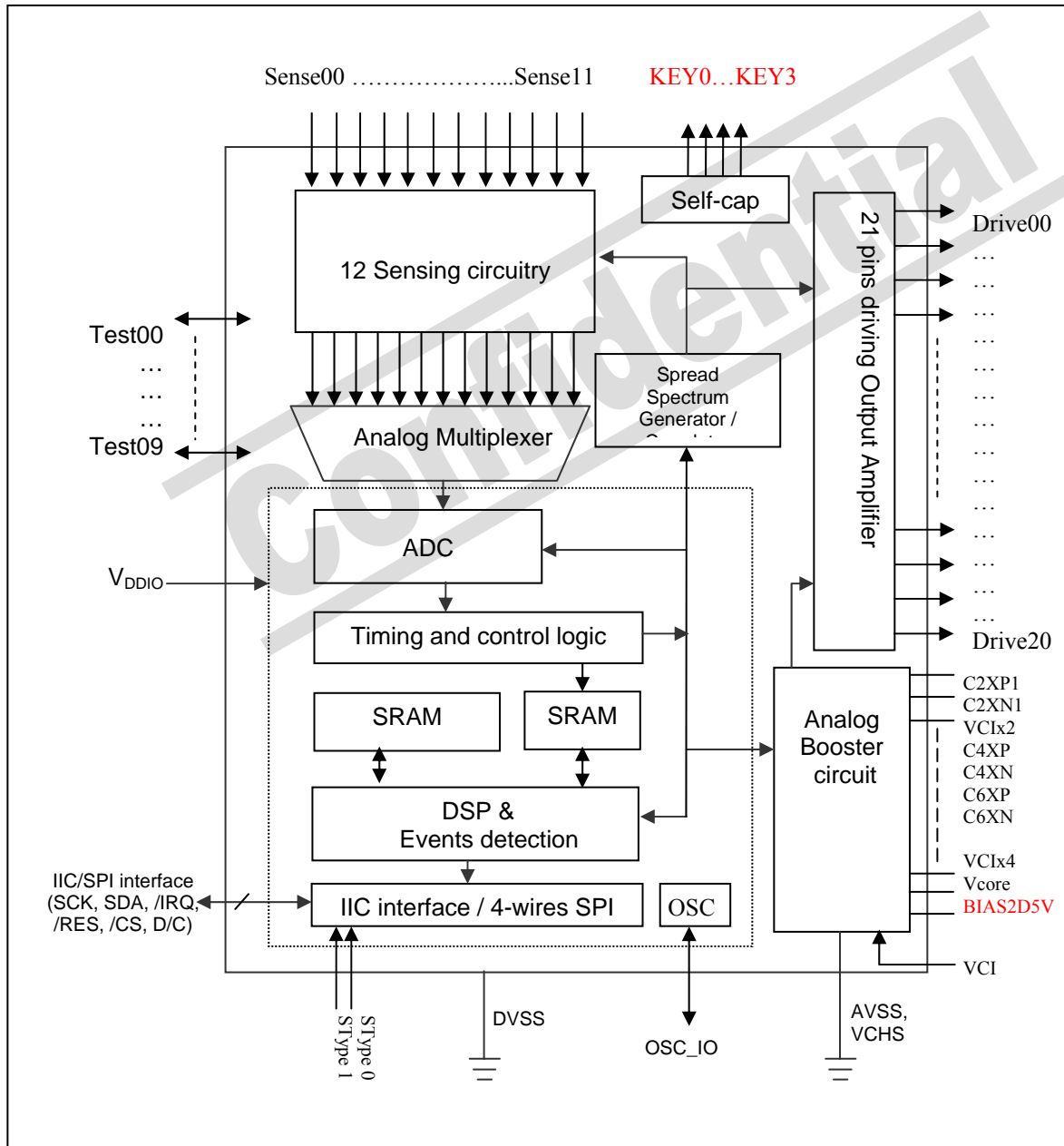

5 PIN ARRANGEMENT

5.1.1 68 pin QFN

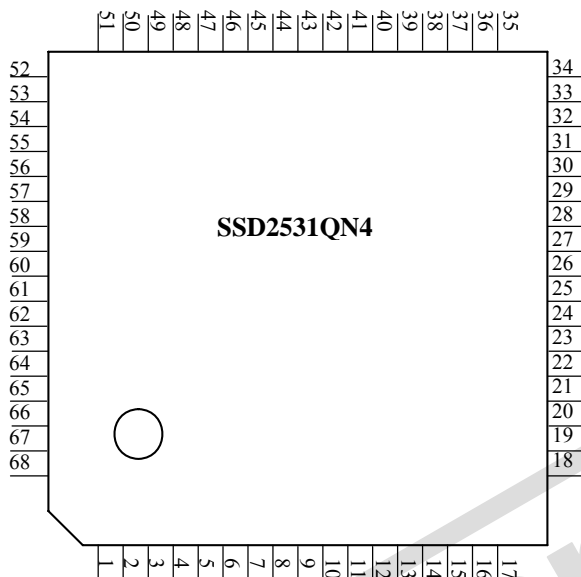

Figure 5-1: Pinout Diagram –68 pin QFN (Topview)

Pin #	Signal Name	Pin #	Signal Name	Pin #	Signal Name	Pin #	Signal Name
1	/IRQ	18	C4XN	35	NC	52	DRIVE20
2	KEY0	19	C4XP	36	AVSS	53	DRIVE19
3	KEY1	20	C6XP	37	SENSE00	54	DRIVE18
4	KEY2	21	C6XN	38	SENSE01	55	DRIVE17
5	KEY3	22	VCIX4	39	SENSE02	56	DRIVE16
6	Stype0	23	VCHS	40	SENSE03	57	DRIVE15
7	Stype1	24	DRIVE00	41	SENSE04	58	DRIVE14
8	DVSS	25	DRIVE01	42	SENSE05	59	DRIVE13
9	VCORE	26	DRIVE02	43	SENSE06	60	DRIVE12
10	VDDIO	27	DRIVE03	44	SENSE07	61	DRIVE11
11	VCI	28	DRIVE04	45	SENSE08	62	DRIVE10
12	BIAS2D5V	29	DRIVE05	46	SENSE09	63	/CS
13	AVSS	30	DRIVE06	47	SENSE10	64	D/C
14	VCIX2	31	DRIVE07	48	SENSE11	65	/RESET
15	C2XP1	32	DRIVE08	49	AVSS	66	SDA
16	C2XN1	33	DRIVE09	50	NC	67	SCK
17	NC	34	NC	51	NC	68	NC

Table 5-1: 68 pin QFN Pin Assignment Table

5.1.2 48 pin QFN

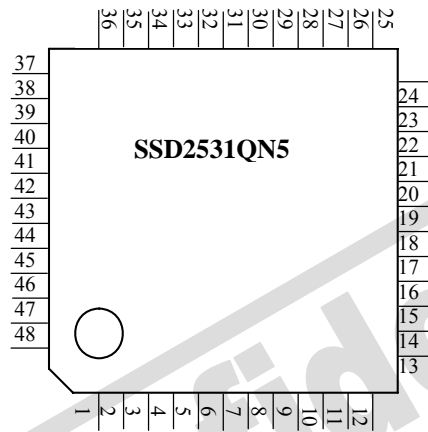

Figure 5-2: Pinout Diagram –48 pin QFN (Topview)

Pin #	Signal Name	Pin #	Signal Name	Pin #	Signal Name	Pin #	Signal Name
1	SCK	13	C4XP	25	AVSS	37	SENSE11
2	/IRQ	14	C6XP	26	SENSE00	38	DRIVE18
3	DVSS	15	C6XN	27	SENSE01	39	DRIVE17
4	VCORE	16	VCIX4	28	SENSE02	40	DRIVE16
5	VDDIO	17	VCHS	29	SENSE03	41	DRIVE15
6	VCI	18	DRIVE03	30	SENSE04	42	DRIVE14
7	BIAS2D5V	19	DRIVE04	31	SENSE05	43	DRIVE13
8	AVSS	20	DRIVE05	32	SENSE06	44	DRIVE12
9	VCIX2	21	DRIVE06	33	SENSE07	45	DRIVE11
10	C2XP1	22	DRIVE07	34	SENSE08	46	DRIVE10
11	C2XN1	23	DRIVE08	35	SENSE09	47	/RESET
12	C4XN	24	DRIVE09	36	SENSE10	48	SDA

Table 5-2: 48 pin QFN Pin Assignment Table

5.1.3 40 pin QFN

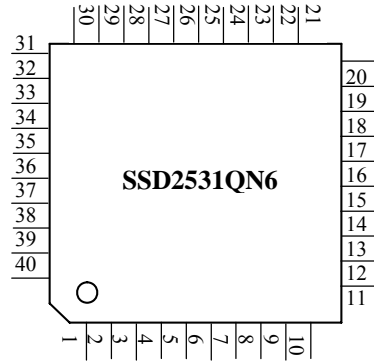

Figure 5-3: Pinout Diagram –40 pin QFN (Topview)

Pin #	Signal Name	Pin #	Signal Name	Pin #	Signal Name	Pin #	Signal Name
1	IRQ_N	11	C4XN	21	DRIVE09	31	DRIVE16
2	Stype	12	C4XP	22	AVSS	32	DRIVE15
3	DVSS	13	C6XP	23	SENSE00	33	DRIVE14
4	VCORE	14	C6XN	24	SENSE01	34	DRIVE13
5	VCI	15	VCIX4	25	SENSE02	35	DRIVE12
6	BIAS2D5V	16	VCHS	26	SENSE03	36	DRIVE11
7	AVSS	17	DRIVE05	27	SENSE04	37	DRIVE10
8	VCIX2	18	DRIVE06	28	SENSE05	38	/RESET
9	C2XP1	19	DRIVE07	29	SENSE06	39	SDA
10	C2XN1	20	DRIVE08	30	SENSE07	40	SCK

Table 5-3: 40 pin QFN Pin Assignment Table

5.1.4 Die pad coordinate (TBD)

Confidential

6 PIN DESCRIPTIONS

Key:

I = Input
 O =Output
 IO = Bi-directional (input/output)
 P = Power pin
 Hi-Z = High impedance

6.1 Power

Pin Name	Type	QFN68	QFN48	QFN40	RESET# State	Description
V _{DDIO}	P				N/A	This pin is power supply input for I/O buffer
V _{CI}	P				N/A	This pin is power supply input for analog circuit
V _{CHS}	P				N/A	This pin is ground for Booster and HV switches
DV _{SS}	P				N/A	This pin is ground for logic
AV _{SS}	P				N/A	This pin is ground for analog

6.2 Logic

Pin Name	Type	QFN68	QFN48	QFN40	RESET# State	Description
/Reset	I				V _{DDIO}	This is Reset pin for the chip
/IRQ	O				V _{DDIO}	This is Interrupt pin for Interrupt request
SDA	IO				Hi-Z	IIC data pin
SCK	I				Hi-Z	IIC clock input pin
Stype1, Stype0	I				Hi-Z	Bus interface mode selection pin. 00: IIC address = 0x5C 01: Reserve 10: IIC address = 0x48 11: SPI
OSC_IO	IO				Hi-Z	Input/Output of internal oscillator
MFR	I				V _{DDIO}	Factory test pin. Connect to V _{DDIO} for Normal Operation. Connect to GND for Factory Test Mode
MF_Data0	O				V _{DDIO}	Frame scan sync. signal output. Active only in Factory Test Mode
MF_Data1	O				V _{DDIO}	Frame scanning data output. Active only in Factory Test Mode

6.3 Analog

Pin Name	Type	QFN68	QFN48	QFN40	RESET# State	Description
C2XP1	IO				V_{CI}/V_{CHS}	Booster pin. Connect a capacitor to C2XN1
C2XN1	IO				V_{CI}/V_{CHS}	Booster pin. Connect a capacitor to C2XP1
C4XP	IO				V_{CI}/V_{CHS}	Booster pin. Connect a capacitor to C4XN
C4XN	IO				V_{CI}/V_{CHS}	Booster pin. Connect a capacitor to C4XP
C6XP	IO				V_{CI}/V_{CHS}	Booster pin. Connect a capacitor to C6XN
C6XN	IO				V_{CI}/V_{CHS}	Booster pin. Connect a capacitor to C6XP
V_{CIX2}	P				V_{CI}/V_{CHS}	Output power supply for 2x booster. Connect a capacitor for stabilization
V_{CIX4}	P				V_{CI}/V_{CHS}	Output power supply for 4x/6x booster. Connect a capacitor for stabilization
BIAS2D5V	P				V_{CI}/V_{CHS}	Regulated voltage supply for sensor circuit. Connect a capacitor for stabilization
Vcore	P				N/A	Regulated voltage supply for logic circuit. Connect a capacitor for stabilization

6.4 Output

Pin Name	Type	QFN68	QFN48	QFN40	RESET# State	Description
Sense00 - Sense11	I				Hi-Z	Sensor input pins
Drive00 - Drive20	O				V_{CHS}	Driver output pins
KEY0-KEY3	I				Hi-Z	Self-cap input pins

7 FUNCTIONAL BLOCK DESCRIPTIONS

7.1 STYPE0, STYPE1

In SSD2531, there are 2 addresses for IIC interface. (i.e. 48h, 5Ch)

7.2 Timing and control logic

This block controls the scanning frequency in different mode and setting.

7.3 DSP

This block is the digital signal processing unit. It converts the raw data to the point's coordinates and events.

7.4 ADC

This block is an analog to digital converter for converting the sensing signal to digital data storing into SRAM.

7.5 Noise rejection Correlator

This block is used to filtering the noise from background.

7.6 Analog Multiplexer

This block is multiplex the Sense signal to ADC.

7.7 Analog Booster circuit

This block generates the high output driving voltage for the driving pins.

7.8 IIC interface

This block is used to communicate with the MCU.
SSD2531 supports the IIC interface with a bit rate up to 400 kbits/s.
It supports only the mandatory slave feature showed below.

- START Condition
- STOP Condition
- Acknowledge
- 7-bit slave address

7.9 12 pins Sensing input

This block is the sensing circuit.

7.10 21 pins driving Output Amplifier

This block is the driving output circuit.

7.11 4 pins Self-cap input

This block is the self cap circuit.

8 COMMAND TABLE

Table 8-1: Command Table

Reg#	Function	R/W/C	No. of Byte	Parameter	Default
R00h	No Operation	C	0	N/A	N/A
R01h	Software Reset	C	0	N/A	N/A
R02h	Device ID	R	2	nibble based representation of "2531"	0x2531
R06h	Number of Driving Electrodes	W	1	[7:4]: Reserved [3:0]: Select between 6 to 21 electrodes according to mapping in specification.	0x1F
R07h	Number of Sensing Electrodes	W	1	[7:3]: Reserved [2:0]: Select between 6 to 12 electrodes according to mapping in specification.	0x06
R08h	Select Drive Pin and Slew Rate for Drive Line 00	W	1	[7:5] Slew rate [4:0] Drive pin select	0x00
R09h	Select Drive Pin and Slew Rate for Drive Line 01	W	1	[7:5] Slew rate [4:0] Drive pin select	0x01
RAh	Select Drive Pin and Slew Rate for Drive Line 02	W	1	[7:5] Slew rate [4:0] Drive pin select	0x02
RBh	Select Drive Pin and Slew Rate for Drive Line 03	W	1	[7:5] Slew rate [4:0] Drive pin select	0x03
RCh	Select Drive Pin and Slew Rate for Drive Line 04	W	1	[7:5] Slew rate [4:0] Drive pin select	0x04
RDh	Select Drive Pin and Slew Rate for Drive Line 05	W	1	[7:5] Slew rate [4:0] Drive pin select	0x05
REh	Select Drive Pin and Slew Rate for Drive Line 06	W	1	[7:5] Slew rate [4:0] Drive pin select	0x06
RFh	Select Drive Pin and Slew Rate for Drive Line 07	W	1	[7:5] Slew rate [4:0] Drive pin select	0x07
R10h	Select Drive Pin and Slew Rate for Drive Line 08	W	1	[7:5] Slew rate [4:0] Drive pin select	0x08
R11h	Select Drive Pin and Slew Rate for Drive Line 09	W	1	[7:5] Slew rate [4:0] Drive pin select	0x09
R12h	Select Drive Pin and Slew Rate for Drive Line 10	W	1	[7:5] Slew rate [4:0] Drive pin select	0x0A
R13h	Select Drive Pin and Slew Rate for Drive Line 11	W	1	[7:5] Slew rate [4:0] Drive pin select	0x0B
R14h	Select Drive Pin and Slew Rate for Drive Line 12	W	1	[7:5] Slew rate [4:0] Drive pin select	0x0C
R15h	Select Drive Pin and Slew Rate for Drive Line 13	W	1	[7:5] Slew rate [4:0] Drive pin select	0x0D
R16h	Select Drive Pin and Slew Rate for Drive Line 14	W	1	[7:5] Slew rate [4:0] Drive pin select	0x0E
R17h	Select Drive Pin and Slew Rate for Drive Line 15	W	1	[7:5] Slew rate [4:0] Drive pin select	0x0F
R18h	Select Drive Pin and Slew Rate for Drive Line 16	W	1	[7:5] Slew rate [4:0] Drive pin select	0x10
R19h	Select Drive Pin and Slew Rate for Drive Line 17	W	1	[7:5] Slew rate [4:0] Drive pin select	0x11

R1Ah	Select Drive Pin and Slew Rate for Drive Line 18	W	1	[7:5] Slew rate [4:0] Drive pin select	0x12
R1Bh	Select Drive Pin and Slew Rate for Drive Line 19	W	1	[7:5] Slew rate [4:0] Drive pin select	0x13
R1Ch	Select Drive Pin and Slew Rate for Drive Line 20	W	1	[7:5] Slew rate [4:0] Drive pin select	0x14
R1Dh~ R22h	Reserved				
R23h	System Enable (wake-up)	C	1	Dummy Byte. For example, 0x00 can be sent. (No Ack for the dummy byte)	N/A
R24h	System Disable (go to sleep)	C	1	Dummy Byte. For example, 0x00 can be sent. (No Ack for the dummy byte)	N/A
R25h	Write Operation Mode	W	1	[7:4]: Reserved [3:0]: 0000 = Idle mode 0001 = Idle mode 0010 = Fast Scan, 200Hz 0011 = Fast Scan, 166Hz 0100 = Fast Scan, 142Hz 0101 = Fast Scan, 125Hz 0110 = Fast Scan, 100Hz 0111 = Normal Scan, 83.3Hz 1000 = Normal Scan, 71.4Hz 1001 = Normal Scan, 62.5Hz 1010 = Normal Scan, 55.5Hz 1011 = Normal Scan, 50.0Hz 1100 = Slow Scan, 45.5Hz 1101 = Slow Scan, 37.0Hz 1110 = Slow Scan, 30.3Hz 1111 = Slow Scan, 25.0Hz	0x00
R26h	Read Operation Mode	R	1	Ditto	0x00
R27h	Set Power Down Time	W	1	[7:3]: Reserved [2:0]: 000 = 200ms (5Hz) 001 = 140ms (7Hz) 010 = 100ms (10Hz) 011 = 70ms (14Hz) 100 = 50ms (20Hz) 101 = 35ms (28Hz) 110 = 25ms (40Hz) 111 = 17.7ms (56Hz)	0x04
R28h	Set No. of Frames escape without finger touch before entering Power Save Mode.	W	1	[7:4]: Reserved [3:0]: 0000 = 20 frames 0001 = 40 frames 0010 = 60 frames 0011 = 80 frames 0100 = 100 frames 0101 = 120 frames 0110 = 140 frames 0111 = 160 frames 1000 = 180 frames 1011 = 200 frames 1011 = 220 frames 1011 = 240 frames 1100 = 260 frames 1101 = 280 frames 1110 = 300 frames	0x08

				1111 = 320 frames	
R29h	Number of idle cycles insert between driving two rows.	W	1	[7:3]: Reserved [2:0]: No. of idle cycles – 2 Range: 2 – 9 cycles	0x07
R2Ah	Number of Sub Frames per frame scan.	W	1	[7:4]: Reserved [3:0]: No. of sub frames – 1 Range: 1 – 4 sub frames	0x03
R2Bh	Clock Domain Enable	W	1	[7:2]: Reserved [1]: 1: enable DSP clock domain 0: disable DSP clock domain [0]: 1: enable SelfCap clock domain 0: disable SelfCap clock domain	0x00
R2Dh~ R32h	Reserved				
R33h	Min Finger Area (in unit of crossover points)	W	1	[7:0]: set minimum area for valid finger detection	0x02
R34h	Min Finger Level (in unit of delta difference)	W	1	[7:0] set minimum level for valid finger detection	0x05
R35h	Min Finger Weight (in unit of delta difference)	W	2	[15:0]: set minimum weight for valid finger detection	0x00 0x0A
R36h	Max Finger Area (in unit of crossover points)	W	1	[7:0]: set maximum area for valid finger detection	0x1E
R37h	Control depth of image segmentation	W	1	[7:2]: Reserved [1:0]: 0 = 68% of max value 1 = 63% of max value 2 = 56% of max value 3 = 49% of max value	0x00
R38h	Select Delta Data Range	W	1	[7:2]: Reserved [1:0]: 00 = delta_data[7:0] 01 = delta_data[8:1] 10 = delta_data[9:2] 11 = delta_data[10:3]	0x00
R39h	Select CG calculation method	W	1	[7:1]: reserved [0]: 0 = Weighted Avg. 1 = Curve Fitting	0x00
R3Ah	Enable filtering in init calibration sequence	W	1	[7:1]: reserved [0]: 0 = disable filter 1 = enable filter	0x00
R3Bh~ R3Ch	Reserved				
R3Dh	Select filter type for delta data	W	1	[7:2]: Reserved [1:0]: 0: 1-6-1 filter 1: 1-2-1 filter 2: no filter	0x00
R3Eh	Switch off auto calibration	W	1	[7:1]: Reserved [0]: 0: auto calibration on 1: auto calibration off	0x00
R3Fh~ R50h	Reserved				
R51h	Single Click Timing	W	2	[15:11]: Reserved	0x00

	(in 1ms unit)			[10:0]: define single click timing	0x00
R52h	Double Click Timing (in 1ms unit)	W	2	[15:11]: Reserved [10:0]: define double click timing	0x00 0x00
R53h	CG Tolerance (in 1/32 electrode span)	W	1	[7]: Reserved [6:0]: define CG tolerance	0x00
R54h	X Tracking tolerance (in 1/32 electrode span)	W	1	[7:0]: X coordinate tracking tolerance	0x00
R55h	Y Tracking tolerance (in 1/32 electrode span)	W	1	[7:0] Y coordinate tracking tolerance	0x00
R56h	Enable Adaptive Moving Average filter to smooth fingers' output coordinates.	W	1	[7:1]: reserved [0]: 0 = disable filter 1 = enable filter	0x00
R57h	Select the scaling factor for finger speed (in 1/32 electrode span)	W	1	[7:1] Reserved [0]: 0: select distance[5:2] 1: select distance[6:3]	0x00
R58h	Select the scaling factor for finger press weight (in unit of a delta difference)	W	1	[7:2]: reserved [1:0]: 00 = weight/1 01 = weight/2 10 = weight/4 11 = weight/8	0x00
R59h	Enable move tolerance for absolute coordinate reporting	W	1	[7:1] Reserved [0]: 0: disable CG tolerance for absolute coordinate reporting 1: enable CG tolerance for absolute coordinate reporting	0x00
R5Ah	Define number of maximum missed frame	W	1	[7:4]: Reserved [3:0]: Number of maximum missed frame(0- 15)	0x04
R5Bh	Define the tolerance window for a finger move	W	1	[7]: Reserved [6:0]: Define move tolerance in pixel for event mode	0x01
R5Ch~ R64h	Reserved				
R65h	Remap fingers' coordinates according to different orientation	W	1	[7:3]: Reserved [2:0]: 000: Normal 001: Y-Invert 010: X-Invert 011: X-Invert + Y-Invert 100: Transpose 101: Transpoe + X-Invert (270 deg) 110: Transpose + Y-Invert (90 deg) 111: Transpose + X-Invert + Y-Invert	0x00

R66h	Scaling factor for X coordinate. Floating point format is ##.#####.	W	1	[7:0]: X scaling factor. 2-bit integer part and 6-bit fractional part.	0x40
R67h	Scaling factor for Y coordinate. Floating point format is ##.#####.	W	1	[7:0]: Y scaling factor. 2-bit integer part and 6-bit fractional part.	0x40
R68h	Offset of X coordinate. (in unit of pixel. That is, after X scaling)	W	1	[7:6]: reserved [5:0]: X offset	0x00
R69h	Offset of Y coordinate. (in unit of pixel. That is, after Y scaling)	W	1	[7:6]: reserved [5:0]: Y offset	0x00
R6Ah~ R78h	Reserved				
R79h	Event Status	R	1	[7]: Reserved [6]: Large Object detected [5]: FIFO overflow [4]: FIFO not empty [3]: Finger 3 detected [2]: Finger 2 detected [1]: Finger 1 detected [0]: Finger 0 detected	N/A
R7Ah	Event Mask	W	2	[15]: Unknown event mask [14:8]: Reserved [7]: FM Event mask [6]: FL Event mask [5]: FE Event mask [4]: DFDC Event mask [3]: DFSC Event mask [2]: SFDC Event mask [1]: SFSC Event mask [0]: Reserved	0x00 0x00
R7Bh	IRQ Mask	W	1	[7]: Reserved [6]: Large Object status mask [5]: FIFO overflow status mask [4]: FIFO not empty status mask [3]: Finger03 status mask [2]: Finger02 status mask [1]: Finger01 status mask [0]: Finger00 status mask	0x00
R7Ch	Finger01 (X,Y) coordinates, speed index and press weight index.	R	4	[31:24]: x-coordinate[7:0] [23:16]: y-coordinate[7:0] [15:12]: x-coordinate [11:8] [11:08]: y-coordinate [11:8] [07:04]: press weight index[3:0] [03:00]: speed index [3:0]	0xFF 0xFF 0xFF 0x00
R7Dh	Finger02 (X,Y) coordinates, speed index and press weight index.	R	4	Ditto	Ditto
R7Eh	Finger03 (X,Y) coordinates, speed index and press weight index.	R	4	Ditto	Ditto
R7Fh	Finger04 (X,Y) coordinates, speed index and press weight index.	R	4	Ditto	Ditto

R80h	Event Stack	R	4	[31:28]: Finger flag [3:0] [27:24]: Event number [3:0] [23:16]: x-coordinate[7:0] [15:08]: y-coordinate[7:0] [07:04]: x-coordinate [11:8] [03:00]: y-coordinate [11:8]	0x00 0xFF 0xFF 0xFF
R81h	Event Stack Clear	C	0	Clear the Event Stack	N/A
R82h~ RA1h	Reserved				
RA2h	Reset Init Reference Procedure	W	1	Dummy Byte For example, 0x00 can be sent.	N/A
RA3h~ RAAh	Reserved				
RABh	The number of the accumulated charged/discharged pulses	W	1	[7:0] The number of Self-cap accumulated pulses	0x64
RACH	The weight of IIR low-pass filter for self cap button	W	1	[7:2]:Reserved [1:0] 0: divide by 2 1: divide by 4 2: divide by 8 3: divide by 16	0x00
RADh	Self-capacitive sensor scan rate frequency	W	1	[7:2]:Reserved [1:0] 0: 20Hz 1: 30Hz 2: 40Hz 3: 50Hz	0x00
RAEh	Enable specific channel of self-cap sensor	W	1	[7:4] Reserved [3:0] : [3]: channel 3 enable [2]: channel 2 enable [1]: channel 1 enable [0]: channel 0 enable	0x0F
RAFh	The threshold of a valid self cap sensed touch	W	1	[7]: Reserved [6:0] threshold level	0x1E
RB0h	TBD	TBD	TBD	TBD	TBD
RB1h~ RB8h	Reserved				
RB9h	Read the self cap status	R	1	[7:4]: Reserved [3]: Channel 3 status 1: touch 0: untouch [2]: Channel 2 status 1: touch 0: untouch [1]: Channel 1 status 1: touch 0: untouch [0]: Channel 0 status 1: touch 0: untouch	
RBAh	Self cap IRQ mask	W	1	[7:4]: Reserved [3]: Channel 3 irq mask [2]: Channel 2 irq mask [1]: Channel 1 irq mask [0]: Channel 0 irq mask	0x00

RBBh	Reserved				
RBCb	Enable self cap	W	1	[7:1] Reserved [0]: 1 enable 0 disable	0x00
RBDh ~RC0h	Reserved				
RC1h	Charge Pump 2 nd Booster Control	W	1	[7:6]: Reserved [5:4]: 2 nd Booster Control 00: x6 01: Reserved 10: x5 11: x4 [3:0]: Reserved	0x32
RC2h~ RD4h	Reserved				
RD5h	Select Driving voltage level	W	1	[7:4]: reserved [3:0]: 0 = 8.0V, 1 = 8.5V 2 = 9.0V, 3 = 9.5V 4 = 10.0V, 5 = 10.5V 6 = 11.0V, 7 = 11.5V 8 = 12.0V, 9 = 12.5V 10 = 13.0V, 11 = 13.5V 12 = 14.0V, 13 = 14.5V 14 = 15.0V, 15 = 15.5V	0x00
RD6h~ RD7h	Reserved				
RD8h	Selectable sampling delay	W	1	[1:0]: 00 0ns 01 20ns 10 40ns 11 60ns	0x00
RD9h	Enable sense filter	W	1	[0]: 0 = sense filter off 1 = sense filter on	0x00
RDAh~ RDDh	Reserved				

9 COMMAND DESCRIPTIONS

No Operation (R00h)

No Operation for this command.

Software Reset (R01h)

This command reset all the register to the POR state.

Read Device ID Register (R02h)

R/W	Parameter	IB7	IB6	IB5	IB4	IB3	IB2	IB1	IB0
R	1	0	0	1	0	0	1	0	1
R	2	0	0	1	1	0	0	0	1
	POR	0	0	1	0	0	1	0	1
	POR	0	0	1	1	0	0	0	1

This register returned the Device ID “2531h”.

Drive Line Number Register (R06h)

R/W	Parameter	IB7	IB6	IB5	IB4	IB3	IB2	IB1	IB0
W	1	--	--	--	--	Drive_No			
	POR	0	0	0	0	1	1	1	1

The number of driving lines can be ranged from minimum 6 to maximum 21. Touch Panel with less than 6x6 ITO tracks is not support.

Drive_No	Driving Line Number
0000	6
0001	7
:	:
:	Step = 1
:	:
1110	20
1111	21 (default)

Sense Line Number Register (R07h)

R/W	Parameter	IB7	IB6	IB5	IB4	IB3	IB2	IB1	IB0
W	1	--	--	--	--	--	Sense_No		
	POR	0	0	0	0	0	1	1	0

The number of sensing lines can be ranged from minimum 6 to maximum 12. Touch Panel with less than 6x6 ITO tracks is not support.

Sense_No	Sensing Line Number
000	6
001	7
:	:
:	Step = 1
:	:
110	12 (default)
111	N/A

Select Drive Pin and Slew Rate for Drive Line 00 (R08h)

R/W	Parameter	IB7	IB6	IB5	IB4	IB3	IB2	IB1	IB0
W	1	Slew rate control			Drive pin selection				
	POR	0	0	0	0	0	0	0	0

Set the slew rate and the scanning sequence of the driver line 0.

Slew rate control	Rise/Fall time
000	40
001	60
011	90
111	135

Drive Line selection	Drive line order
00000	1 (default)
00001	2
:	:
:	:
10011	20
10100	21

Select Drive Pin and Slew Rate for Drive Line 01 (R09h)

R/W	Parameter	IB7	IB6	IB5	IB4	IB3	IB2	IB1	IB0
W	1	Slew rate control			Drive pin selection				
	POR	0	0	0	0	0	0	0	1

Set the slew rate and the scanning sequence of the driver line 1.

Slew rate control	Rise/Fall time
000	40
001	60
011	90
111	135

Drive Line selection	Drive line order
00000	1
00001	2 (default)
:	:
:	:
10011	20
10100	21

Select Drive Pin and Slew Rate for Drive Line 02 (R0Ah)

R/W	Parameter	IB7	IB6	IB5	IB4	IB3	IB2	IB1	IB0
W	1	Slew rate control			Drive pin selection				
	POR	0	0	0	0	0	0	1	0

Set the slew rate and the scanning sequence of the driver line 2.

Slew rate control	Rise/Fall time
000	40
001	60
011	90

111	135
Drive Line selection	Drive line order
00000	1
00001	2
00010	3 (default)
:	:
10011	20
10100	21

Select Drive Pin and Slew Rate for Drive Line 03 (R0Bh)

R/W	Parameter	IB7	IB6	IB5	IB4	IB3	IB2	IB1	IB0
W	1	Slew rate control			Drive pin selection				
	POR	0	0	0	0	0	0	1	1

Set the slew rate and the scanning sequence of the driver line 3.

Slew rate control	Rise/Fall time
000	40
001	60
011	90
111	135

Drive Line selection	Drive line order
00000	1
:	:
00011	4 (default)
:	:
10011	20
10100	21

Select Drive Pin and Slew Rate for Drive Line 04 (R0Ch)

R/W	Parameter	IB7	IB6	IB5	IB4	IB3	IB2	IB1	IB0
W	1	Slew rate control			Drive pin selection				
	POR	0	0	0	0	0	1	0	0

Set the slew rate and the scanning sequence of the driver line 4.

Slew rate control	Rise/Fall time
000	40
001	60
011	90
111	135

Drive Line selection	Drive line order
00000	1
:	:
00100	5 (default)
:	:
10011	20
10100	21

Select Drive Pin and Slew Rate for Drive Line 05 (R0Dh)

R/W	Parameter	IB7	IB6	IB5	IB4	IB3	IB2	IB1	IB0
W	1	Slew rate control			Drive pin selection				
	POR	0	0	0	0	0	1	0	1

Set the slew rate and the scanning sequence of the driver line 5.

Slew rate control	Rise/Fall time
000	40
001	60
011	90
111	135

Drive Line selection	Drive line order
00000	1
:	:
00101	6 (default)
:	:
10011	20
10100	21

Select Drive Pin and Slew Rate for Drive Line 06 (R0Eh)

R/W	Parameter	IB7	IB6	IB5	IB4	IB3	IB2	IB1	IB0
W	1	Slew rate control			Drive pin selection				
	POR	0	0	0	0	0	1	1	0

Set the slew rate and the scanning sequence of the driver line 6.

Slew rate control	Rise/Fall time
000	40
001	60
011	90
111	135

Drive Line selection	Drive line order
00000	1
:	:
00110	7 (default)
:	:
10011	20
10100	21

Select Drive Pin and Slew Rate for Drive Line 07 (R0Fh)

R/W	Parameter	IB7	IB6	IB5	IB4	IB3	IB2	IB1	IB0
W	1	Slew rate control			Drive pin selection				
	POR	0	0	0	0	0	1	1	1

Set the slew rate and the scanning sequence of the driver line 7.

Slew rate control	Rise/Fall time
000	40
001	60
011	90
111	135

Drive Line selection	Drive line order
00000	1
:	:
00111	8 (default)
:	:
10011	20
10100	21

Select Drive Pin and Slew Rate for Drive Line 08 (R10h)

R/W	Parameter	IB7	IB6	IB5	IB4	IB3	IB2	IB1	IB0
W	1	Slew rate control			Drive pin selection				
	POR	0	0	0	0	1	0	0	0

Set the slew rate and the scanning sequence of the driver line 8.

Slew rate control	Rise/Fall time
000	40
001	60
011	90
111	135

Drive Line selection	Drive line order
00000	1
:	:
01000	9 (default)
:	:
10011	20
10100	21

Select Drive Pin and Slew Rate for Drive Line 09 (R11)

R/W	Parameter	IB7	IB6	IB5	IB4	IB3	IB2	IB1	IB0
W	1	Slew rate control			Drive pin selection				
	POR	0	0	0	0	1	0	0	1

Set the slew rate and the scanning sequence of the driver line 9.

Slew rate control	Rise/Fall time
000	40
001	60
011	90
111	135

Drive Line selection	Drive line order
00000	1
:	:
01001	10 (default)
:	:
10011	20
10100	21

Select Drive Pin and Slew Rate for Drive Line 10 (R12h)

R/W	Parameter	IB7	IB6	IB5	IB4	IB3	IB2	IB1	IB0
W	1	Slew rate control			Drive pin selection				
	POR	0	0	0	0	1	0	1	0

Set the slew rate and the scanning sequence of the driver line 10.

Slew rate control	Rise/Fall time
000	40
001	60
011	90
111	135

Drive Line selection	Drive line order
00000	1
:	:
01010	11 (default)
:	:
10011	20
10100	21

Select Drive Pin and Slew Rate for Drive Line 11 (R13h)

R/W	Parameter	IB7	IB6	IB5	IB4	IB3	IB2	IB1	IB0
W	1	Slew rate control			Drive pin selection				
	POR	0	0	0	0	1	0	1	1

Set the slew rate and the scanning sequence of the driver line 11.

Slew rate control	Rise/Fall time
000	40
001	60
011	90
111	135

Drive Line selection	Drive line order
00000	1
:	:
01011	12 (default)
:	:
10011	20
10100	21

Select Drive Pin and Slew Rate for Drive Line 12 (R14h)

R/W	Parameter	IB7	IB6	IB5	IB4	IB3	IB2	IB1	IB0
W	1	Slew rate control			Drive pin selection				
	POR	0	0	0	0	1	1	0	0

Set the slew rate and the scanning sequence of the driver line 12.

Slew rate control	Rise/Fall time
000	40
001	60
011	90
111	135

Drive Line selection	Drive line order
00000	1
:	:
01100	13 (default)
:	:
10011	20
10100	21

Select Drive Pin and Slew Rate for Drive Line 13 (R15h)

R/W	Parameter	IB7	IB6	IB5	IB4	IB3	IB2	IB1	IB0
W	1	Slew rate control			Drive pin selection				
	POR	0	0	0	0	1	1	0	1

Set the slew rate and the scanning sequence of the driver line 13.

Slew rate control	Rise/Fall time
000	40
001	60
011	90
111	135

Drive Line selection	Drive line order
00000	1
:	:
01101	14 (default)
:	:
10011	20
10100	21

Select Drive Pin and Slew Rate for Drive Line 14 (R16h)

R/W	Parameter	IB7	IB6	IB5	IB4	IB3	IB2	IB1	IB0
W	1	Slew rate control			Drive pin selection				
	POR	0	0	0	0	1	1	1	0

Set the slew rate and the scanning sequence of the driver line 14.

Slew rate control	Rise/Fall time
000	40
001	60
011	90
111	135

Drive Line selection	Drive line order
00000	1
:	:
01110	15 (default)
:	:
10011	20
10100	21

Select Drive Pin and Slew Rate for Drive Line 15 (R17h)

R/W	Parameter	IB7	IB6	IB5	IB4	IB3	IB2	IB1	IB0
W	1	Slew rate control			Drive pin selection				
	POR	0	0	0	0	1	1	1	1

Set the slew rate and the scanning sequence of the driver line 15.

Slew rate control	Rise/Fall time
000	40
001	60
011	90
111	135

Drive Line selection	Drive line order
00000	1
:	:
01111	16 (default)
:	:
10011	20
10100	21

Select Drive Pin and Slew Rate for Drive Line 16 (R18h)

R/W	Parameter	IB7	IB6	IB5	IB4	IB3	IB2	IB1	IB0
W	1	Slew rate control			Drive pin selection				
	POR	0	0	0	1	0	0	0	0

Set the slew rate and the scanning sequence of the driver line 16.

Slew rate control	Rise/Fall time
000	40
001	60
011	90
111	135

Drive Line selection	Drive line order
00000	1
:	:
10000	17 (default)
:	:
10011	20
10100	21

Select Drive Pin and Slew Rate for Drive Line 17 (R19h)

R/W	Parameter	IB7	IB6	IB5	IB4	IB3	IB2	IB1	IB0
W	1	Slew rate control			Drive pin selection				
	POR	0	0	0	1	0	0	0	1

Set the slew rate and the scanning sequence of the driver line 17.

Slew rate control	Rise/Fall time
000	40
001	60
011	90
111	135

Drive Line selection	Drive line order
00000	1
:	:
10001	18 (default)
:	:
10011	20
10100	21

Select Drive Pin and Slew Rate for Drive Line 18 (R1Ah)

R/W	Parameter	IB7	IB6	IB5	IB4	IB3	IB2	IB1	IB0
W	1	Slew rate control			Drive pin selection				
	POR	0	0	0	1	0	0	1	0

Set the slew rate and the scanning sequence of the driver line 18.

Slew rate control	Rise/Fall time
000	40
001	60
011	90
111	135

Drive Line selection	Drive line order
00000	1
:	:
10010	19 (default)
10011	20
10100	21

Select Drive Pin and Slew Rate for Drive Line 19 (R1Bh)

R/W	Parameter	IB7	IB6	IB5	IB4	IB3	IB2	IB1	IB0
W	1	Slew rate control			Drive pin selection				
	POR	0	0	0	1	0	0	1	1

Set the slew rate and the scanning sequence of the driver line 19.

Slew rate control	Rise/Fall time
000	40
001	60
011	90
111	135

Drive Line selection	Drive line order
00000	1
:	:
10011	20 (default)
10100	21

Select Drive Pin and Slew Rate for Drive Line 20 (R1Ch)

R/W	Parameter	IB7	IB6	IB5	IB4	IB3	IB2	IB1	IB0
W	1	Slew rate control			Drive pin selection				
	POR	0	0	0	1	0	1	0	0

Set the slew rate and the scanning sequence of the driver line 20.

Slew rate control	Rise/Fall time
000	40
001	60
011	90
111	135

Drive Line selection	Drive line order
00000	1
:	:
10011	20
10100	21 (default)

System Enable (R23h)

A dummy byte should be sent after this command to enable the system clock, no acknowledgement for the dummy byte.

System Disable (R24h)

A dummy byte should be sent after this command to disable the system clock, no acknowledgement for the dummy byte.

Write Operation Mode (R25h)

R/W	Parameter	IB7	IB6	IB5	IB4	IB3	IB2	IB1	IB0
W	1	--	--	--	--	Op_Mode			
	POR	0	0	0	0	0	0	0	0

SSD2521 has 4 operation modes that can be set through Op_Mode.

Idle Mode - In Idle Mode, no scanning activities will be performed. The analog block will be powered down always.

Slow Scan Mode - In Slow Scan Mode, the scan rate is dropped to 25Hz. This mode is suitable for mobile applications and GUI applications in most cases.

Normal Scan Mode - In Normal Scan Mode, the frame scan rate is 50Hz. This mode is good enough for simple handwriting and gesture. This mode is also recommended for mobile application.

Fast Scan Mode - In Fast Scan Mode, the frame scan rate is running at the maximum of 100Hz. This mode can be used for application like high speed sketching and detailed drawing.

Op_Mode	Scanning Frequency
0000	Idle mode
0001	Idle mode
0010	Fast Scan, 200Hz
0011	Fast Scan, 166Hz
0100	Fast Scan, 142Hz
0101	Fast Scan, 125Hz
0110	Fast Scan, 100Hz
0111	Normal Scan, 83.3Hz
1000	Normal Scan, 71.4Hz
1001	Normal Scan, 62.5Hz

1010	Normal Scan, 55.5Hz
1011	Normal Scan, 50.0Hz
1100	Slow Scan, 45.5Hz
1101	Slow Scan, 37.0Hz
1110	Slow Scan, 30.3Hz
1111	Slow Scan, 25.0Hz

Read Operation Mode (R26h)

R/W	Parameter	IB7	IB6	IB5	IB4	IB3	IB2	IB1	IB0
R	1	--	--	--	--	Op_Mode			
POR		0	0	0	0	0	0	0	0

To clarify the existing operation mode of SSD2521, user can read R_Mode from register address R26h. The value of R_Op_Mode indicates the latest operation mode setting written by Operation Mode Setting Register. SSD2521 has 4 operation modes and 16 settings that can be read.

Power Saving Mode Setting Register (R27h)

R/W	Parameter	IB7	IB6	IB5	IB4	IB3	IB2	IB1	IB0
W	1	--	--	--	--	--	Slow_Scan		
POR		0	0	0	0	0	1	0	0

SSD2521 will enter power saving mode automatically and slow down the panel scanning frequency when there has no touch detected for a predefined period of time. The scan rate of the slow-scan-mode can be set by Slow_Scan as below.

Slow_Scan	Scan Period
000	200ms (5Hz)
001	140ms
010	100ms
011	70ms
100	50ms
101	35ms
110	25ms
111	17.7ms (56Hz)

Finger Esc Timing Register (R28h)

R/W	Parameter	IB7	IB6	IB5	IB4	IB3	IB2	IB1	IB0
W	1	--	--	--	--	Esc_Time			
POR		0	0	0	0	1	0	0	0

This register defined the time period for the system to enter power saving mode. If the system detected there has no finger touch on the panel, the internal timer will start counting down until reaching the value of Esc_Time or a finger touch is present. If the counter reaching the value of Esc_Time, the system will then enter power saving mode and slow down the scanning frequency set by Power Mode Setting Register.

Esc_Time	Esc timing
0000	20 frames
0001	40 frames
0010	60 frames
:	:
:	20 frames / step
:	:
1110	300 frames
1111	320 frames

Number of Idle cycles insert between driving two rows (R29h)

R/W	Parameter	IB7	IB6	IB5	IB4	IB3	IB2	IB1	IB0
W	1	--	--	--	--	--	Idle cycles		
POR		0	0	0	0	0	1	1	1

This register defined the idle time between the driving line and driving line. The range of this register is between 2 to 9 cycles.

Number of sub Frames per frame scan (R2Ah)

R/W	Parameter	IB7	IB6	IB5	IB4	IB3	IB2	IB1	IB0
W	1	--	--	--	--	--	--	Sub_frame	
POR		0	0	0	0	0	0	1	1

This register defined the sensitivity level by the sampling rate. The range of the sub-frame is 1 to 4.

Clock Domain Enable (R2Bh)

R/W	Parameter	IB7	IB6	IB5	IB4	IB3	IB2	IB1	IB0
W	1	--	--	--	--	--	--	Clk_DSP	Clk_SelfC
POR		0	0	0	0	0	0	0	0

This register turned the DSP clock domain and Self cap clock on / off.

Min Finger Area Setting Register (R33h)

R/W	Parameter	IB7	IB6	IB5	IB4	IB3	IB2	IB1	IB0
W	1	Min_Area							
POR		0	0	0	0	0	0	1	0

If the touching area detected is smaller than Min_Area, the system will report “Unknown Event” to the Event Stack.

Min Finger Level Setting Register (R34h)

R/W	Parameter	IB7	IB6	IB5	IB4	IB3	IB2	IB1	IB0
W	1	Min_Level							
POR		0	0	0	0	0	1	0	1

If the touching level detected is smaller than Min_Level, the system will report “Unknown Event” to the Event Stack.

Min Finger Weight Setting Register (R35h)

R/W	Parameter	IB7	IB6	IB5	IB4	IB3	IB2	IB1	IB0
W	1	Min_Weight							
W	2	Min_Weight							
POR		0	0	0	0	0	0	0	0
POR		0	0	0	0	1	0	1	0

Similar to Min Finger Area, user can define also the weight of a valid finger touch. Weight means the summation of the signal level within the touch area.

Max Finger Area Setting Register (R36h)

R/W	Parameter	IB7	IB6	IB5	IB4	IB3	IB2	IB1	IB0
W	1	Max_Area							
POR		0	0	0	1	1	1	1	0

For any touching detected, the system will count the cover area of the touch point and determine if it is a valid finger touch. If the touching area is over Max_Area, the system will report Large Object rather than a finger touch.

Control depth of image segmentation (R37h)

R/W	Parameter	IB7	IB6	IB5	IB4	IB3	IB2	IB1	IB0
W	1	--	--	--	--	--	--	--	Slicing_depth
POR		0	0	0	0	0	0	0	0

Controlling the image segmentation depth can improve the SNR.

Select Delta Data Range (R38h)

R/W	Parameter	IB7	IB6	IB5	IB4	IB3	IB2	IB1	IB0
W	1	--	--	--	--	--	--	--	Delta_data
POR		0	0	0	0	0	0	0	0

This command is used for IC test only.

Select CG calculation method (R39h)

R/W	Parameter	IB7	IB6	IB5	IB4	IB3	IB2	IB1	IB0
W	1	--	--	--	--	--	--	--	CG
POR		0	0	0	0	0	0	0	0

This command is used to improve the stability of different panel.

Enable filtering in init calibration sequence (R3Ah)

R/W	Parameter	IB7	IB6	IB5	IB4	IB3	IB2	IB1	IB0
W	1	--	--	--	--	--	--	--	Filter
POR		0	0	0	0	0	0	0	0

This command is used to enable the filtering in init calibration sequence.

Select filter type for delta data (R3Dh)

R/W	Parameter	IB7	IB6	IB5	IB4	IB3	IB2	IB1	IB0
W	1	--	--	--	--	--	--	--	Type_Filter
POR		0	0	0	0	0	0	0	0

This command is used to select the filter type for the delta data.

Switch off auto calibration (R3Eh)

R/W	Parameter	IB7	IB6	IB5	IB4	IB3	IB2	IB1	IB0
W	1	--	--	--	--	--	--	--	Auto_Cal
POR		0	0	0	0	0	0	0	0

This command is used to switch off the auto calibration.

Single Click Timing (R51h)

R/W	Parameter	IB7	IB6	IB5	IB4	IB3	IB2	IB1	IB0
W	1	--	--	--	--	--	S_Click_Time[10:8]		
W	2	S_Click_Time [7:0]							
POR	1	0	0	0	0	0	0	0	0
	2	0	0	0	0	0	0	0	0

When a finger touch was detected, the system will start a timer counting the present period of the detected finger. If such finger leaves before the timer reaching the value of S_Click_Time, a single click event will be reported.

The setting of S_Click_Time is in 1ms unit.

Double Click Timer Setting Register (R52h)

R/W	Parameter	IB7	IB6	IB5	IB4	IB3	IB2	IB1	IB0
W	1	--	--	--	--	--	--	--	D_Click_Time [9:8]
W	2	D_Click_Time [7:0]							
POR	1	0	0	0	0	0	0	0	0
	2	0	0	0	0	0	0	0	0

When the system established a single click event, the timer will keep counting until reaching the value of D_Click_Time. If a touch is then detected before the timer reaching D_Click_Time, a double click event will be reported.

The setting of D_Click_Time is in 1ms unit.

The following diagram illustrated the timing chart of the click events.

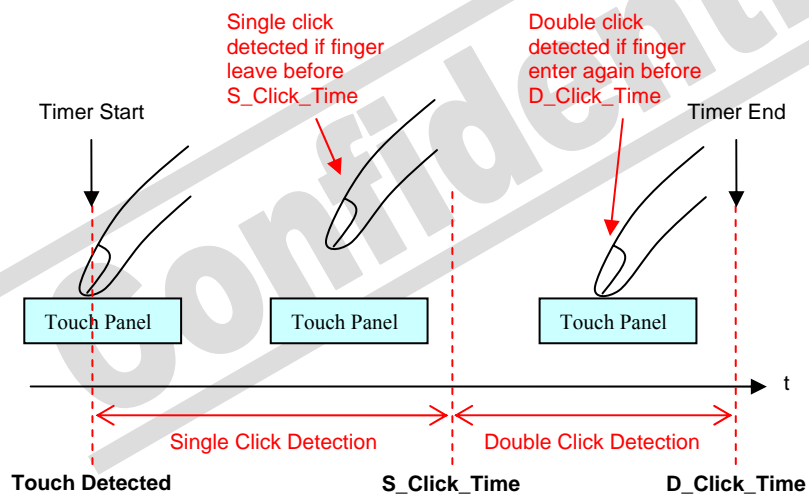

CG Tolerance Setting Register (R53h)

R/W	Parameter	IB7	IB6	IB5	IB4	IB3	IB2	IB1	IB0	
W	1	--	CG_Tole							
POR		0	0	0	0	0	0	0	0	

CG means Center of Gravity which is approximately the center point of the touch area. The setting of CG_Tole indicated how much deviation on a touching point is allowed between two scanning frame.

If the deviation of a touch point is over CG_Tole, it will be treated as a new finger touch and lost track with pervious touch finger number. Contrarily, the finger touch will treat as same finger detected previously.

The setting of CG_tole is in unit step.

The concept of touch deviation are showed below.

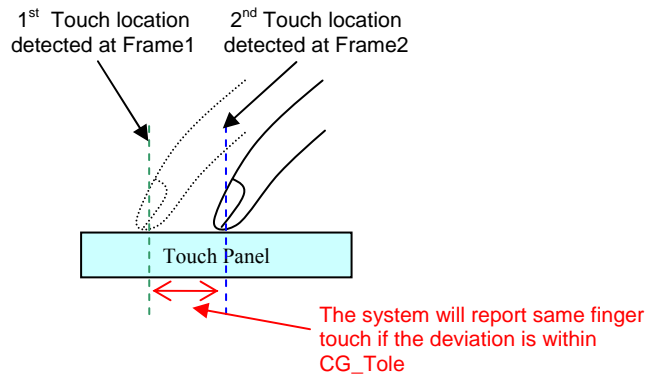

X Tracking Tolerance Register (R54h)

R/W	Parameter	IB7	IB6	IB5	IB4	IB3	IB2	IB1	IB0
W	1	X_Tole							
	POR	0	0	0	0	0	0	0	0

Similar to the CG Tolerance Setting, X_Tole determine the touch point deviation between two scanning frame in X-direction. The finger will lost track if the deviation is too large. This register is mainly for setting the movement tracking condition.

Y Tracking Tolerance Register (R55h)

R/W	Parameter	IB7	IB6	IB5	IB4	IB3	IB2	IB1	IB0
W	1	Y_Tole							
	POR	0	0	0	0	0	0	0	0

Y_Tole determine the touch point deviation between two scanning frame in Y-direction.

Enable Adaptive Moving Average filter to smooth fingers' output coordinates. (R56h)

R/W	Parameter	IB7	IB6	IB5	IB4	IB3	IB2	IB1	IB0
W	1	e-filter							
	POR	0	0	0	0	0	0	0	0

This command is used for noise rejection.

Select the scaling factor for finger speed (R57h)

R/W	Parameter	IB7	IB6	IB5	IB4	IB3	IB2	IB1	IB0
W	1	--	--	--	--	--	--	--	Speed
	POR	0	0	0	0	0	0	0	0

This command is used for set the speed index divided by 4 or 8.

Select the scaling factor for finger press weight (R58h)

R/W	Parameter	IB7	IB6	IB5	IB4	IB3	IB2	IB1	IB0
W	1	--	--	--	--	--	--	Weight_factor	
	POR	0	0	0	0	0	0	0	0

This command is used for set the speed index divided by 4 or 8.

Enable move tolerance for absolute coordinate reporting (R59h)

R/W	Parameter	IB7	IB6	IB5	IB4	IB3	IB2	IB1	IB0
W	1	--	--	--	--	--	--	--	CG_Tol
POR		0	0	0	0	0	0	0	0

This command is used for turning on/off the CG tolerance for absolute coordinate reporting.

Define number of maximum missed frame (R5Ah)

R/W	Parameter	IB7	IB6	IB5	IB4	IB3	IB2	IB1	IB0
W	1	--	--	--	--	Max_Missed_Frame			
POR		0	0	0	0	0	1	0	0

This command is used for setting the number of maximum missed frame (0-15).

Define the tolerance window for a finger move (R5Bh)

R/W	Parameter	IB7	IB6	IB5	IB4	IB3	IB2	IB1	IB0
W	1	--	Move_Tol						
POR		0	0	0	0	0	0	0	1

This command is used to define the move tolerance in pixel for event mode.

Remap fingers' coordinates according to different orientation (R65h)

R/W	Parameter	IB7	IB6	IB5	IB4	IB3	IB2	IB1	IB0
W	1	--	--	--	--	--	Invert		
POR		0	0	0	0	0	0	0	0

This command is used to remap fingers' coordinates with different orientation.

Scaling factor for X coordinate. Floating point format is ##.#####. (R66h)

Test command.

Scaling factor for Y coordinate. Floating point format is ##.#####. (R67h)

Test command.

Offset of X coordinate. (R68h)

Test command.

Offset of Y coordinate. (R69h)

Test command.

Event Status (R79h)

R/W	Parameter	IB7	IB6	IB5	IB4	IB3	IB2	IB1	IB0
R	1	--	LO	OF	NE	F3	F2	F1	F0
POR		0	0	0	0	0	0	0	0

This register showed the status of the touch detection. When a touch event is detected, the IRQ signal will set to low and at least one bit on this register will set to "1" to indicate the touch status. This register is "0" if the IRQ signal is high.

Register	Name	Function
LO	Large Object	If a touch detected with touch area over Max Finger Area (R16h), this bit will set to "1"
OF	FIFO Overflow	This bit will set to "1" if Touch Event Stack has over 8 events stored
NE	FIFO Not Empty	This bit will set to "1" if Touch Event Stack is not empty
F3	Finger3 Detected	If more than 1 finger were detected. This bit will set to "1" indicating the present of 4 th finger
F2	Finger2 Detected	If more than 1 finger were detected. This bit will set to "1" indicating the present of 3 rd finger
F1	Finger1 Detected	If more than 1 finger were detected. This bit will set to "1" indicating the present of 2 nd finger
F0	Finger0 Detected	This bit will set to "1" when 1 st finger touch detected

Event Mask (R7Ah)

R/W	Parameter	IB7	IB6	IB5	IB4	IB3	IB2	IB1	IB0
W	1	UN_M	--	--	--	--	--	--	--
W	2	FM_M	FL_M	FE_M	TFDC_M	TFSC_M	SFDC_M	SFSC_M	--
POR	1	0	0	0	0	0	0	0	0
	2	0	0	0	0	0	0	0	0

The touch event can be masked off by Event Mask Register to simplify the event checking procedure.

"No Event" is not a touch event. It is used as status flag which indicate that the Event Stack is empty when an empty stack is being read.

Similarly, "Unknown Event" is used to indicate a touch has been detected but the touch does not satisfy the requirements set out for any event. These requirements are user programmable.

Please note that "No Event" cannot be masked.

IRQ Mask (R7Bh)

R/W	Parameter	IB7	IB6	IB5	IB4	IB3	IB2	IB1	IB0
W	1	--	LO_M	OF_M	NE_M	F3_M	F2_M	F1_M	F0_M
POR		0	0	0	0	0	0	0	0

The function of the IRQ bit mask is to mask off IRQ due to a particular event status or combination of event statuses. For example, for applications do not need Absolute Coordinate Events, bit 0, 1, 2 and 3 will be masked.

Finger01-04 (X,Y) coordinates, speed index and press weight index. (R7Ch – R7Fh)

R/W	Parameter	IB7	IB6	IB5	IB4	IB3	IB2	IB1	IB0
R	1	x-coor[7:0]							
R	2	y-coor[7:0]							
R	3	x-coor[9:8]				y-coor[9:8]			
R	4	weight index[3:0]				speed index [3:0]			
POR	1	1	1	1	1	1	1	1	1
	2	1	1	1	1	1	1	1	1
	3	1	1	1	1	1	1	1	1
	4	0	0	0	0	0	0	0	0

SSD2521 can detect maximum of 4 fingers touch on the panel. The fifth or more finger touch will be ignored by the system. Four registers are used to report the x-y coordinate of the 4 fingers if present and only the most concurrent coordinates are reported.

The first touch point will put to R7Ch and the second touch point will put to R7Dh and so on. Once the finger number had been assigned, the system will keep tracking the same finger and update the latest x-y coordinate to same register until the finger leaving the touch screen.

Event Stack (R80h)

R/W	Parameter	IB7	IB6	IB5	IB4	IB3	IB2	IB1	IB0
R	1	Finger_Flag				Event_No			
R	2	x-coor[7:0]							
R	3	y-coor[7:0]							
R	4	--	--	x-coor[9:8]		--	--	y-coor[9:8]	
POR	1	0	0	0	0	0	0	0	0
	2	1	1	1	1	1	1	1	1
	3	1	1	1	1	1	1	1	1
	4	0	0	1	1	0	0	1	1

SSD2521 has a hardware interrupt line (IRQ) connected to the host processor. This interrupt line is active low and different kinds of events can activate this IRQ line. In any cases, at least one bit of the Touch Event Status

Register (R02h) will be “1”. If all bits of the Touch Event Status Register are “0”, the IRQ line will return to its inactive state (high). The IRQ can be activating by 1, 2 and 3 fingers only. The fourth finger will not trigger any interrupt event.

The following diagram shows the relationship between Touch Events, Event Stack, IRQ line and IIC interface. The IRQ line will change back to inactive high when the last bit of the last event is transferred from the event stack to the host processor.

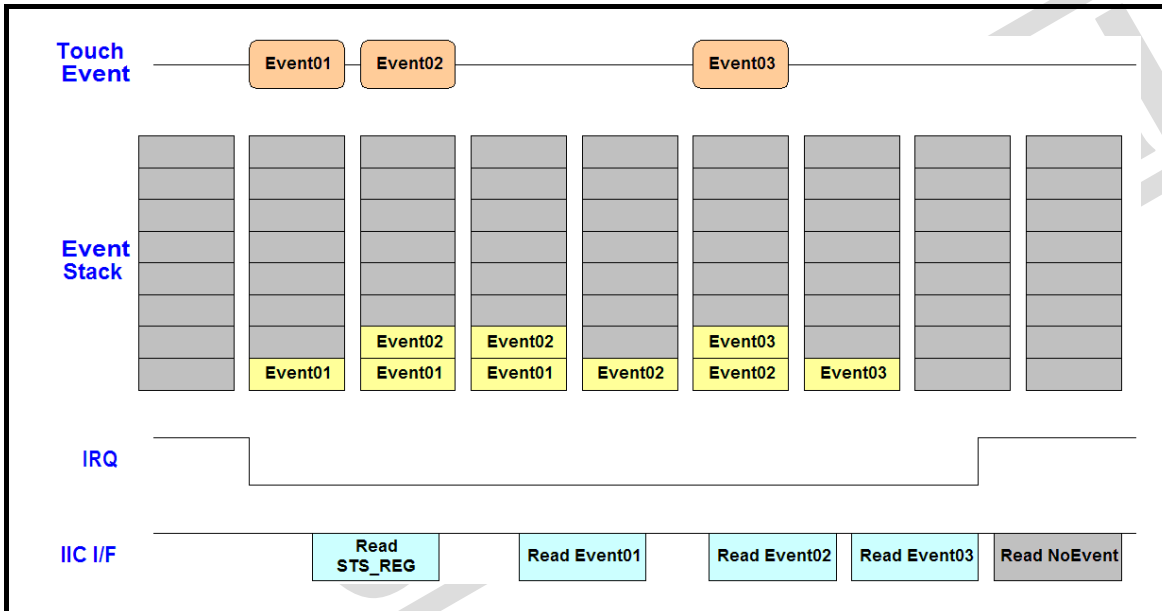

The Event Stack has a capacity to store eight events. If events are not handled by the host processor, they are stuck in the Event Stack. Once the FIFO is full, no more entry for new events is possible. The events must be read out or cleared by command Event Stack Clear (R0Fh) before new entries are available.

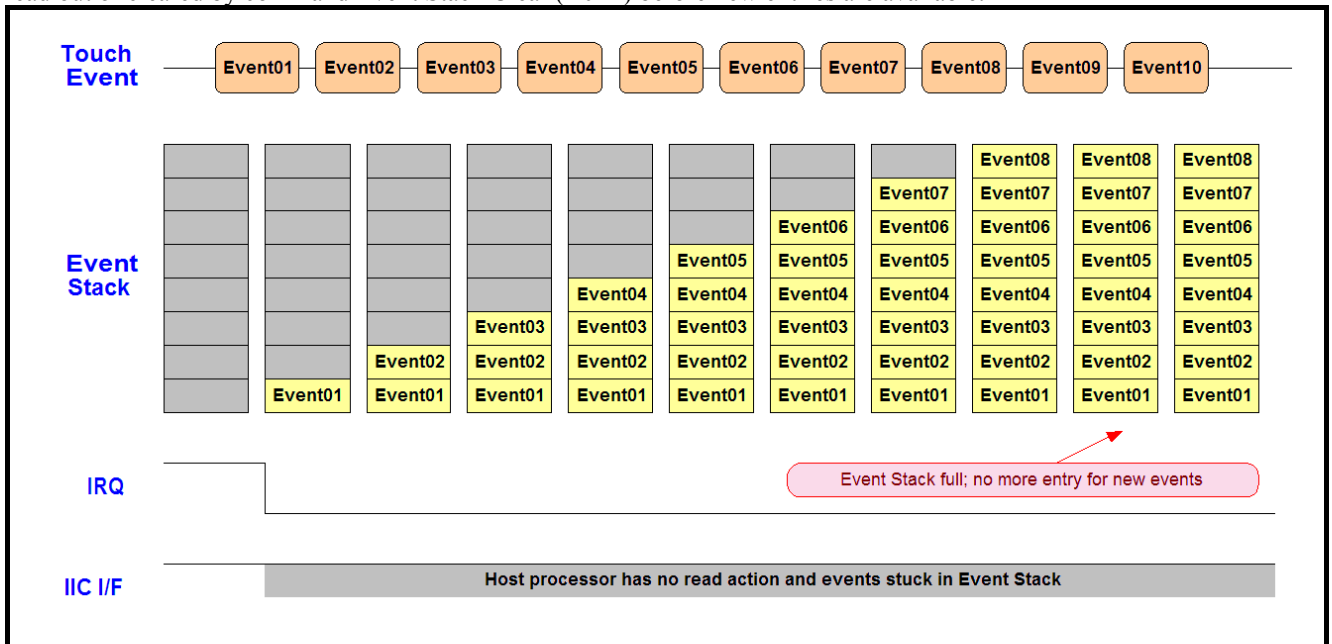

The event number on the Touch Event Stack illustrates the type of the touch event. There are 7 types of Event as tabulated below.

Event number	Event Type
0	No Event
1	Single Finger Single Click (SFSC) Event
2	Single Finger Double Click (SFDC) Event
3	Two Fingers Single Click (TFSC) Event
4	Two Fingers Double Click (TFDC) Event
5	Finger-Enter (FE) Event (per finger base)
6	Finger-Leave (FL) Event (per finger base)
7	Finger-move (FM) Event (per finger base)
8 ~ 14	Reserved
15	Unknown Event (UN)

Event Stack Clear (R81h)

This command is used for clear the event stack. If overflow occurred, the event stack cannot be cleared. All the data in the event stack should be read.

Reset Init Reference Procedure (RA2h)

A dummy byte should be sent after this command to activate the init reference procedure again

The number of the accumulated charged/discharged pulses (RABh)

R/W	Parameter	IB7	IB6	IB5	IB4	IB3	IB2	IB1	IB0
W	1	Accumulated_pulses							
	POR	0	1	1	0	0	1	0	0

This register is for setting the number of accumulated pulses.

The weight of IIR low-pass filter (RACH)

R/W	Parameter	IB7	IB6	IB5	IB4	IB3	IB2	IB1	IB0
W	1	--	--	--	--	--	--	--	IIR_Weight
	POR	0	0	0	0	0	0	0	0

This register is for setting the weight of IIR low-pass filter.

Self-capacitive sensor scan rate frequency (RADh)

R/W	Parameter	IB7	IB6	IB5	IB4	IB3	IB2	IB1	IB0
W	1	--	--	--	--	--	--	--	SelfC_Scan_Freq
	POR	0	0	0	0	0	0	0	0

This register is for setting scan rate frequency of self cap sensor.

Enable specific channel of self-cap sensor (RAEh)

R/W	Parameter	IB7	IB6	IB5	IB4	IB3	IB2	IB1	IB0
W	1	--	--	--	--	--	--	--	SelfC_Scan_Freq
	POR	0	0	0	0	1	1	1	1

This register is for setting scan rate frequency of self cap sensor.

The threshold of a valid sensed touch (RAFh)

R/W	Parameter	IB7	IB6	IB5	IB4	IB3	IB2	IB1	IB0
W	1	--	Threshold_lv						
	POR	0	0	0	1	1	1	1	0

This register is for setting the threshold level of a valid sensed touch.

Read the self cap status (RB9h)

This register is used to read the self cap touch/untouched status.

Self cap IRQ mask (RBAh)

R/W	Parameter	IB7	IB6	IB5	IB4	IB3	IB2	IB1	IB0
W	1	--	--	--	--	Channel_IRQ_mask			
POR		0	0	0	0	0	0	0	0

This register is for setting the IRQ mask of self cap channel 0~3.

Enable self cap (RBCh)

R/W	Parameter	IB7	IB6	IB5	IB4	IB3	IB2	IB1	IB0
W	1	--	--	--	--	--	--	--	EN_SelfC
POR		0	0	0	0	0	0	0	0

This register is for turning on/off the self cap.

Charge Pump 2nd Booster Control (RC1h) Test Command

Select Driving voltage level (RD5h)

R/W	Parameter	IB7	IB6	IB5	IB4	IB3	IB2	IB1	IB0
W	1	Reserved				DVL			
POR		0	0	0	0	0	0	0	0

This register controls the output voltage of the driving line.

DVL	VCIX4 value
0000	8.0V
0001	8.5V
0010	9.0V
:	:
:	:
:	:
1110	15.0V
1111	15.5V

Enable sense filter (RD9h)

R/W	Parameter	IB7	IB6	IB5	IB4	IB3	IB2	IB1	IB0
W	1	--	--	--	--	--	--	--	EN_SenseFilter
POR		0	0	0	0	0	0	0	0

This register is for turning on/off the sense filter.

10 REGISTERS

VDDIO = VCI = 2.775V

- 1.) Hardware Reset
- 2.) Set the number of driver line.
- 3.) Set the number of sense line.
- 4.) Set the driver line scanning order.
- 5.) Turn on the booster circuit and set the VCIx4 to ~15V.

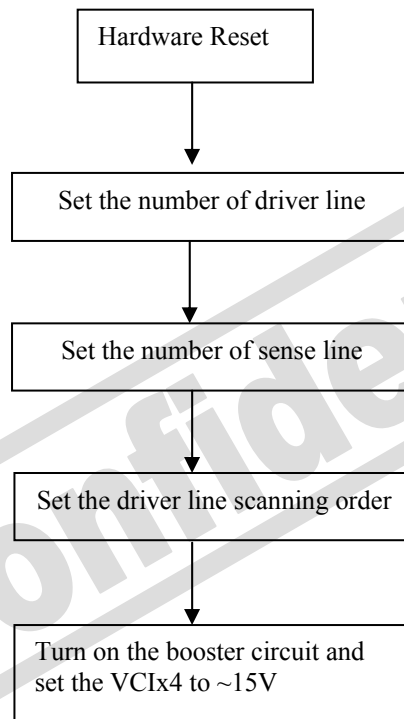

11 MAXIMUM RATINGS

Table 11-1: Maximum Ratings (Voltage Referenced to V_{SS})

Symbol	Parameter	Value	Unit
V _{CORE}	Supply Voltage for Logic	-0.3 to +2.0	V
V _{DDIO}	Supply Voltage for I/O	-0.3 to +4.0	V
V _{CI}	Input Voltage	V _{SS} -0.3 to +5.0	V
I	Current Drain Per Pin Excluding V _{CORE} and V _{SS}	25	mA
T _A	Operating Temperature	-40 to +85	°C
T _{STG}	Storage Temperature	-65 to +150	°C

Maximum ratings are those values beyond which damages to the device may occur. Functional operation should be restricted to the limits in the Electrical Characteristics tables or Pin Description section

This device contains circuitry to protect the inputs against damage due to high static voltages or electric fields; however, it is advised that normal precautions be taken to avoid application of any voltage higher than maximum rated voltages to this high impedance circuit. For proper operation it is recommended that V_{CI} and V_{OUT} be constrained to the range V_{SS} < V_{DD} ≤ V_{CI} < V_{OUT}. Reliability of operation is enhanced if unused input is connected to an appropriate logic voltage level (e.g., either V_{SS} or V_{DD}). Unused outputs must be left open. This device may be light sensitive. Caution should be taken to avoid exposure of this device to any light source during normal operation. This device is not radiation protected.

12 DC CHARACTERISTICS

DC Characteristics (Unless otherwise specified, Voltage Referenced to V_{SS}, T_A = -40 to 85°C)

V _{DDIO}	Power supply pin of I/O pins	Recommend Operating Voltage Possible Operating Voltage	1.65	-	3.3	V
V _{CI}	Booster Reference Supply Voltage Range (3)	Recommend Operating Voltage Possible Operating Voltage	2.5 or V _{DDIO}	-	3.3	V
I _{sleep1}	Sleep mode current (V _{CI} pin)	V _{DDIO} =1.8V, V _{CI} =2.8V	-	TBD	TBD	µA
I _{sleep2}	Sleep mode current (V _{DDIO} pin)		-	TBD	TBD	µA
I _{dp}	Operating mode current	100pF loading at Source output V _{DDEXT} =V _{DDIO} =1.8V, V _{CI} =3.3V I _{DP} = I _{VDDIO} + I _{VDDEXT} + I _{VCI}	-	TBD	TBD	mA
V _{CIX2}	V _{CIX2} primary booster efficiency ¹	TBD	TBD	TBD	-	%
V _{CIX2}	V _{CIX4} secondary booster efficiency ²	TBD	TBD	TBD	-	%
VOH1	Logic High Output Voltage	I _{out} =-100µA	0.9 * V _{DDIO}	-	V _{DDIO}	V
VOL1	Logic Low Output Voltage	I _{out} =100µA	0	-	0.1 * V _{DDIO}	V
VIH1	Logic High Input voltage		0.8 * V _{DDIO}	-	V _{DDIO}	V
VIL1	Logic Low Input voltage		0	-	0.2 * V _{DDIO}	V
I _{OH}	Logic High Output Current Source	V _{OH} = V _{DDIO} -0.4V	50	-	-	µA
I _{OL}	Logic Low Output Current Drain	V _{OL} = 0.4V	-	-	-50	µA
I _{OZ}	Logic Output Tri-state Current Drain Source		-1	-	1	µA
I _{IL} /I _{IH}	Logic Input Current		-1	-	1	µA

Note1: V_{CIX2} efficiency = V_{CIX2} / (2 x V_{CI}) x 100%

Note2: V_{CIX4} efficiency = V_{CIX4} / (V_{CI} x n) x 100% (where n = booster factor)

13 AC CHARACTERISTICS

Conditions:

$$V_{DD} - V_{SS} = 2.4 \text{ to } 3.5V$$

$$V_{DDIO} = V_{DD}$$

$$T_A = 25^\circ C$$

Table 13-1 :I²C Interface Timing Characteristics

Symbol	Parameter	Min	Typ	Max	Unit
t _{cycle}	Clock Cycle Time	2.5	-	-	us
t _{HSTART}	Start condition Hold Time	0.6	-	-	us
t _{HD}	Data Hold Time (for “SDA” pin)	0	-	-	ns
t _{SD}	Data Setup Time	100	-	-	ns
t _{SSTART}	Start condition Setup Time (Only relevant for a repeated Start condition)	0.6	-	-	us
t _{SSTOP}	Stop condition Setup Time	0.6	-	-	us
t _R	Rise Time for data and clock pin	-	-	300	ns
t _F	Fall Time for data and clock pin	-	-	300	ns
t _{IDLE}	Idle Time before a new transmission can start	1.3	-	-	us

Figure 13-1 : I²C interface Timing characteristics

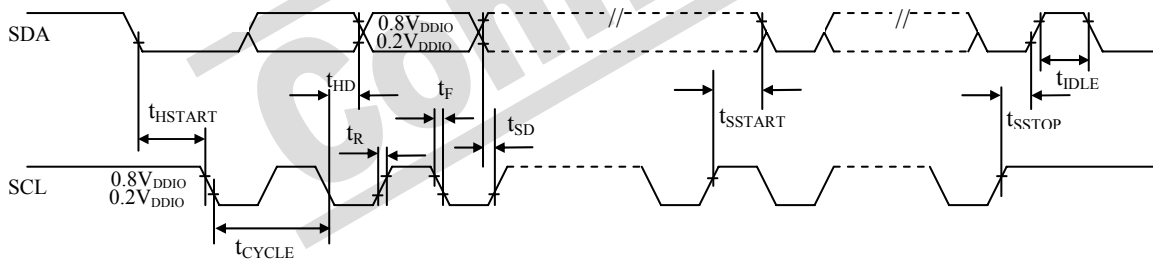

Table 13-2 : Serial Timing Characteristics (TA = -40 to 85 ° C, VDDIO = 2.7V, VSS =0V)

Symbol	Parameter	Min	Typ	Max	Unit
t_{cycle}	Clock Cycle Time	58.8	-	-	ns
t_{AS}	Address Setup Time	10	-	-	ns
t_{AH}	Address Hold Time	5	-	-	ns
t_{CSS}	Chip Select Setup Time	30	-	-	ns
t_{CSH}	Chip Select Hold Time	29.4	-	-	ns
t_{DSW}	Write Data Setup Time	30	-	-	ns
t_{DHW}	Write Data Hold Time	30	-	-	ns
t_{CLKL}	Clock Low Time	29.4	-	-	ns
t_{CLKH}	Clock High Time	29.4	-	-	ns
t_R	Rise Time	-	-	15	ns
t_F	Fall Time	-	-	15	ns

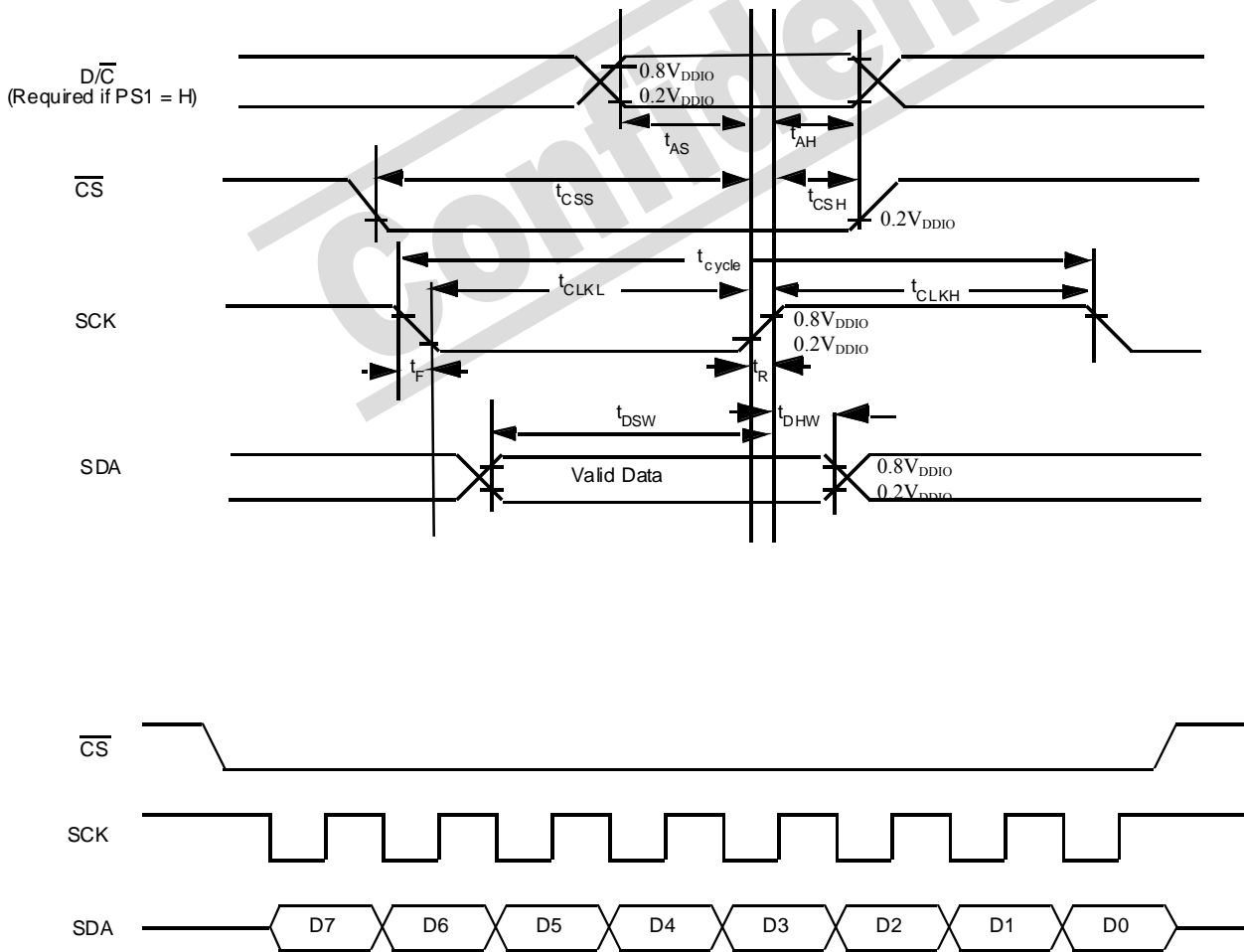
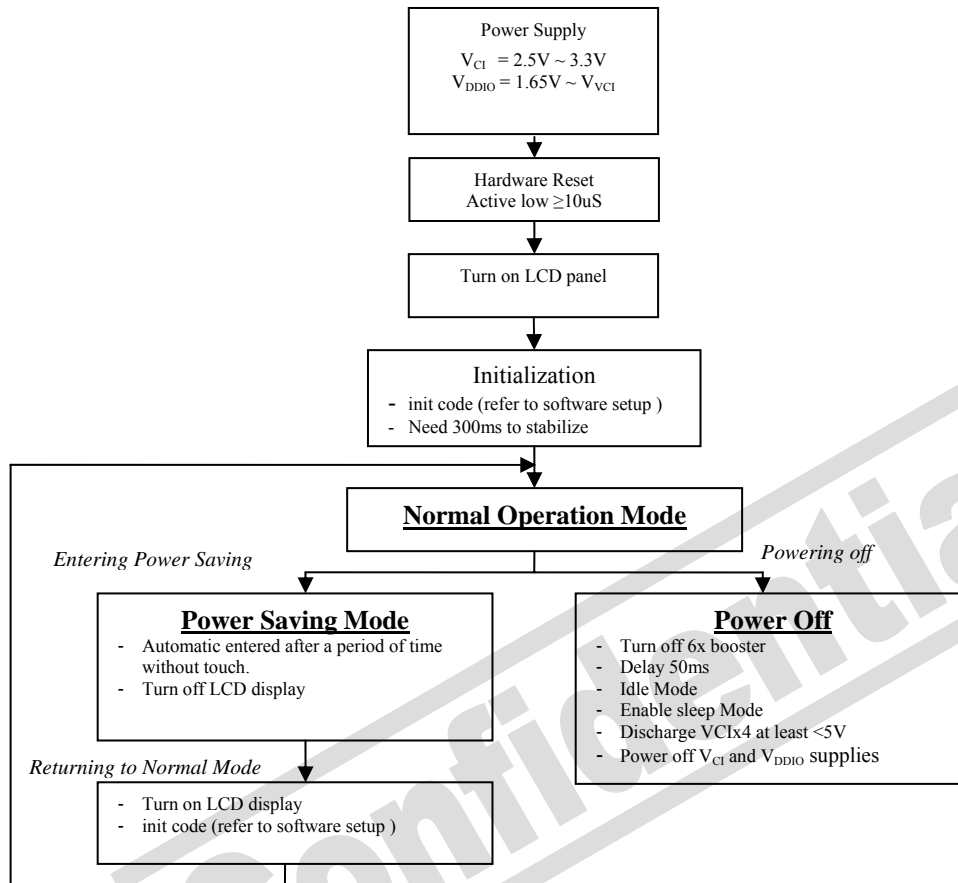

Figure 13-2 : Serial Timing Characteristics

14 Power up/down Sequence

14.1 Power up / down flow chart

The figures below illustrate a flow chart and timing diagram for power up/down sequence of the driver.



Note: To prevent potential damage to the device, all capacitors must be discharged to below 0.5V before the driver is removed from, or before the driver is attached to those components.

14.2 Power up

Symbol	Parameter	Min	Typ	Max	Unit
t_{PR}	Power rise time	-	-	30	us
t_{PD}	Power delay time	-	-	30	us
t_{STABLE}	Chip stable time	-	-	10	us
t_{RES}	Reset pulse	4	-	-	us
t_{READY}	Chip need time after hardware reset	-	-	1	us

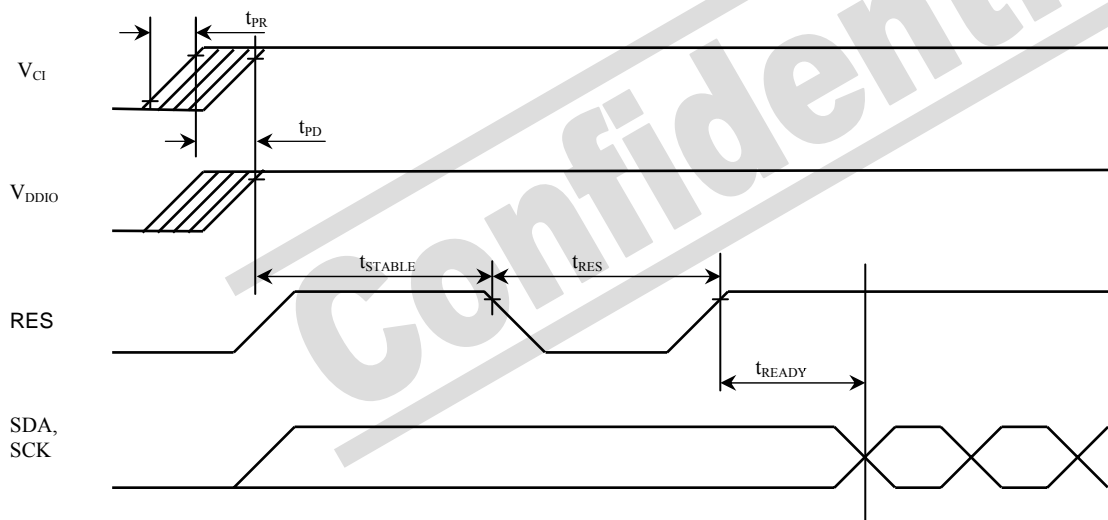

14.3 Power down

Symbol	Parameter	Min	Typ	Max	Unit
$t_{DISCHARGE}$	V_{OUT} discharge wait time	50	-	-	ms
t_{PDOWN}	Power Hold time	50	-	-	ms

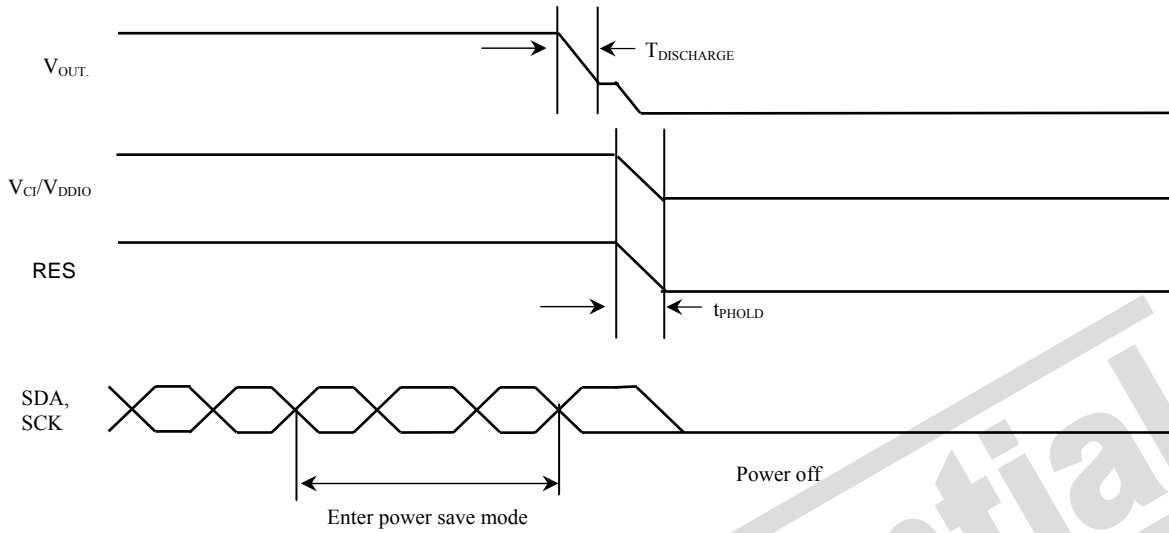

Confidential

- With regards to the Power Off, V_{out} should be discharged at least below than 5V before turn off the V_{CI}/V_{DDIO} power supplies

15 APPLICATION EXAMPLES

15.1 Application Diagram

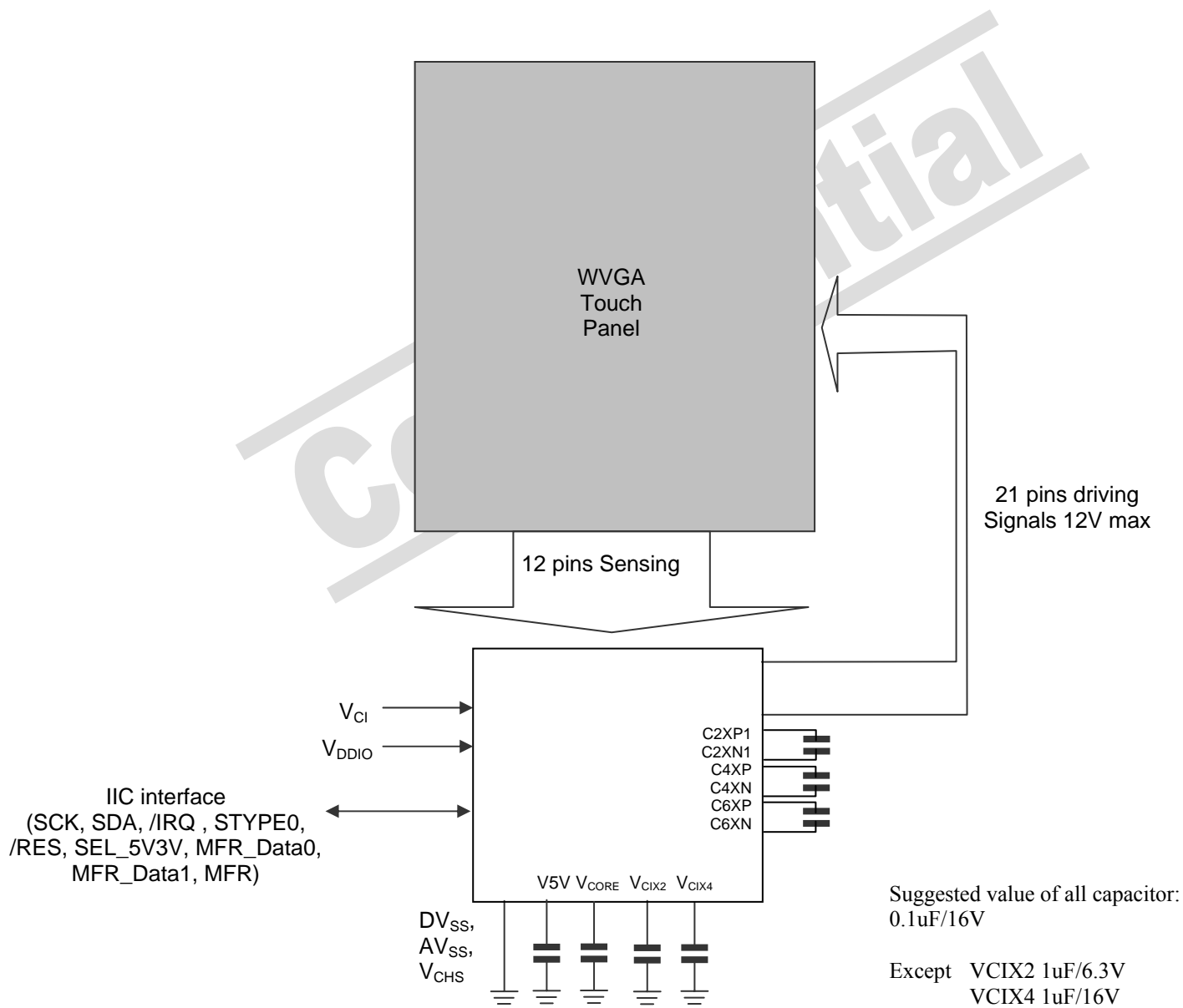

Figure 15-1: Application Example

15.2 Panel design reference

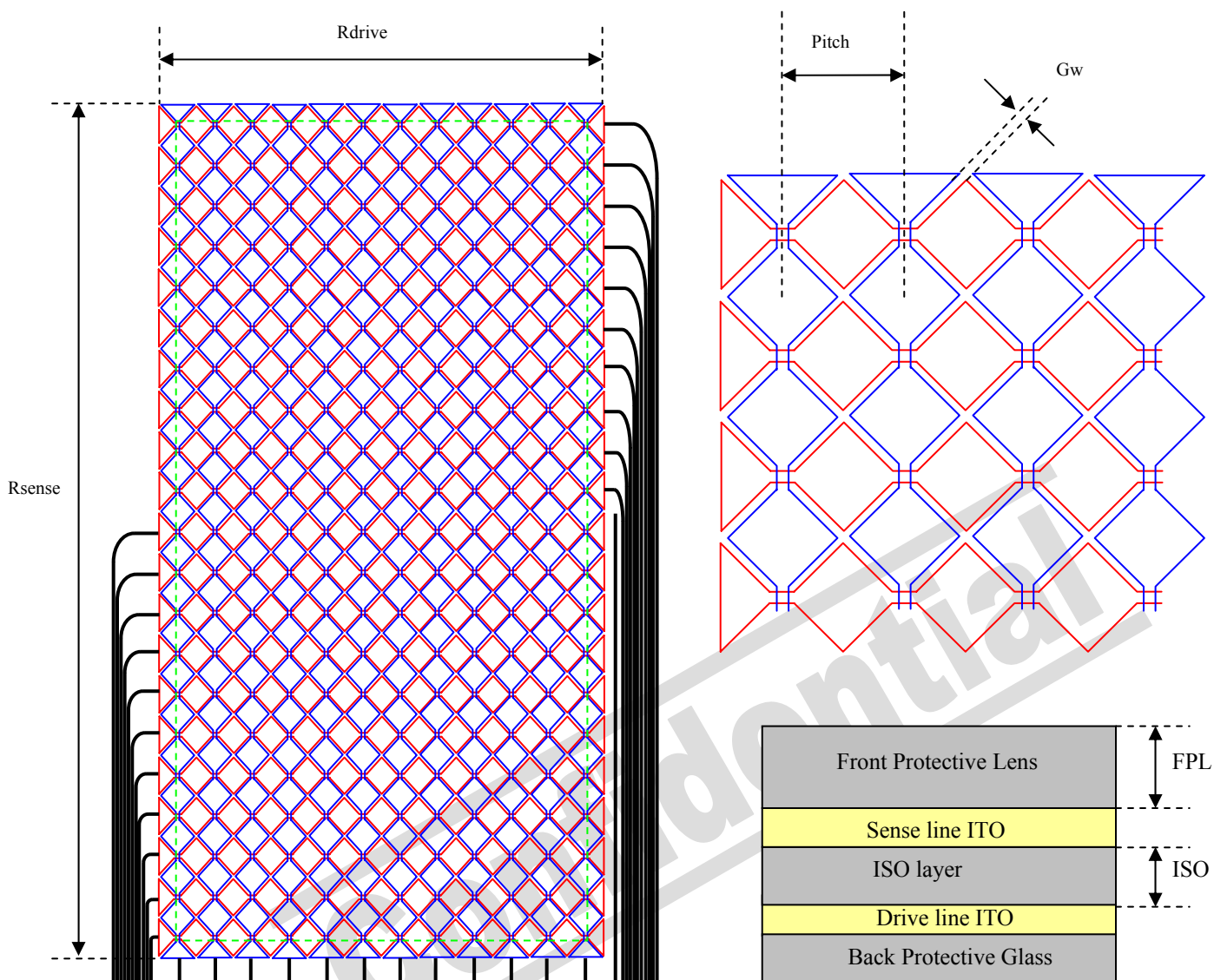
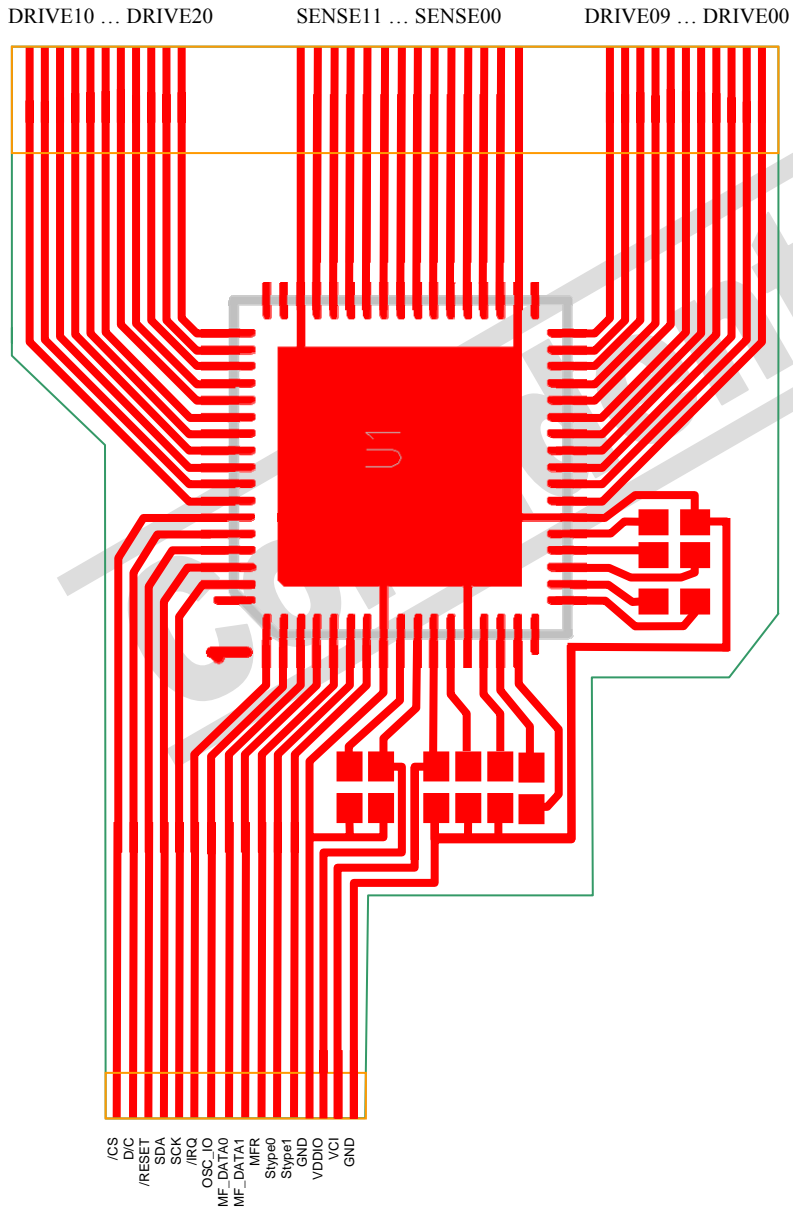

Table 15-1 : Touch Panel Characteristics

Symbol	Parameter	Min	Typ	Max	Unit
R_{drive}	Drive line resistance	-	4	6	$k\Omega$
R_{sense}	Sense line resistance	-	4	6	$k\Omega$
Pitch	Touch pattern pitch	3	-	7	mm
Gw	Pattern Gap width	0.3	0.5	1	mm
ISO	Isolation Glass thickness	-	-	0.6	mm
FPL	Front Protective Lens	-	0.5	-	mm

- Drive line resistance and Sense line resistance included the Diamond pattern, routing trace, FPC and package resistance.
- Metal coating is recommended for the ITO trace.
- GND pin is recommended to insert between the drive and sense line.

15.3 FPC design reference



- *GND pin is recommended to insert between the drive and sense line.*
- *The DRIVE line should not cross over the SENSE line.*

16 PACKAGE INFORMATION

16.1 QFN 68 pins (8x8mm)

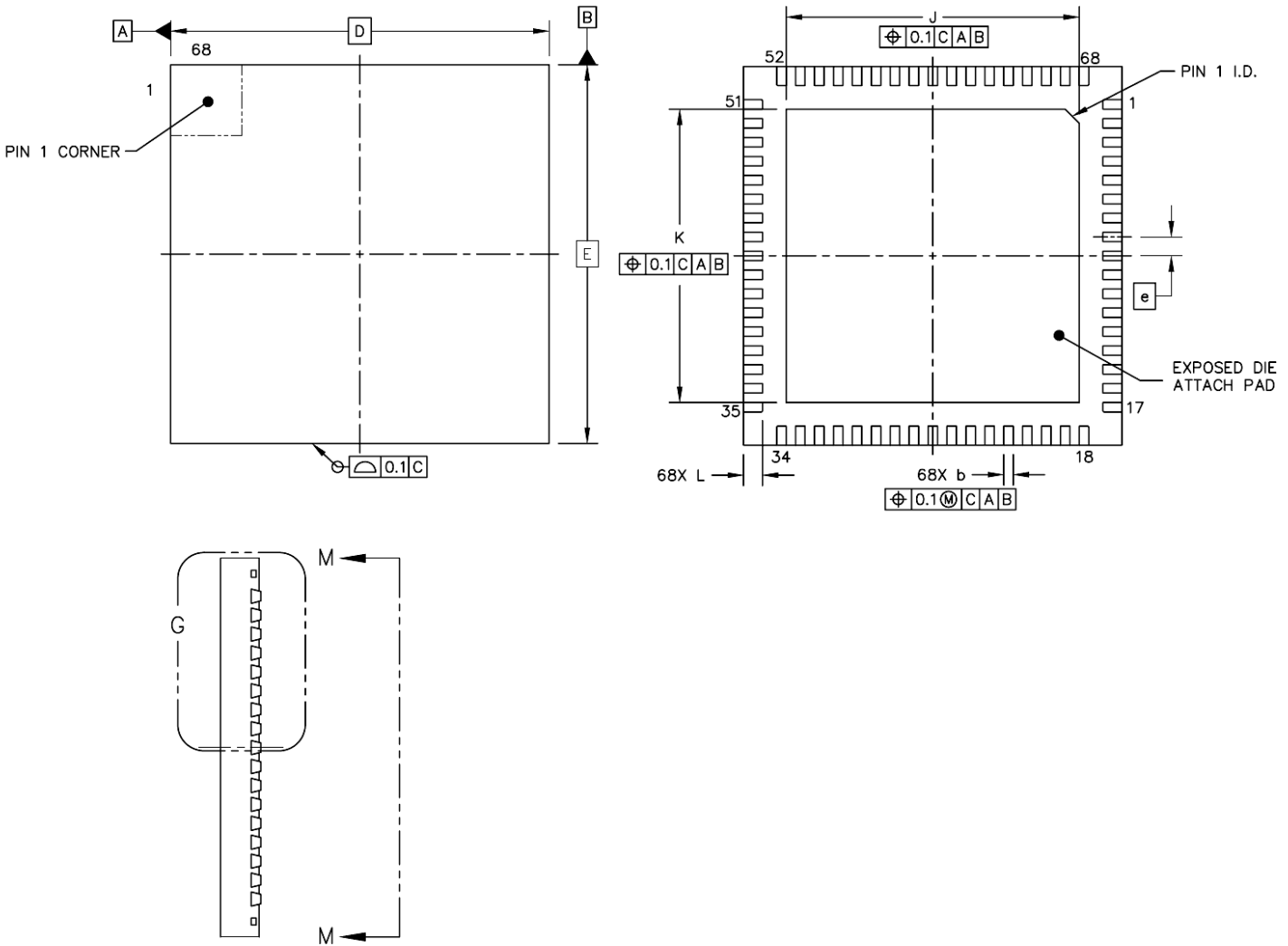

		SYMBOL	MIN	NOM	MAX
TOTAL THICKNESS		A	0.8	0.85	0.9
STAND OFF		A1	0	0.035	0.05
MOLD THICKNESS		A2	---	0.65	0.67
L/F THICKNESS		A3	0.203 REF		
LEAD WIDTH		b	0.15	0.20	0.25
BODY SIZE	X	D	8 BSC		
	Y	E	8 BSC		
LEAD PITCH		e	0.4 BSC		
EP SIZE	X	J	6.1	6.2	6.3
	Y	K	6.1	6.2	6.3
LEAD LENGTH		L	0.35	0.4	0.45
PACKAGE EDGE TOLERANCE		aaa	0.1		
MOLD FLATNESS		bbb	0.1		
COPLANARITY		ccc	0.08		
LEAD OFFSET		ddd	0.1		
EXPOSED PAD OFFSET		eee	0.1		

16.2 QFN 48 pins (6x6mm)

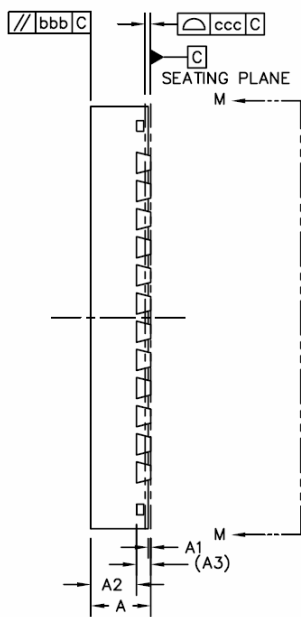
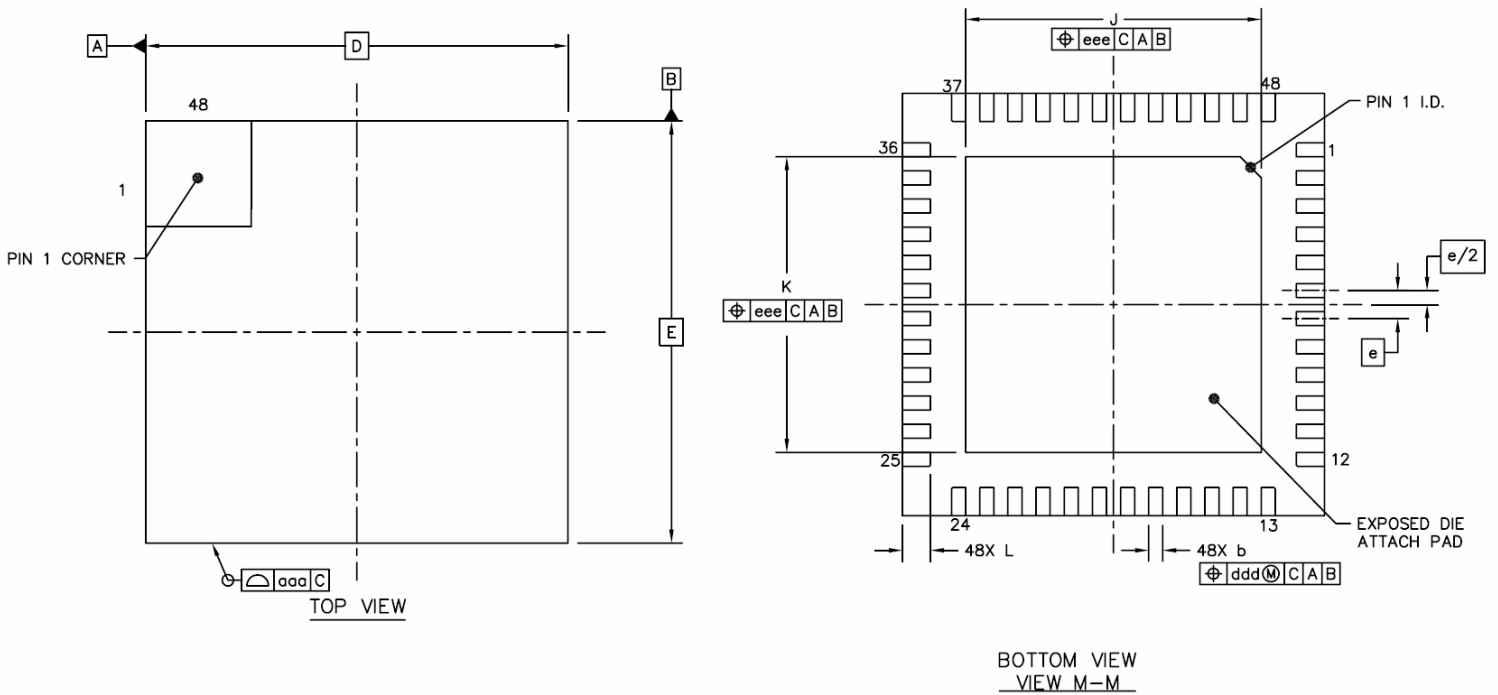

		SYMBOL	MIN	NOM	MAX
TOTAL THICKNESS		A	0.8	0.85	0.9
STAND OFF		A1	0	0.035	0.05
MOLD THICKNESS		A2	---	0.65	0.67
L/F THICKNESS		A3	0.203 REF		
LEAD WIDTH		b	0.15	0.2	0.25
BODY SIZE	X	D	6 BSC		
	Y	E	6 BSC		
LEAD PITCH		e	0.4 BSC		
EP SIZE	X	J	4.1	4.2	4.3
	Y	K	4.1	4.2	4.3
LEAD LENGTH		L	0.35	0.4	0.45
PACKAGE EDGE TOLERANCE		aaa	0.1		
MOLD FLATNESS		bbb	0.1		
COPLANARITY		ccc	0.08		
LEAD OFFSET		ddd	0.1		
EXPOSED PAD OFFSET		eee	0.1		

16.3 QFN 40 pins (5x5mm)

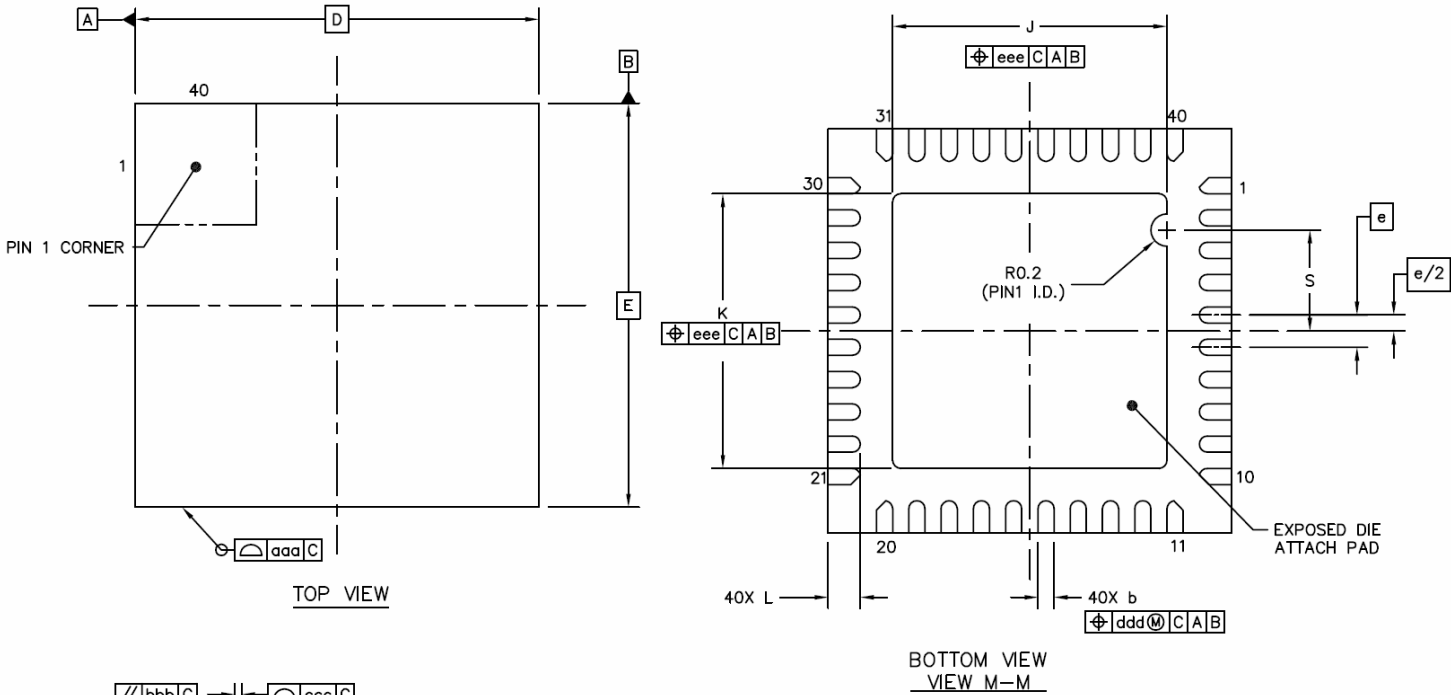

	SYMBOL	MIN	NOM	MAX	
TOTAL THICKNESS	A	0.5	0.55	0.6	
STAND OFF	A1	0	0.035	0.05	
MOLD THICKNESS	A2	---	0.4	0.425	
L/F THICKNESS	A3	0.152 REF			
LEAD WIDTH	b	0.15	0.2	0.25	
BODY SIZE	X	D	5 BSC		
	Y	E	5 BSC		
LEAD PITCH	e	0.4 BSC			
EP SIZE	X	J	3.3	3.4	3.5
	Y	K	3.3	3.4	3.5
LEAD LENGTH	L	0.35	0.4	0.45	
	S	1.15	1.25	1.35	
PACKAGE EDGE TOLERANCE	aaa	0.1			
MOLD FLATNESS	bbb	0.1			
COPLANARITY	ccc	0.08			
LEAD OFFSET	ddd	0.1			
EXPOSED PAD OFFSET	eee	0.1			

16.4 Package orientation

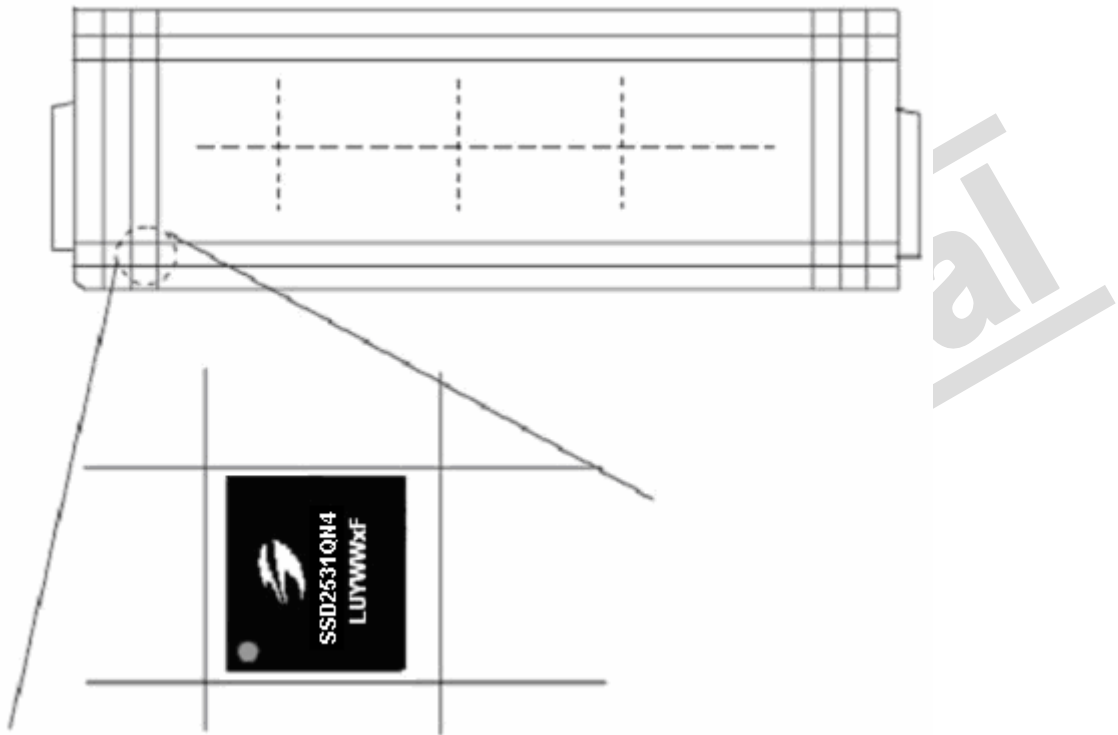

Figure 16-1 : SSD2531QN4 package orientation

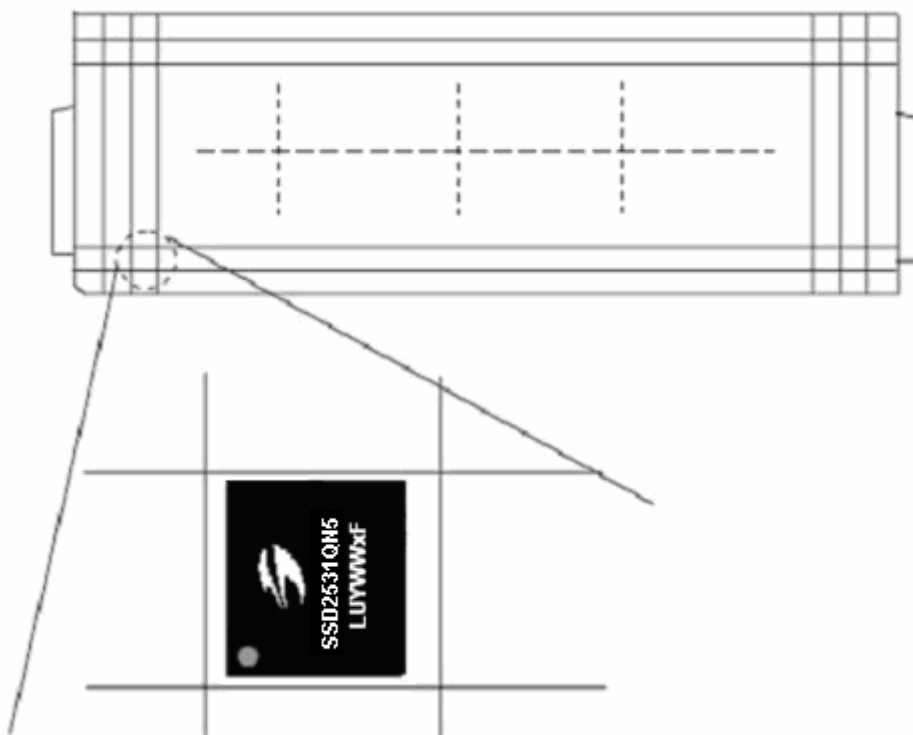

Figure 16-2 : SSD2531QN5 package orientation

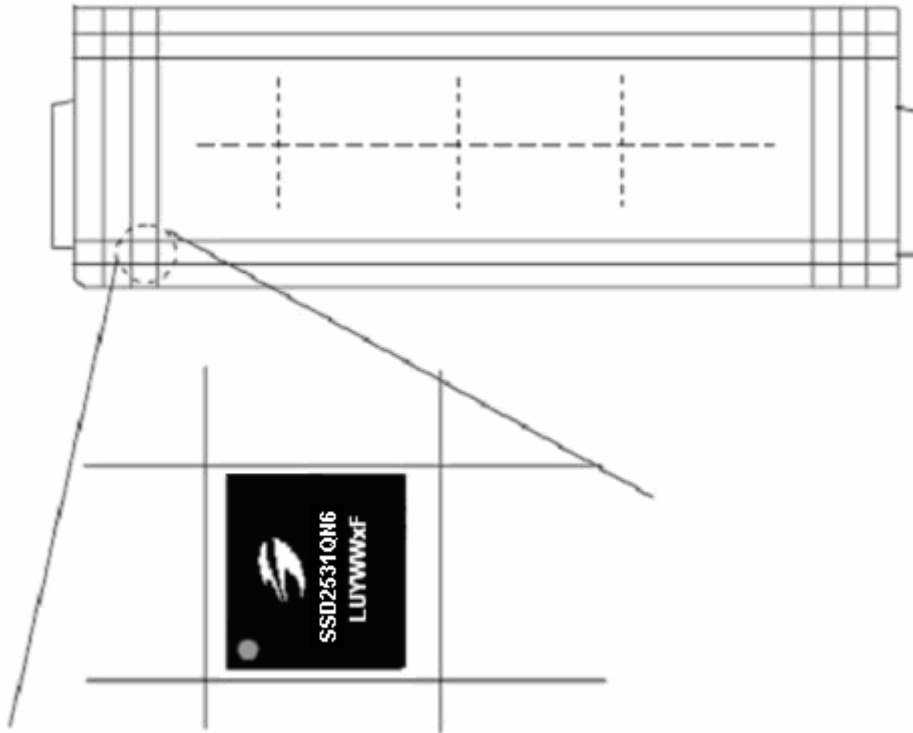

Figure 16-3 : SSD2531QN6 package orientation

Confidential

Solomon Systech reserves the right to make changes without notice to any products herein. Solomon Systech makes no warranty, representation or guarantee regarding the suitability of its products for any particular purpose, nor does Solomon Systech assume any liability arising out of the application or use of any product or circuit, and specifically disclaims any, and all, liability, including without limitation consequential or incidental damages. "Typical" parameters can and do vary in different applications. All operating parameters, including "Typical" must be validated for each customer application by the customer's technical experts. Solomon Systech does not convey any license under its patent rights nor the rights of others. Solomon Systech products are not designed, intended, or authorized for use as components in systems intended for surgical implant into the body, or other applications intended to support or sustain life, or for any other application in which the failure of the Solomon Systech product could create a situation where personal injury or death may occur. Should Buyer purchase or use Solomon Systech products for any such unintended or unauthorized application, Buyer shall indemnify and hold Solomon Systech and its offices, employees, subsidiaries, affiliates, and distributors harmless against all claims, costs, damages, and expenses, and reasonable attorney fees arising out of, directly or indirectly, any claim of personal injury or death associated with such unintended or unauthorized use, even if such claim alleges that Solomon Systech was negligent regarding the design or manufacture of the part.



The product(s) listed in this datasheet comply with Directive 2002/95/EC of the European Parliament and of the council of 27 January 2004 on the restriction of the use of certain hazardous substances in electrical and electronic equipment and People's Republic of China Electronic Industry Standard SJ/T 11363-2006 "Requirements for concentration limits for certain hazardous substances in electronic information products (电子信息产品中有毒有害物质的限量要求)". Hazardous Substances test report is available upon request.

<http://www.solomon-systech.com>