

# 2SA1859/1859A

Silicon PNP Epitaxial Planar Transistor (Complement to type 2SC4883/A)

Application : Audio Output Driver and TV Velocity-modulation

**Absolute maximum ratings** (Ta=25°C)

Symbol	2SA1859	2SA1859A	Unit
V <sub>CBO</sub>	-150	-180	V
V <sub>CEO</sub>	-150	-180	V
V <sub>EB0</sub>	-6		V
I <sub>C</sub>	-2		A
I <sub>B</sub>	-1		A
P <sub>C</sub>	20(Tc=25°C)		W
T <sub>j</sub>	150		°C
T <sub>stg</sub>	-55 to +150		°C

**Electrical Characteristics** (Ta=25°C)

Symbol	Conditions	2SA1859	2SA1859A	Unit
I <sub>CBO</sub>	V <sub>CB</sub> =	-10max		μA
V <sub>CEO</sub>	V <sub>CB</sub> =	-150	-180	V
I <sub>EB0</sub>	V <sub>EB</sub> =-6V	-10max		μA
V <sub>(BR)CEO</sub>	I <sub>C</sub> =-10mA	-150min	-180min	V
h <sub>FE</sub>	V <sub>CE</sub> =-10V, I <sub>C</sub> =-0.7A	60 to 240		
V <sub>CE(sat)</sub>	I <sub>C</sub> =-0.7A, I <sub>B</sub> =-70mA	-1.0max		V
f <sub>r</sub>	V <sub>CE</sub> =-12V, I <sub>E</sub> =0.7A	60typ		MHz
COB	V <sub>CB</sub> =-10V, f=1MHz	30typ		pF

**Typical Switching Characteristics (Common Emitter)**

V <sub>CC</sub> (V)	R <sub>L</sub> (Ω)	I <sub>C</sub> (A)	V <sub>BB1</sub> (V)	V <sub>BB2</sub> (V)	I <sub>B1</sub> (mA)	I <sub>B2</sub> (mA)	t <sub>on</sub> (μs)	t <sub>stg</sub> (μs)	t <sub>f</sub> (μs)
-20	20	-1	-10	5	-100	100	0.5typ	1.0typ	0.5typ

**External Dimensions FM20(TO220F)**

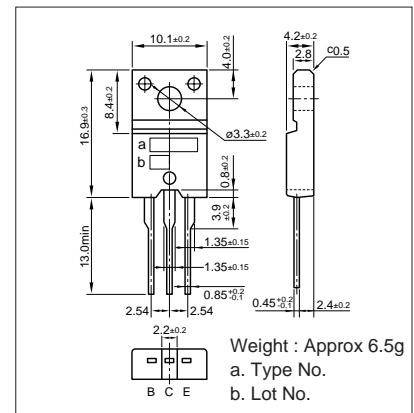

**I<sub>C</sub>-V<sub>CE</sub> Characteristics (Typical)**

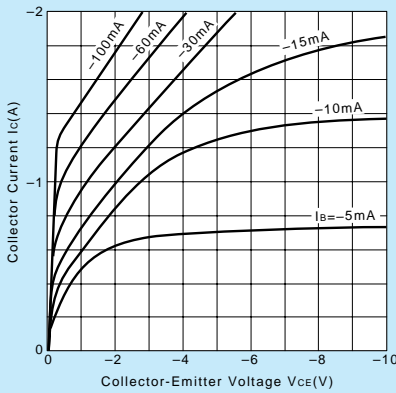

**V<sub>CE(sat)</sub>-I<sub>B</sub> Characteristics (Typical)**

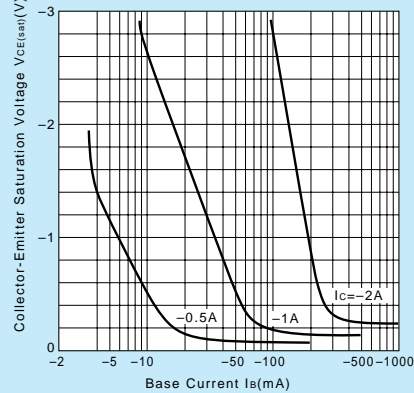

**I<sub>C</sub>-V<sub>BE</sub> Temperature Characteristics (Typical)**

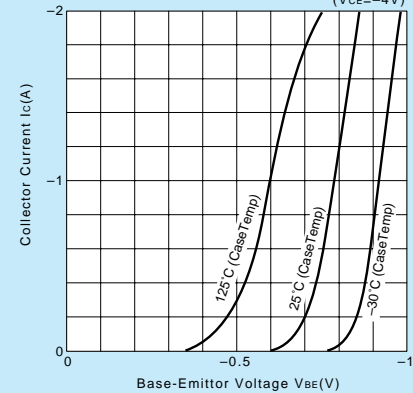

**h<sub>FE</sub>-I<sub>C</sub> Characteristics (Typical)**

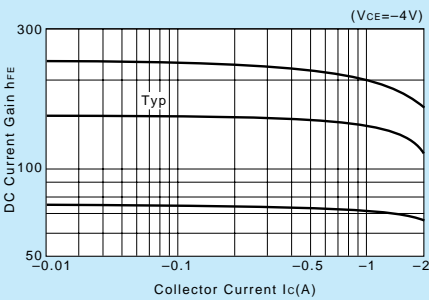

**h<sub>FE</sub>-I<sub>C</sub> Temperature Characteristics (Typical)**

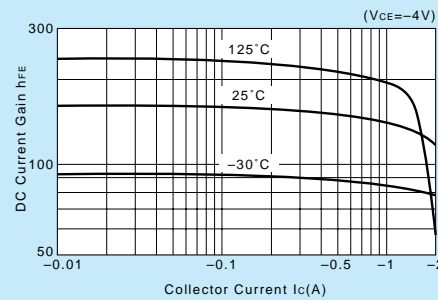

**θ<sub>j-a</sub>-t Characteristics**

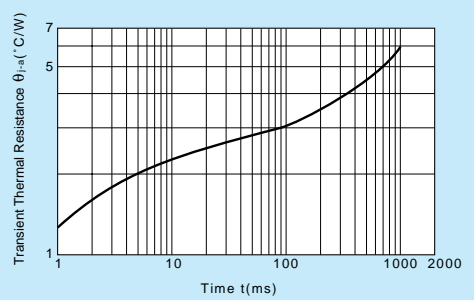

**f<sub>r</sub>-I<sub>E</sub> Characteristics (Typical)**

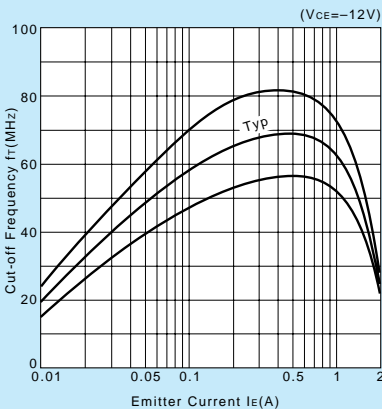

**Safe Operating Area (Single Pulse)**

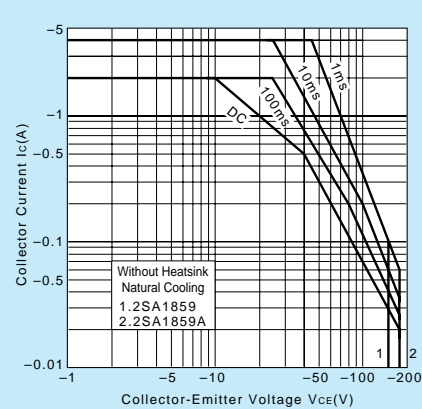

**P<sub>C</sub>-T<sub>a</sub> Derating**

