



**800mA Low Dropout Regulator
SCSI-II Active Terminator**

FEATURES

- Guaranteed 800mA Output
- Three Terminal Adjustable Or Fixed 1.5V, 2.5V, 2.85V, 3V, 3.3V & 5V
- Very Low Quiescent Current
- Low Dropout Voltage Of 1.2 Volts At Full Load
- Extremely Tight Load And Line Regulation
- Very Low Temperature Coefficient
- Fixed 2.85V Device For SCSI-II Active Terminator
- Logic-Controlled Electronic Shutdown
- Internal Overcurrent Limiting & Thermal Overload Protection
- Surface Mount Package SOT-223, TO-252, TO-220, SOT-89, TO-263, & SO-8

APPLICATIONS

- SCSI-II Active Terminator
- Portable/ Palm Top / Notebook Computers
- Battery Chargers
- Disk Drives
- Portable Consumer Equipment
- Portable Instrumentation
- SMPS Post-Regulator

PRODUCT DESCRIPTION

The ALPHA Semiconductor AS1117 is a low power positive-voltage regulator designed to meet 800mA output current and comply with SCSI-II specifications with a fixed output voltage of 2.85V. This device is an excellent choice for use in battery-powered applications, as active terminators for the SCSI bus, and portable computers. The AS1117 features very low quiescent current and very low dropout voltage of 1.2V at a full load and lower as output current decreases. AS1117 is available as an adjustable or fixed 2.85V, 3V, 3.3V, and 5V output voltages.

The AS1117 is offered in a 3-pin surface mount package SOT-223, TO-252, TO-220, SOT-89 & TO-263. The output capacitor of 10µF or larger is needed for output stability of AS1117 as required by most of the other regulator circuits. Use of ALPHA Semiconductor's design, processing and testing techniques make our AS1117 superior over similar products.

ORDERING INFORMATION

TO-220 3-PIN	TO-263 3-PIN	SOT-223 3-PIN	PLASTIC SOIC 8 PIN	SOT-89 3-PIN	TO-252 DPAK	Oper. Temp. Range
AS1117U	AS1117T	AS1117M3	AS1117S	AS1117M1	AS1117R	-40°C to +85°C
AS1117U-X	AS1117T-X	AS1117M3-X	AS1117S-X	AS1117M1-X	AS1117R-X	-40°C to +85°C

X= Output Voltage (X = 1.5V, 2.5V, 2.85V, 3.0V, 3.3V, 5.0, or Blank for Adjustable)

PIN CONNECTIONS

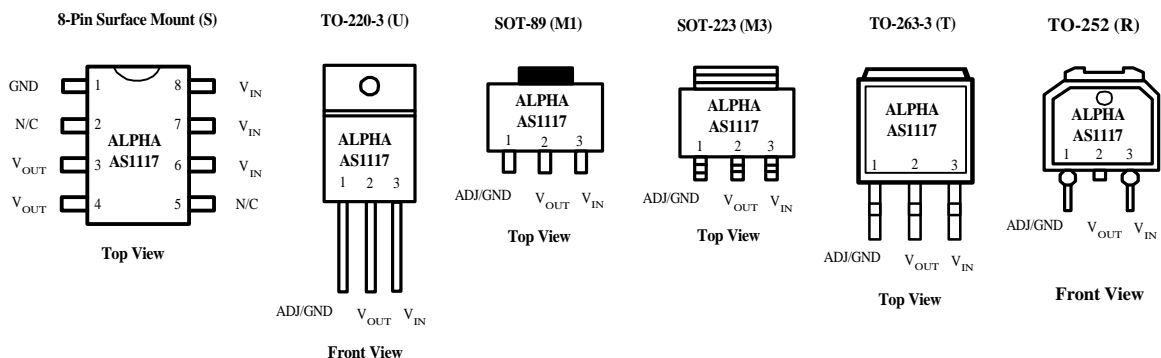

ABSOLUTE MAXIMUM RATINGS

Power Dissipation.....	Internally Limited
Lead Temp. (Soldering, 5 Seconds)	260°C
Storage Temperature Range	-65° to +150°C
Operating Junction Temperature Range	
AS1117	-40°C to +125°C

Input Supply Voltage.....	-20V to +20V
ESD Rating	2KV Min

ELECTRICAL CHARACTERISTICS at $V_{IN} = V_{OUT} + 1$, $T_a = 25^\circ\text{C}$, $C_L = 3.3\mu\text{f}$, unless otherwise specified. Limits in **Boldface** apply over the full operating temperature range.

Parameter	Conditions	Typ	AS1117		Units
			Min	Max	
1.5V Version					
Output Voltage	$I_{OUT} = 10\text{mA}$, $V_{IN} = 4.85\text{V}$ $0 \leq I_{OUT} \leq 800\text{mA}$, $4.25 \leq V_{IN} \leq 10\text{V}$	1.500	1.485 1.470	1.515 1.530	V
2.5V Version					
Output Voltage	$I_{OUT} = 10\text{mA}$, $V_{IN} = 4.85\text{V}$ $0 \leq I_{OUT} \leq 800\text{mA}$, $4.25 \leq V_{IN} \leq 10\text{V}$	2.500	2.475 2.450	2.525 2.550	V
2.85V Version					
Output Voltage	$I_{OUT} = 10\text{mA}$, $V_{IN} = 4.85\text{V}$ $0 \leq I_{OUT} \leq 800\text{mA}$, $4.25 \leq V_{IN} \leq 10\text{V}$	2.850	2.822 2.793	2.879 2.907	V
3.0V Version					
Output Voltage	$I_{OUT} = 10\text{mA}$, $V_{IN} = 4.85\text{V}$ $0 \leq I_{OUT} \leq 800\text{mA}$, $4.75 \leq V_{IN} \leq 10\text{V}$	3.000	2.970 2.940	3.030 3.060	V
3.3V Version					
Output Voltage	$I_{OUT} = 10\text{mA}$, $V_{IN} = 5.0\text{V}$ $0 \leq I_{OUT} \leq 800\text{mA}$, $4.75 \leq V_{IN} \leq 10\text{V}$	3.300	3.267 3.234	3.333 3.366	V
5.0V Version					
Output Voltage	$I_{OUT} = 10\text{mA}$, $V_{IN} = 7.0\text{V}$ $0 \leq I_{OUT} \leq 800\text{mA}$, $6.50 \leq V_{IN} \leq 12\text{V}$	5.000	4.950 4.900	5.050 5.100	V
All Output Options					
Reference Voltage	$I_{OUT} = 10\text{mA}$, $(V_{IN} - V_{OUT}) = 2\text{V}$ $10 \leq I_{OUT} \leq 800\text{mA}$, $1.4 \leq (V_{IN} - V_{OUT}) \leq 10\text{V}$	1.250	1.238 1.225	1.262 1.270	V
Output Voltage Temperature Stability	(Note 1)			0.05	%
Line Regulation	$4.25\text{V} \leq V_{IN} \leq 10\text{V}$, $V_{OUT} = 2.85$, $I_{OUT} = 0$ $4.50\text{V} \leq V_{IN} \leq 12\text{V}$, $V_{OUT} = 3.00$, $I_{OUT} = 0$ $4.80\text{V} \leq V_{IN} \leq 12\text{V}$, $V_{OUT} = 3.30$, $I_{OUT} = 0$ $6.50\text{V} \leq V_{IN} \leq 15\text{V}$, $V_{OUT} = 5.00$, $I_{OUT} = 0$	1.00 1.00 1.00 1.00		6.00 7.00 7.00 10.00	mV
Load Regulation	$0 \leq I_{OUT} \leq 800\text{mA}$, $V_{IN} = 4.25\text{V}$, $V_{OUT} = 2.85$ $0 \leq I_{OUT} \leq 800\text{mA}$, $V_{IN} = 4.50\text{V}$, $V_{OUT} = 3.00$ $0 \leq I_{OUT} \leq 800\text{mA}$, $V_{IN} = 4.80\text{V}$, $V_{OUT} = 3.30$ $0 \leq I_{OUT} \leq 800\text{mA}$, $V_{IN} = 6.50\text{V}$, $V_{OUT} = 5.00$	1.00 1.00 1.00 1.00		10.00 12.00 12.00 15.00	mV
Dropout Voltage (Note 2)	$I_L = 100\text{mA}$ $I_L = 500\text{mA}$ $I_L = 800\text{mA}$	1.00 1.05 1.10		1.10 1.15 1.20	V
Quiescent Current	$4.25\text{V} \leq V_{IN} \leq 6.5\text{V}$	5.00		10.00	mA
Current Limit	$(V_{IN} - V_{OUT}) = 5\text{V}$	1000		1200	mA
Thermal Regulation	25°C, 30mS Pulse	0.01		0.1	%/W
Ripple Rejection	$f_{RIPPLE} = 120\text{Hz}$, $(V_{in} - V_{OUT}) = 3\text{V}$, $V_{RIPPLE} = 1\text{V}_{p-p}$	60		75	dB
Long Term Stability	125°C, 1000Hrs			0.03	%
RMS Output Noise	% of V_{out} , $10\text{Hz} \leq f \leq 10\text{kHz}$			0.003	%
Thermal Resistance	Junction to case, at tab			15	°C/W°

Note 1: Output temperature coefficient is defined as the worst case voltage change divided by the total temperature range

Note 2: Dropout voltage is defined as the input to output differential at which the output voltage drops 100mV below its nominal value measured at 1V differential at very low values of programmed output voltage, the minimum input supply voltage of 2V (2.3V over temperature) must be taken into account.

Note 3: Thermal regulation is defined as the change in output voltage at a time T after a change in power dissipation is applied. excluding load or line regulation effect.

APPLICATION NOTES EXTERNAL CAPACITOR

To ensure the stability of the AS1117 an output capacitor of at least 10 μ F (tantalum) or 50 μ F (aluminum) is required. The value may change based on the application requirements on the output load or temperature range. The capacitor equivalent series resistance (ESR) will effect the AS1117 stability. The value of ESR can vary from the type of capacitor used in the applications. The recommended value for ESR is 0.5 Ω . The output capacitance could increase in size to above the minimum value. The larger value of output capacitance as high as 100 μ F can improve the load transient response.

SOLDERING METHODS

The AS1117 SOT-223 package is designed to be compatible with infrared reflow or vapor-phase reflow soldering techniques. During soldering the non-active or mildly active fluxes may be used. The AS1117 die is attached to the heatsink lead which exits opposite the input, output, and ground pins.

Hand soldering and wave soldering should be avoided since these methods can cause damage to the device with excessive thermal gradients on the package. The SOT-223 recommended soldering method are as follows: vapor phase reflow and infrared reflow with the component preheated to within 65 $^{\circ}$ C of the soldering temperature range.

THERMAL CHARACTERISTICS

The thermal resistance of AS1117 is 15 $^{\circ}$ C/W from junction to tab and 31 $^{\circ}$ C/W from tab to ambient for a total of 46 $^{\circ}$ C/W from junction to ambient. The AS1117 features the internal thermal limiting to protect the device during overload conditions. Special care needs to be taken during continuous load conditions the maximum junction temperature does not exceed 125 $^{\circ}$ C.

Taking the FR-4 printed circuit board and 1/16 thick with 1 ounce copper foil as an experiment (fig.1 & fig.2), the PCB material is effective at transmitting heat with the tab attached to the pad area and a ground plane layer on the backside of the substrate. Refer to table 1 for the results of the experiment.

The thermal interaction from other components in the application can effect the thermal resistance of the AS1117. The actual thermal resistance can be determined with experimentation. AS1117 power dissipation is calculated as follows:

$$P_D = (V_{IN} - V_{OUT})(I_{OUT})$$

Maximum Junction Temperature range:

$$T_J = T_{\text{ambient (max)}} + P_D * \text{thermal resistance (Junction-to-ambient)}$$

Maximum Junction temperature must not exceed the 125 $^{\circ}$ C.

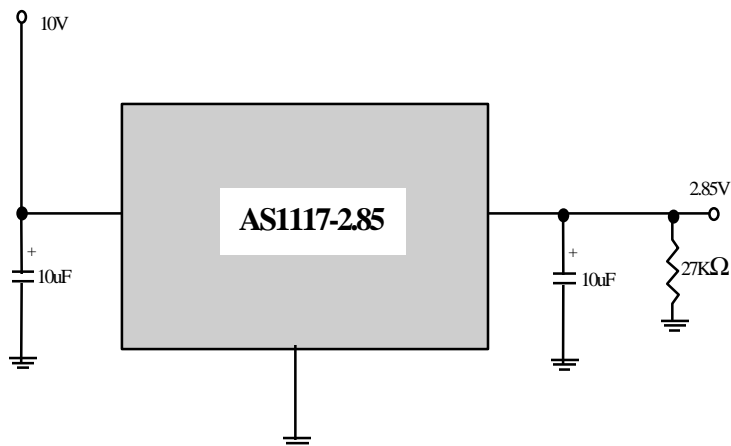

$$P_o = (10V - 2.85)(105mA) = (7.15)(105mA) = 750mW$$

Fig. 1. Circuit Layout, Thermal Experiments.

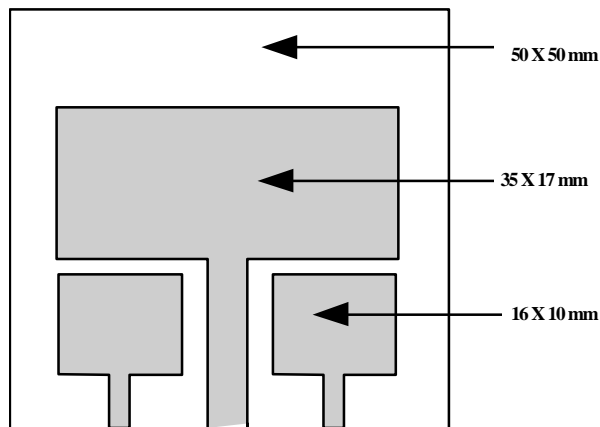
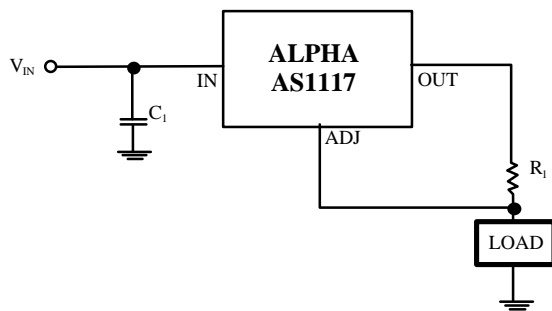

Fig. 2. Substrate Layout for SOT-223

Table 1.

TOTAL PC BOARD AREA	TOPSIDE COPPER AREA	BACKSIDE COPPER AREA	THERMAL RESISTANCE JUNCTION TO AMBIENT
2500mm	2500mm	2500mm	46°C/W°
2500mm	1250mm	2500mm	47°C/W°
2500mm	950mm	2500mm	49°C/W°
2500mm	2500mm	0	51°C/W°
2500mm	1800mm	0	53°C/W°
1600mm	600mm	1600mm	55°C/W°
2500mm	1250mm	0	58°C/W°
2500mm	915mm	0	59°C/W°
1600mm	600mm	0	67°C/W°
900mm	240mm	900mm	72°C/W°
900mm	240mm	0	85°C/W°



800mA Current output

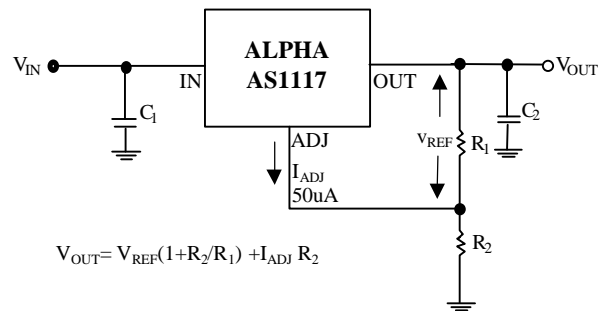

$$V_{OUT} = V_{REF}(1 + R_2/R_1) + I_{ADJ} R_2$$

Typical Adjustable Regulator

PACKAGE DRAWING TO-263-3L (T)

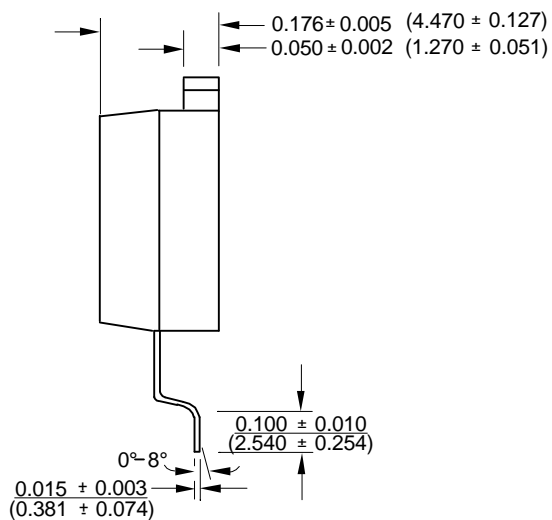
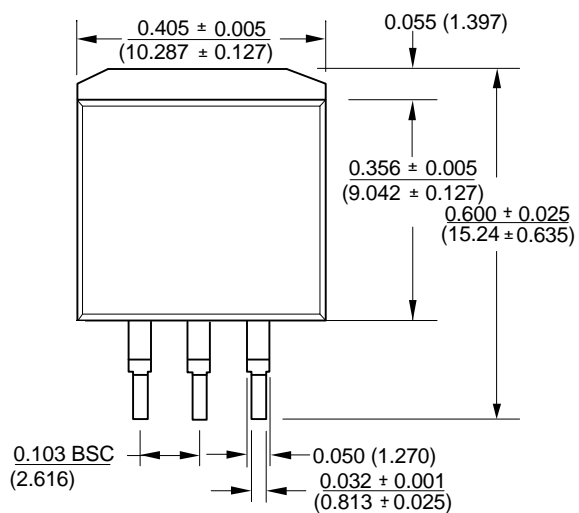

PACKAGE DRAWING
SOT-223-3L (M3)

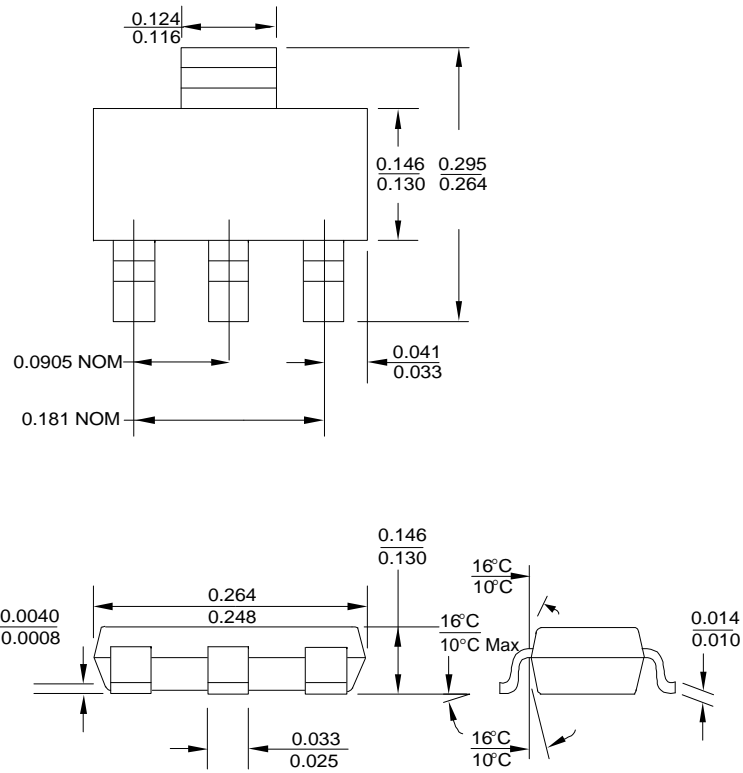

PACKAGE DRAWING TO-220-3L (U)

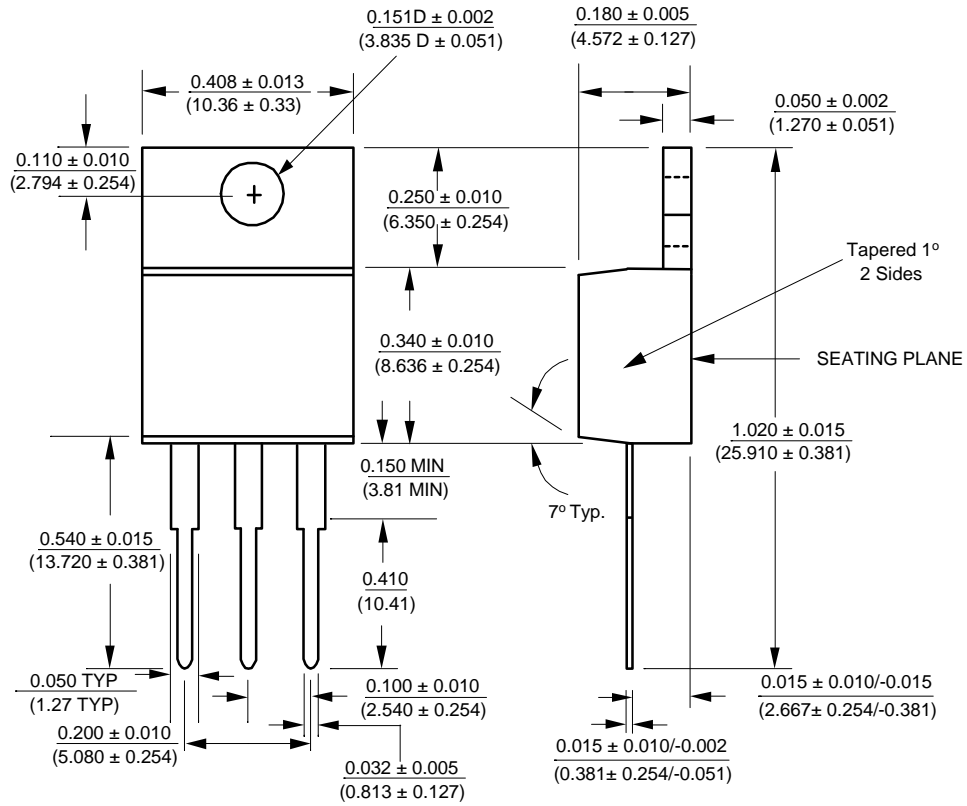

PACKAGE DRAWING 8-PIN SOIC (S)

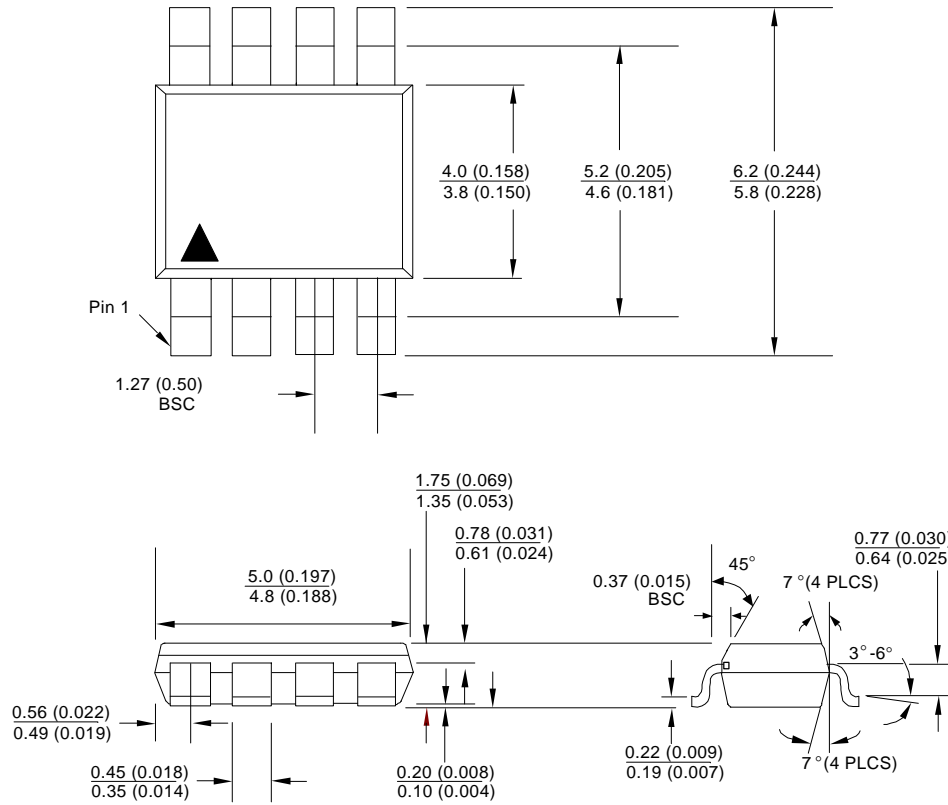

PACKAGE DRAWING SOT-89 (M1)

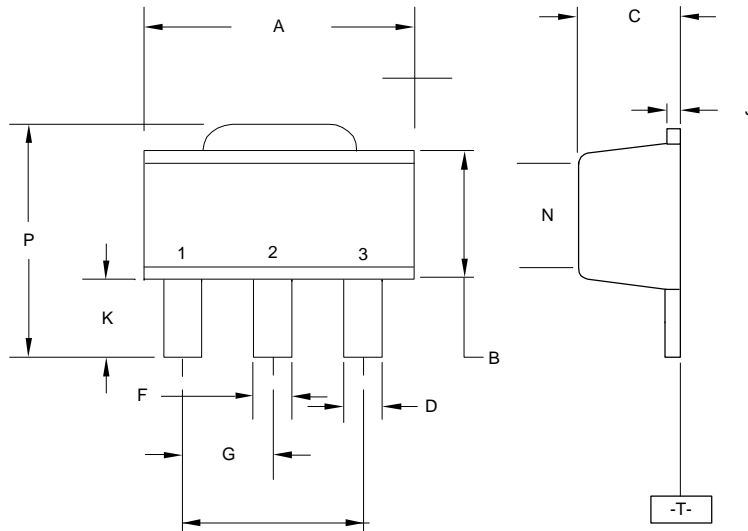

- | | |
|---|--|
| <p>STYLE 1
PIN 1. BASE
2. COLLECTOR
3. EMITTER</p> | <p>STYLE 3
PIN 1. GATE
2. ANODE
3. CATHODE</p> |
| <p>STYLE 2
PIN 1. ANODE
2. CATHODE
3. NO CONNECTION</p> | <p>STYLE 4
PIN 1. DRAIN
2. GATE
3. SOURCE</p> |

DIM	MILLIMETERS		INCHES	
	MIN	MAX	MIN	MAX
A	4.40	4.60	0.174	0.181
B	2.29	2.60	0.091	0.102
C	140	160	0.056	0.062
D	0.36	0.48	0.015	0.018
E	1.62	1.80	0.064	0.070
F	0.44	0.53	0.018	0.020
G	150 BSC		0.059 BSC	
J	0.35	0.44	0.014	0.017
K	0.80	1.04	0.032	0.040
L	300 BSC		0.118 BSC	
N	2.04	2.28	0.081	0.089
P	3.94	4.25	0.156	0.167

PACKAGE DRAWING TO-252-3L (R)

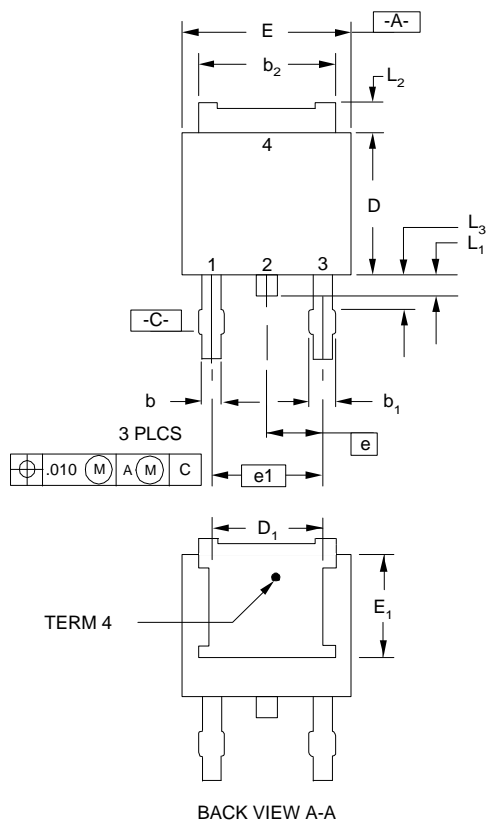

NOTES

1. Refer To Applicable Symbol List.
2. Dimensions And Tolerancing Per Ansi Y14.5m - 1982.
3. Lead Dimension Uncontrolled In L₃.
4. Tab Contour Optional Within Dim. b₂ & L₂ And E₁ & D₁
 5. D₁ & E₁ Establishes A Minimum Mounting Surface for Terminal 4.
6. L is the Termal Length for Soldering.
7. Controlling Dimension: Inch
8. 2 Mils Suggested For Postive Contact At Mounting.

SYMBOL	INCHES		MM		NOTE
	MIN	MAX	MIN	MAX	
L					
A	0.086	0.094	2.184	2.3876	
A1	0.035	0.045	0.889	1.143	
b	0.025	0.035	0.635	0.889	
b1	0.300	0.045	7.620	1.143	
b2	0.205	0.215	5.207	5.461	4
c	0.018	0.023	0.457	0.5842	
c1	0.018	0.023	0.457	0.5842	
D	0.235	0.245	5.969	6.223	
D1	0.170	-	4.318	-	4,5
E	0.250	0.265	6.350	6.731	
E1	0.170	-	4.318	-	4,5
e	0.098		2.489		
e1	0.180		4.572		
H	0.370	0.410	9.398	10.414	
L	0.020	-	0.508	-	6
L1	0.025	0.040	0.635	1.016	
L2	0.035	0.050	0.889	1.270	4
L3	0.045	0.060	1.143	1.524	3

ADVANCE INFORMATION- These data sheets contain descriptions of products that are in development. The specifications are based on the engineering calculations, computer simulations and/ or initial prototype evaluation.

PRELIMINARY INFORMATION- These data sheets contain minimum and maximum specifications that are based on the initial device characterizations. These limits are subject to change upon the completion of the full characterization over the specified temperature and supply voltage ranges.

The information provided here is believed to be reliable and accurate, however ALPHA assumes no responsibility for its use. ALPHA makes no guarantee for any errors that appear in this document. "Typical" parameters can and do vary in different applications. All operating parameters, including "Typical" must be validated for each customer application by customer's technical experts. Specifications are subject to change without notice, contact ALPHA in order to obtain the latest version of the device specification sheet before using any ALPHA devices. ALPHA is not responsible for any defects that occur in equipment using any ALPHA devices. ALPHA makes no representation that the circuit descriptions herein will not infringe upon existing patent rights.

ALPHA Semiconductor, Inc.
1031 Serpentine Lane
Pleasanton, CA 94566 USA
Tel: (925) 417-1391 Fax: (925) 417-1390
e-mail: alphasem@best.com
web: www.alpha-semi.com

ALPHA Semiconductor-Taiwan
12F, No. 171, Sun Teh Road
Taipei, Taiwan
Tel: 886-2-27281190 Fax: 886-2-27591822
e-mail: alphasemi@ms14.hinet.net

LIFE SUPPORT APPLICATION POLICY: ALPHA Semiconductor products are not authorized for use as critical components in life support devices or systems, nuclear power, aircraft, or space equipment without express written approval from the president of ALPHA Semiconductor.