

## SSM-2220

### FEATURES

- **Very Low Voltage Noise** ..... @ 100Hz,  $1\text{nV}/\sqrt{\text{Hz}}$  Max
- **High Gain Bandwidth** ..... 190MHz Typ
- **Excellent Gain** ..... @  $I_C = 1\text{mA}$ , 165 Typ
- **Tight Gain Matching** ..... 3% Max
- **Outstanding Logarithmic Conformance**...  $r_{BE} = 0.3\Omega$  Typ
- **Low Offset Voltage** ..... 200 $\mu\text{V}$  Max
- **Low Cost**

### APPLICATIONS

- **Microphone Preamplifiers**
- **Tape-Head Preamplifiers**
- **Current Sources and Mirrors**
- **Low Noise Precision Instrumentation**
- **Voltage Controlled Amplifiers/Multipliers**

### ORDERING INFORMATION

| 8-PIN EPOXY DIP | 8-PIN SO* | OPERATING<br>TEMPERATURE<br>RANGE |
|-----------------|-----------|-----------------------------------|
| SSM2220P        | SSM2220S  | -40°C to +85°C                    |

\* For availability of SO package, contact your local sales office.

### GENERAL DESCRIPTION

The SSM-2220 is a dual low noise matched PNP transistor which has been optimized for use in audio applications.

The ultra-low input voltage noise of the SSM-2220 is typically only  $0.7\text{nV}/\sqrt{\text{Hz}}$  over the entire audio bandwidth of 20Hz to 20kHz. The low noise, high bandwidth (190MHz), and Offset Voltage of (200 $\mu\text{V}$  Max) make the SSM-2220 an ideal choice for demanding low noise preamplifier applications.

The SSM-2220 also offers excellent matching of the current gain ( $\Delta h_{FE}$ ) to about 0.5% which will help to reduce the high order amplifier harmonic distortion. In addition, to insure the long-term stability of the matching parameters, internal protection diodes across the base-emitter junction were used to clamp any reverse base-emitter junction potential. This prevents a base-emitter breakdown condition which can result in degradation of gain and matching performance due to excessive breakdown current.

Another feature of the SSM-2220 is its very low bulk resistance of  $0.3\Omega$  typically which assures accurate logarithmic conformance.

The SSM-2220 is offered in 8-pin plastic, dual-in-line, and SO and its performance and characteristics are guaranteed over the extended industrial temperature range of -40°C to +85°C.

### PIN CONNECTIONS

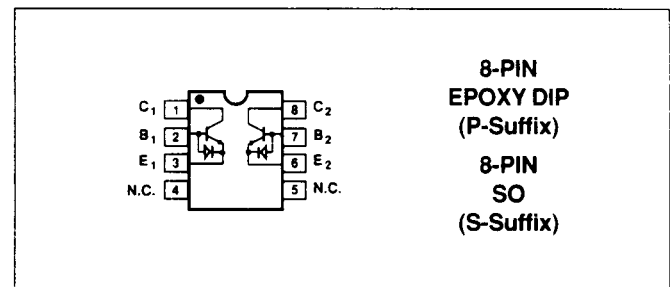

# SSM-2220

## ABSOLUTE MAXIMUM RATINGS

|  |                 |
|--|-----------------|
| Collector-Base Voltage ( $V_{CB0}$ )     | 36V             |
| Collector-Emitter Voltage ( $V_{CEO}$ )  | 36V             |
| Collector-Collector Voltage ( $V_{CC}$ ) | 36V             |
| Emitter-Emitter Voltage ( $V_{EE}$ )     | 36V             |
| Collector Current ( $I_C$ )              | 20mA            |
| Emitter Current ( $I_E$ )                | 20mA            |
| Operating Temperature Range              |                 |
| SSM-2220P                                | -40°C to +85°C  |
| SSM-2220S                                | -40°C to +85°C  |
| Operating Junction Temperature           | -55°C to +150°C |

|                                      |                 |
|--------------------------------------|-----------------|
| Storage Temperature                  | -65°C to +150°C |
| Lead Temperature (Soldering, 60 sec) | +300°C          |
| Junction Temperature                 | -65°C to +150°C |

| PACKAGE TYPE          | $\theta_{JA}$ (Note 1) | $\theta_{JC}$ | UNITS |
|-----------------------|------------------------|---------------|-------|
| 8-Pin Plastic DIP (P) | 103                    | 43            | °C/W  |
| 8-Pin SO (S)          | 158                    | 43            | °C/W  |

### NOTE:

- $\theta_{JA}$  is specified for worst case mounting conditions, i.e.,  $\theta_{JA}$  is specified for device in socket for P-DIP package;  $\theta_{JA}$  is specified for device soldered to printed circuit board for SO packages.

## ELECTRICAL CHARACTERISTICS at $T_A = +25^\circ\text{C}$ , unless otherwise noted.

| PARAMETER                                      | SYMBOL                        | CONDITIONS   | SSM-2220 |       |      | UNITS          |
|--|-------------------------------|--|----------|-------|------|----------------|
|  |                               |  | MIN      | TYP   | MAX  |                |
| Current Gain<br>(Note 1)                       | $h_{FE}$                      | $V_{CB} = 0V, -36V$                                    | 80       | 165   | -    |                |
|  |                               | $I_C = 1mA$  | 70       | 150   | -    |                |
|  |                               | $I_C = 100\mu A$                                       | 60       | 120   | -    |                |
| Current Gain Matching<br>(Note 2)              | $\Delta h_{FE}$               | $I_C = 100\mu A, V_{CB} = 0V$                          | -        | 0.5   | 6    | %              |
| Noise Voltage Density<br>(Note 3)              | $e_N$                         | $I_C = 1mA, V_{CB} = 0V$                               | -        | 0.8   | 2    | $nV/\sqrt{Hz}$ |
|  |                               | $f_O = 10Hz$   | -        | 0.7   | 1    |                |
|  |                               | $f_O = 100Hz$  | -        | 0.7   | 1    |                |
|  |                               | $f_O = 1kHz$   | -        | 0.7   | 1    |                |
| Offset Voltage<br>(Note 4)                     | $V_{OS}$                      | $V_{CB} = 0V, I_C = 100\mu A$                          | -        | 40    | 200  | $\mu V$        |
| Offset Voltage Change<br>vs. Collector Voltage | $\Delta V_{OS}/\Delta V_{CB}$ | $I_C = 100\mu A$<br>$V_{CB1} = 0V$<br>$V_{CB2} = -36V$ | -        | 11    | 200  | $\mu V$        |
| Offset Voltage Change<br>vs. Collector Current | $\Delta V_{OS}/\Delta I_C$    | $V_{CB} = 0V$<br>$I_{C1} = 10\mu A, I_{C2} = 1mA$      | -        | 12    | 75   | $\mu V$        |
| Offset Current                                 | $I_{OS}$                      | $I_C = 100\mu A, V_{CB} = 0V$                          | -        | 6     | 45   | nA             |
| Collector-Base<br>Leakage Current              | $I_{CB0}$                     | $V_{CB} = -36V = V_{MAX}$                              | -        | 50    | 400  | pA             |
| Bulk Resistance                                | $r_{BE}$                      | $V_{CB} = 0V,$<br>$10\mu A \leq I_C \leq 1mA$          | -        | 0.3   | 0.75 | $\Omega$       |
| Collector Saturation<br>Voltage                | $V_{CE(SAT)}$                 | $I_C = 1mA, I_B = 100\mu A$                            | -        | 0.026 | 0.1  | V              |

### NOTES:

- Current gain is measured at collector-base voltages ( $V_{CB}$ ) swept from 0 to  $V_{MAX}$  at indicated collector current. Typical values are measured at  $V_{CB} = 0V$ .
- Current gain matching ( $\Delta h_{FE}$ ) is defined as:

$$\Delta h_{FE} = \frac{100(\Delta I_B) h_{FE} (\text{MIN})}{I_C}$$

- Sample tested. Noise tested and specified as equivalent input voltage for each transistor.

- Offset voltage is defined as:

$$V_{OS} = V_{BE1} - V_{BE2}$$

where  $V_{OS}$  is the differential voltage for

$$I_{C2} = I_{C1} : V_{OS} = V_{BE1} - V_{BE2} = \frac{KT}{q} \ln \left( \frac{I_{C1}}{I_{C2}} \right)$$

**ELECTRICAL CHARACTERISTICS** at  $-40^{\circ}\text{C} \leq T_A \leq +85^{\circ}\text{C}$ , unless otherwise noted.

| PARAMETER                        | SYMBOL     | CONDITIONS                                 | SSM-2220 |     |     | UNITS                          |
|----------------------------------|------------|--|----------|-----|-----|--------------------------------|
|                                  |            |  | MIN      | TYP | MAX |                                |
| Current Gain                     | $h_{FE}$   | $V_{CB} = 0\text{V}, -36\text{V}$          | 60       | 120 | -   |                                |
|                                  |            | $I_C = 1\text{mA}$                         | 50       | 105 | -   |                                |
|                                  |            | $I_C = 100\mu\text{A}$                     | 40       | 90  | -   |                                |
| Offset Voltage                   | $V_{OS}$   | $I_C = 100\mu\text{A}, V_{CB} = 0\text{V}$ | -        | 30  | 265 | $\mu\text{V}$                  |
| Offset Voltage Drift<br>(Note 1) | $TCV_{OS}$ | $I_C = 100\mu\text{A}, V_{CB} = 0\text{V}$ | -        | 0.3 | 1.0 | $\mu\text{V}/^{\circ}\text{C}$ |
| Offset Current                   | $I_{OS}$   | $I_C = 100\mu\text{A}, V_{CB} = 0\text{V}$ | -        | 10  | 200 | nA                             |
| Breakdown Voltage                | $BV_{CEO}$ |  | 36       | -   | -   | V                              |

**NOTE:**

- Guaranteed by  $V_{OS}$  test ( $TCV_{OS} = V_{OS}/T$  for  $V_{OS} \ll V_{BE}$ ) where  $T = 298^{\circ}\text{K}$  for  $T_A = 25^{\circ}\text{C}$ .

**TYPICAL PERFORMANCE CHARACTERISTICS**

**LOW FREQUENCY NOISE**

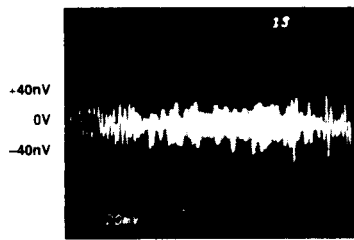

VERTICAL = 40nV/DIV  
HORIZONTAL = 1s/DIV

$V_{CE} = 5\text{V}$   
 $I_C = 1\text{mA}$   
 $T_A = +25^{\circ}\text{C}$

**NOISE FIGURE vs COLLECTOR CURRENT**

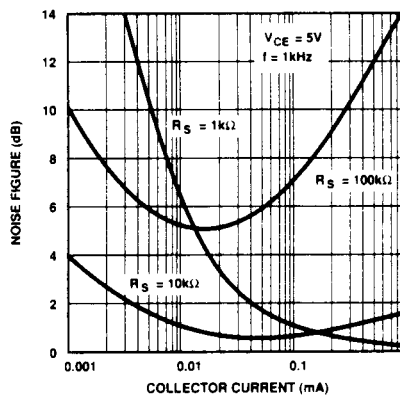

**EMITTER-BASE LOG CONFORMITY**

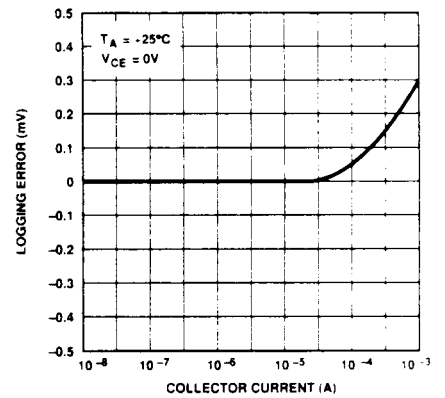

**TOTAL NOISE vs COLLECTOR CURRENT**

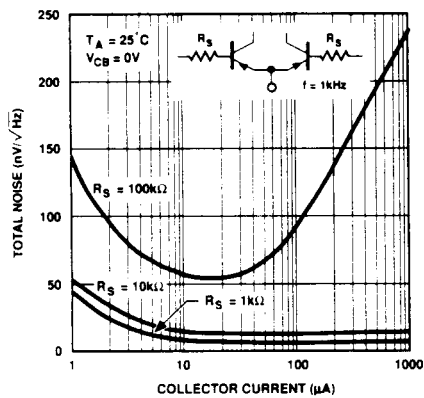

**NOISE VOLTAGE DENSITY vs COLLECTOR CURRENT**

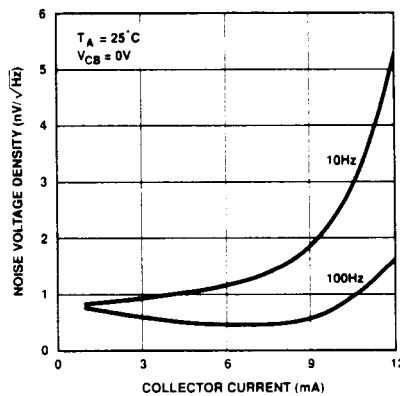

**NOISE VOLTAGE DENSITY vs FREQUENCY**

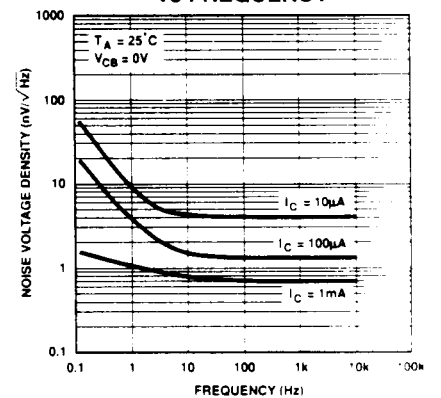

TYPICAL PERFORMANCE CHARACTERISTICS *Continued*

**CURRENT GAIN vs COLLECTOR CURRENT**

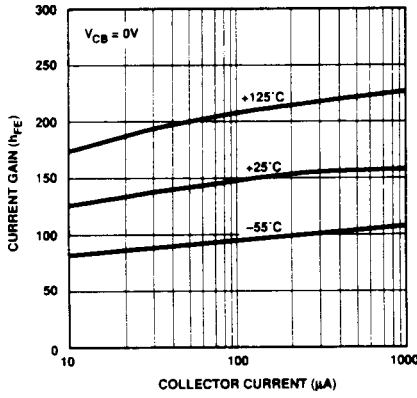

**CURRENT GAIN vs TEMPERATURE**

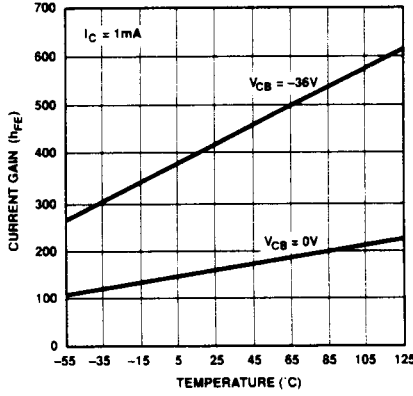

**GAIN BANDWIDTH vs COLLECTOR CURRENT**

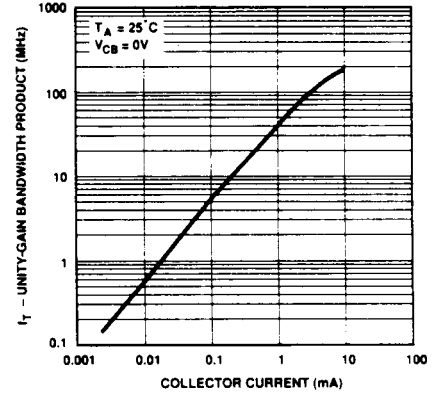

**SATURATION VOLTAGE vs COLLECTOR CURRENT**

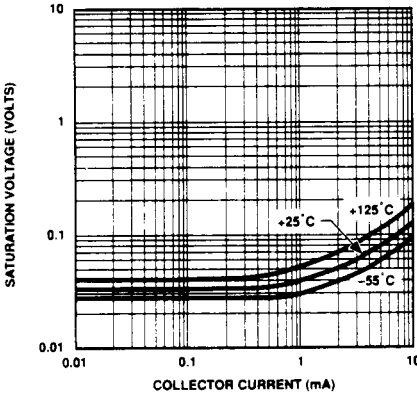

**BASE-EMITTER VOLTAGE vs COLLECTOR CURRENT**

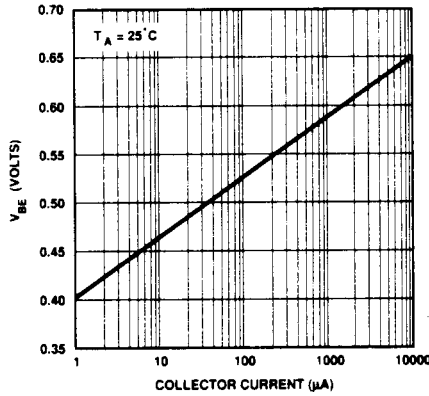

**COLLECTOR-BASE CAPACITANCE vs VCB**

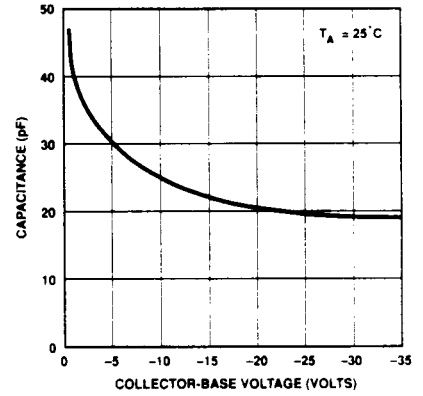

**SMALL-SIGNAL INPUT RESISTANCE ( $h_{ie}$ ) vs COLLECTOR CURRENT**

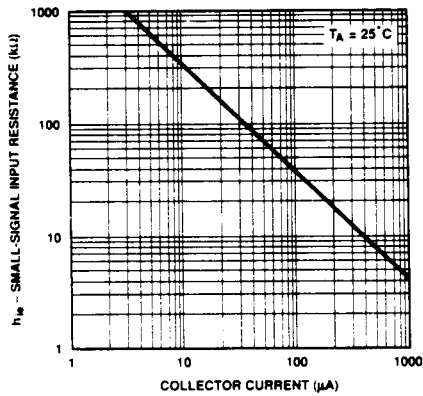

**SMALL-SIGNAL OUTPUT CONDUCTANCE ( $h_{oe}$ ) vs COLLECTOR CURRENT**

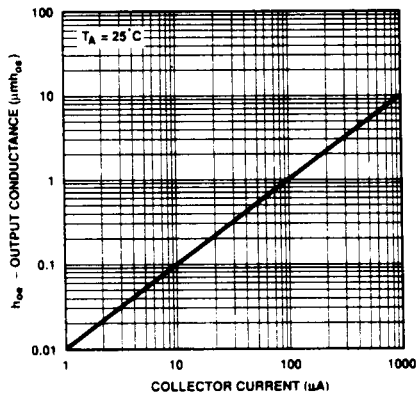

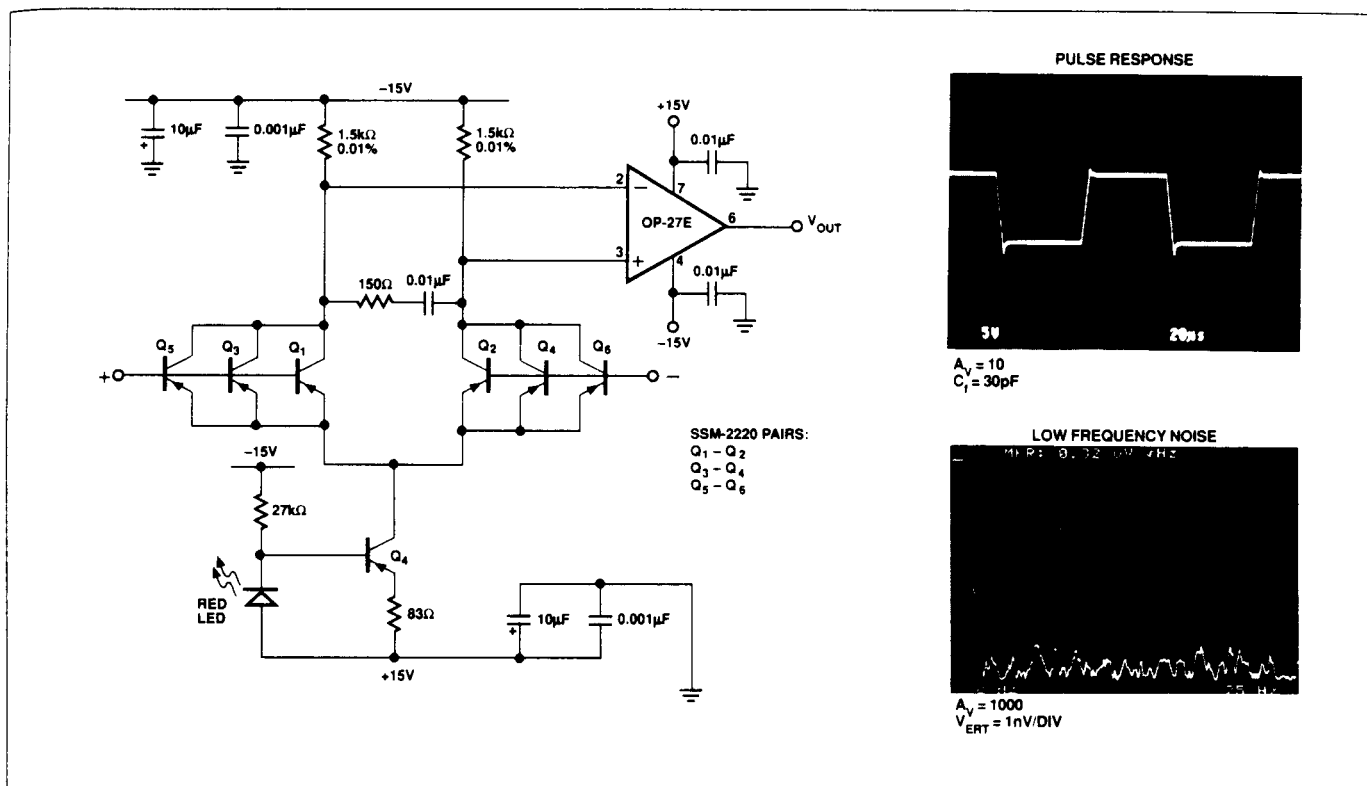

FIGURE 1a: Super Low Noise Amplifier

## APPLICATIONS INFORMATION

### SUPER LOW NOISE AMPLIFIER

The circuit in Figure 1a is a super low noise amplifier with equivalent input voltage noise of  $0.32\text{nV}/\sqrt{\text{Hz}}$ . By paralleling SSM-2220 matched pairs, a further reduction of amplifier noise is attained by a reduction of the base spreading resistance by a factor of 3, and consequently the noise by  $\sqrt{3}$ . Additionally, the shot noise contribution is reduced by maintaining a high collector current (2mA/device) which reduces the dynamic emitter resistance and decreases voltage noise. The voltage noise is inversely proportional to the square root of the stage current, and current noise increases proportionally to the square root of the stage current. Accordingly, this amplifier capitalizes on voltage noise reduction techniques at the expense of increasing the current noise. However, high current noise is not usually important when dealing with low impedance sources.

This amplifier exhibits excellent full power AC performance, 0.08% THD into a 600Ω load, making it suitable for exacting audio applications (see Figure 1b).

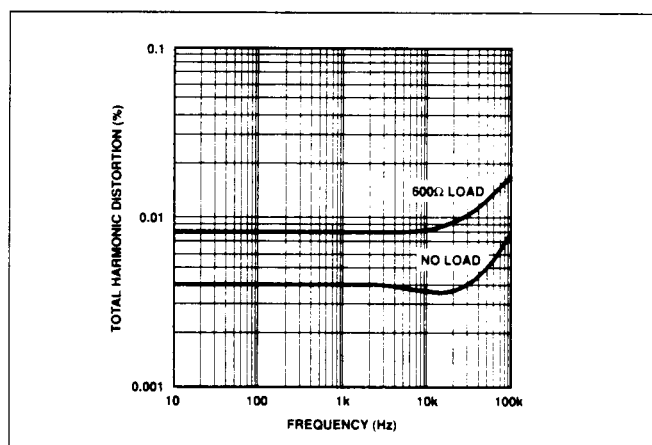

FIGURE 1b: Super Low Noise Amplifier - Total Harmonic Distortion

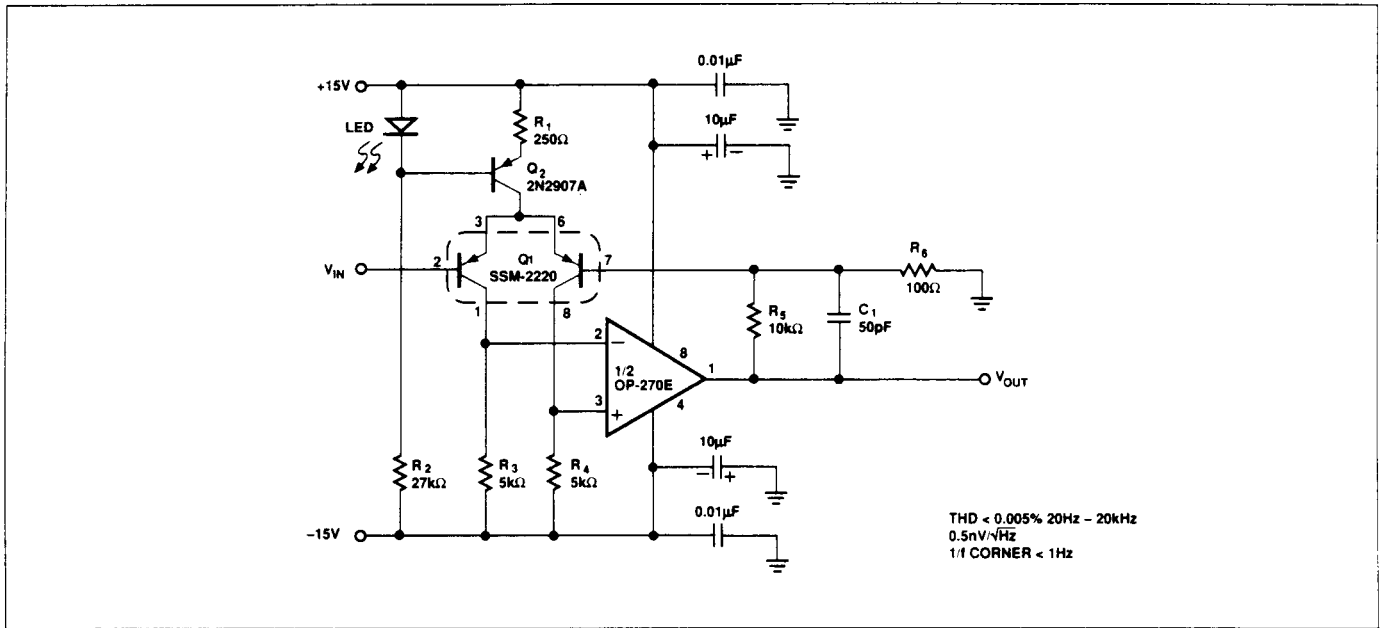

FIGURE 2: Super Low Noise Amplifier

#### LOW NOISE MICROPHONE PREAMPLIFIER

Figure 2 shows a microphone preamplifier that consists of a SSM-2220 and a low noise op amp. The input stage operates at a relatively high quiescent current of 2mA per side, which reduces the SSM-2220 transistor's voltage noise. The  $1/f$  corner is less than 1Hz. Total harmonic distortion is under 0.005% for a 10V<sub>p-p</sub> signal from 20Hz to 20kHz. The preamp gain is 100, but can be modified by varying  $R_5$  or  $R_6$  ( $V_{OUT}/V_{IN} = R_5/R_6 + 1$ ).

A total input stage emitter current of 4mA is provided by  $Q_2$ . The constant current in  $Q_2$  is set by using the forward voltage of a GaAsP LED as a reference. The difference between this voltage and the  $V_{BE}$  of a silicon transistor is predictable and constant (to a few percent) over a wide temperature range. The voltage difference, approximately 1V, is dropped across the 250Ω resistor which produces a temperature stabilized emitter current.

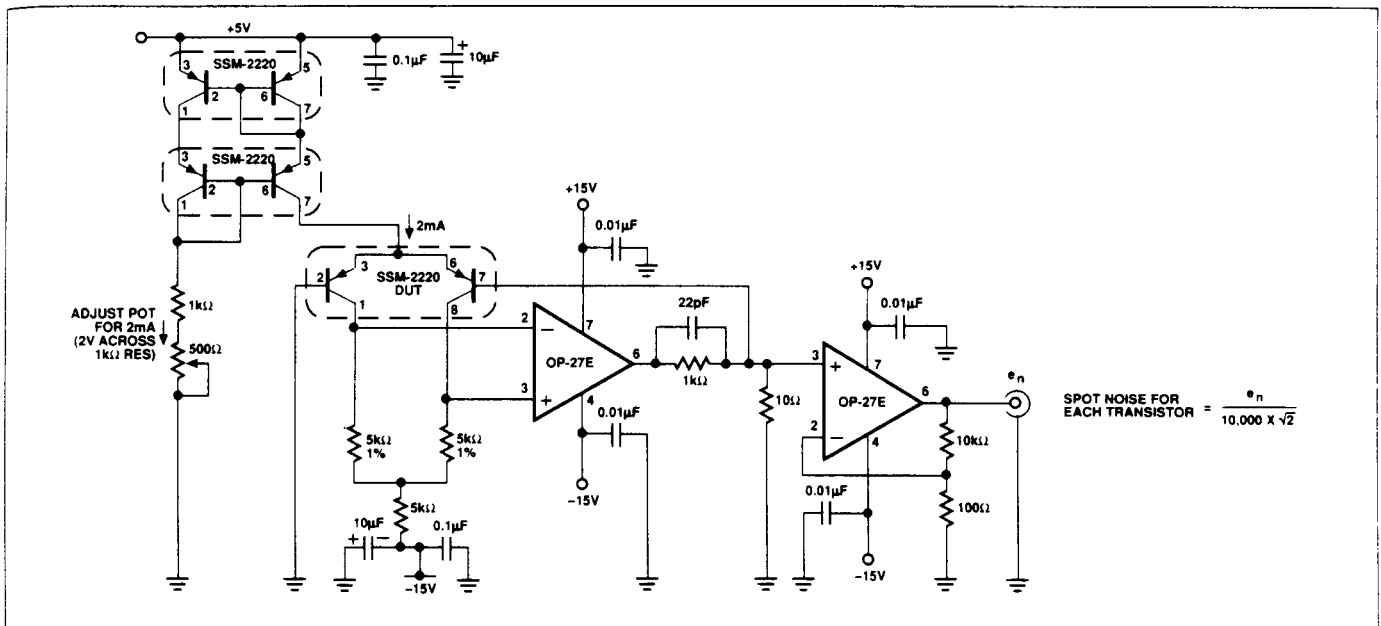

FIGURE 3: SSM-2220 Voltage Noise Measurement Circuit

### SSM-2220 NOISE MEASUREMENT

All resistive components (Johnson noise,  $e_n^2 = 4kTBR$ , or  $e_n = 0.13 \sqrt{R}$  nV/ $\sqrt{\text{Hz}}$ , where  $R$  is in  $k\Omega$ ) and semiconductor junctions (Shot noise, caused by current flowing through a junction, produces voltage noise in series impedances such as transistor-collector load resistors,  $i_n = 0.556 \sqrt{I}$  pA/ $\sqrt{\text{Hz}}$  where  $I$  is in  $\mu\text{A}$ ) contribute to the system input noise.

Figure 3 illustrates a technique for measuring the equivalent input noise voltage of the SSM-2220. 1mA of stage current is used to bias each side of the differential pair. The 5k $\Omega$  collector resistors noise contribution is insignificant compared to the voltage noise of the SSM-2220. Since noise in the signal path is referred back to the input, this voltage noise is attenuated by the gain of the circuit. Consequently, the noise contribution of the collector load resistors is only 0.048nV/ $\sqrt{\text{Hz}}$ . This is considerably less than the typical 0.8nV/ $\sqrt{\text{Hz}}$  input noise voltage of the SSM-2220 transistor.

The noise contribution of the OP-27 gain stages is also negligible due to the gain in the signal path. The op amp stages amplify the input referred noise of the transistors to increase the signal strength to allow the noise spectral density ( $e_n \times 10000$ ) to be measured with a spectrum analyzer. And, since we assume equal noise contributions from each transistor in the SSM-2220, the output is divided by  $\sqrt{2}$  to determine a single transistor's input noise.

Air currents cause small temperature changes that can appear as low frequency noise. To eliminate this noise source, the measurement circuit must be thermally isolated. Effects of extraneous noise sources must also be eliminated by totally shielding the circuit.

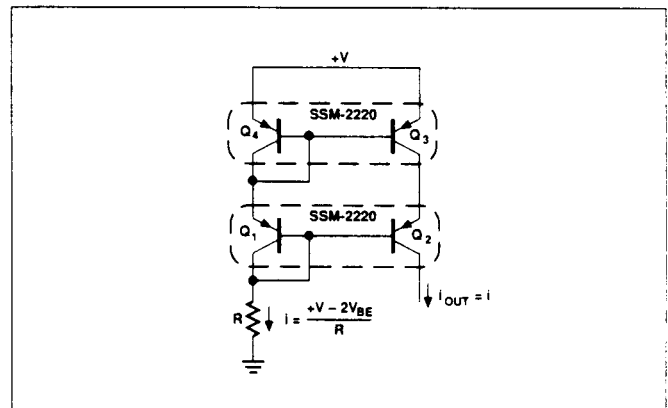

FIGURE 4: Cascode Current Source

### CURRENT SOURCES

A fundamental requirement for accurate current mirrors and active load stages is matched transistor components. Due to the excellent  $V_{BE}$  matching (the voltage difference between  $V_{BE}$ 's required to equalize collector current) and gain matching, the SSM-2220 can be used to implement a variety of standard current mirrors that can source current into a load such as an amplifier stage. The advantages of current loads in amplifiers versus resistors is an increase of voltage gain due to higher impedances, larger signal range, and in many applications, a wider signal bandwidth.

Figure 4 illustrates a cascode current mirror consisting of two SSM-2220 transistor pairs.

# SSM-2220

The cascode current source has a common base transistor in series with the output which causes an increase in output impedance of the current source since  $V_{CE}$  stays relatively constant. High frequency characteristics are improved due to a reduction of Miller capacitance. The small-signal output impedance can be determined by consulting "h<sub>oe</sub> vs. Collector Current" typical graph. Typical output impedance levels approach the performance of a perfect current source.

Considering a typical collector current of 100μA, we have:

$$r_{o_{Q3}} = \frac{1}{1.0\mu\text{MHOS}} = 1\text{M}\Omega.$$

Q<sub>2</sub> and Q<sub>3</sub> are in series and operate at the same current level, so the total output impedance is:

$$R_O = h_{FE} r_{o_{Q3}} \approx (160)(1\text{M}\Omega) = 160\text{M}\Omega.$$

## CURRENT MATCHING

The objective of current source or mirror design is generation of currents that are either matched or must maintain a constant ratio. However, mismatch of base-emitter voltages cause output current errors. Consider the example of Figure 5. If the resistors and transistors are equal and the collector voltages are the same, the collector currents will match precisely. Investigating the current-matching errors resulting from a non-zero V<sub>OS</sub>, we define ΔI<sub>C</sub> as the current error between the two transistors.

Graph 5 describes the relationship of current matching errors versus offset voltage for a specified average current I<sub>C</sub>. Note that since the relative error between the currents is exponentially proportional to the offset voltage, tight matching is required to design high accuracy current sources. For example, if the offset voltage is 5mV at 100μA collector current, the current matching error would be 20%. Additionally, temperature effects such as offset drift (3μV/°C per mV of V<sub>OS</sub>) will degrade performance if Q<sub>1</sub> and Q<sub>2</sub> are not well matched.

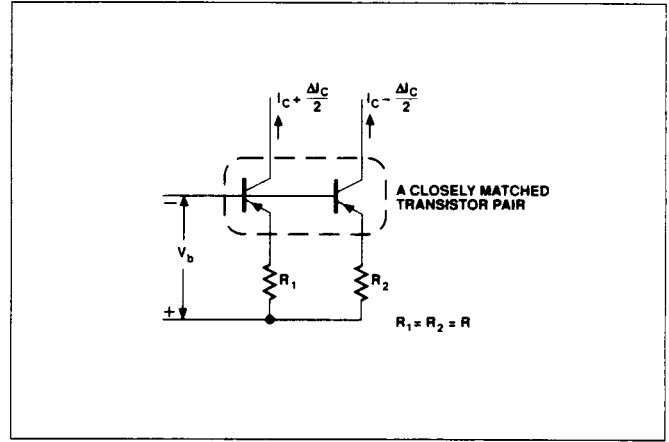

FIGURE 5a: Current Matching Circuit

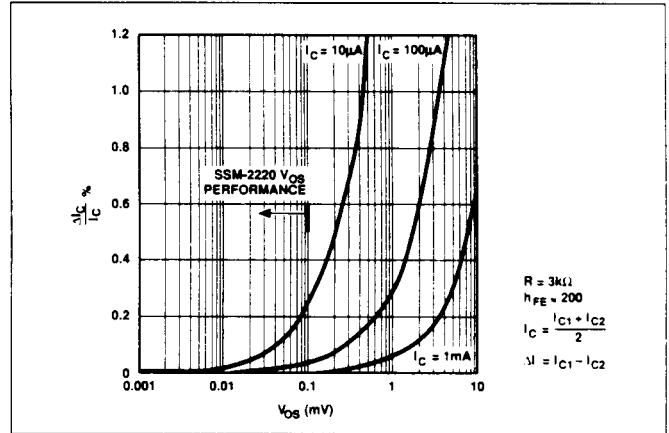

FIGURE 5b: Current Matching Accuracy % vs. Offset Voltage