

8 Line ESD/EMI Protection for Color LCD Interfaces

UM8401 DFN16 4.0×1.6

General Description

The UM8401 is a low pass filter array with integrated TVS diodes. It is designed to suppress unwanted EMI/RFI signals and provide electrostatic discharge (ESD) protection in portable electronic equipment. This state-of-the-art device utilizes silicon-avalanche technology for superior clamping performance and DC electrical characteristics. It has been optimized for protection of color LCD panels in cellular phones and other portable electronics.

The device consists of eight identical circuits comprised of TVS diodes for ESD protection, and a RC network for EMI filtering. A series resistor value of 100Ω and a capacitance value of 10pF are used to achieve 25dB minimum attenuation from 800 MHz to 2.5GHz. The TVS diodes provide effective suppression of ESD voltages in excess of ±15kV (air discharge) and ±8kV (contact discharge) per IEC 61000-4-2, level 4.

The UM8401 is in a 16-pin, RoHS compliant DFN16 package. It measures 4.0mm x 1.6mm. The leads are spaced at a pitch of 0.5mm and are finished with lead-free Ni Pd. The small package makes it ideal for use in portable electronics such as cell phones, digital still cameras, and PDAs.

Applications

EMI Filtering and ESD Protection for Data Lines
Wireless Phones
Handheld Products
Notebook Computers
LCD Displays

Features

- EMI/RFI Filter with Integrated TVS for ESD Protection
- ESD Protection to IEC 61000-4-2 (ESD) Level 4, ±15kV (air), ±8kV (contact)
- 25dB Minimum Attenuation: 800MHz to 2.5GHz
- Working Voltage: 5V
- Resistor: 100Ω ±15%
- Typical Capacitance: 13pF (VR = 2.5V)
- Solid-state Technology
- DFN16 Package: 4.0mm x 1.6 mm
- Moisture Sensitivity Level 1

Pin Configurations

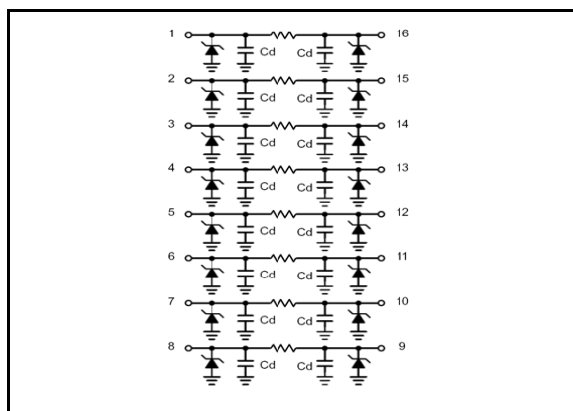

Top View

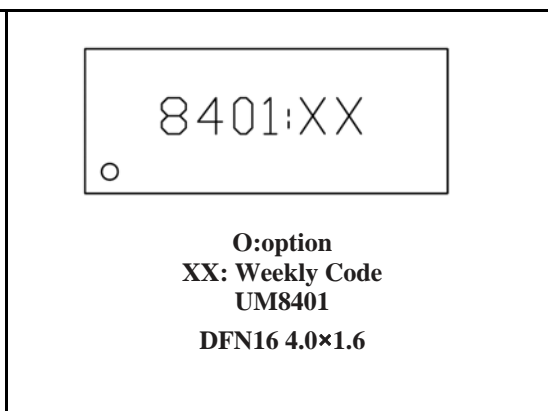

Ordering Information

Part Number	Working Voltage	Packaging Type	Channel	Marking Code	Shipping Qty
UM8401	5.0V	DFN16 L×W=4.0×1.6mm ²	8	8401	3000 /7 Inch Tape & Reel

Absolute Maximum Ratings

PARAMETER	SYMBOL	VALUE	UNIT
Junction Temperature	T _J	125	°C
Steady State Power per Resistor @ 25°C	P _R	328	mW
Operating Temperature Range	T _{OP}	-40 to 85	°C
Storage Temperature Range	T _{STG}	-55 to 150	°C
Maximum Lead Temperature for Soldering	T _L	260	°C

Electrical Characteristics

PARAMETER	SYMBOL	TEST CONDITIONS	MIN	TYP	MAX	UNIT
Reverse Stand-Off Voltage	V _{RWM}				5.0	V
Reverse Breakdown Voltage	V _{BR}	I _t = 1mA	6.0	7.0	8.0	V
Reverse Leakage Current	I _R	V _{RWM} = 3.3V			100	nA
Total Series Resistance	R _A	I _R = 20mA Each Line	85	100	115	Ω
Total Capacitance	C _d	Input to Gnd, Each Line V _R = 0V, f = 1MHz	16	20	24	pF
Total Capacitance	C _d	Input to Gnd, Each Line V _R = 2.5V, f = 1MHz	11	13	15	pF
Cut-Off Frequency (Notes)	f _{3dB}	Above this frequency, appreciable attenuation occurs		150		MHz

Notes: 50Ω source and 50Ω load termination.

Typical Operating Characteristics

Typical Insertion Loss S21

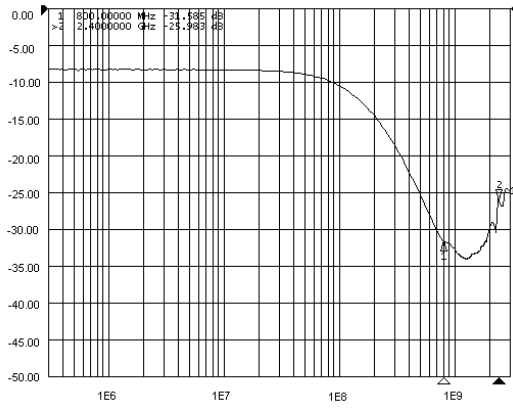

Analog Crosstalk Curve (S41)

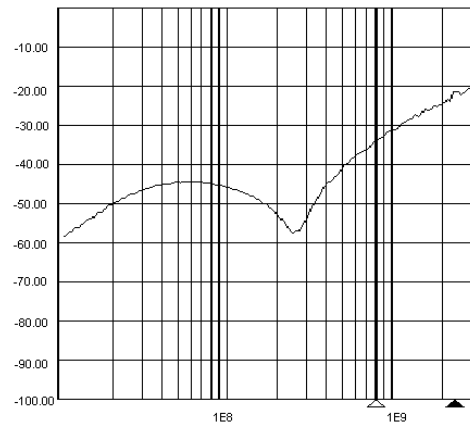

Typical Resistance vs. Temperature

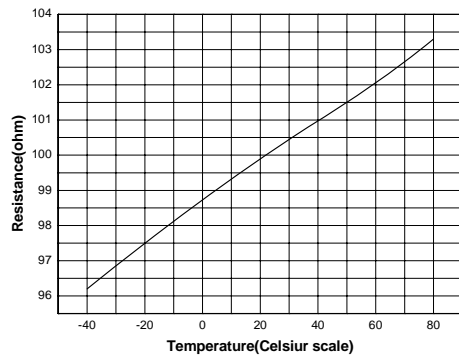

Capacitance vs. Reverse Voltage

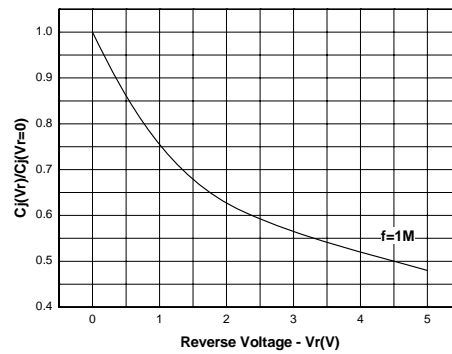

Applications Information

Device Connection

The UM8401 is comprised of eight identical circuits each consisting of a low pass filter for EMI/RFI suppression and dual TVS diodes for ESD protection. The device is in a 16-pin DFN package. Electrical connection is made to the 16 pins located at the bottom of the device. A center tab serves as the ground connection. The device has a flow through design for easy layout. All path lengths should be kept as short as possible to minimize the effects of parasitic inductance in the board traces. Recommendations for the ground connection are given below.

Ground Connection Recommendation

Parasitic inductance present in the board layout will affect the filtering performance of the device. As frequency increases, the effect of the inductance becomes more dominant. This effect is given by Equation 1.

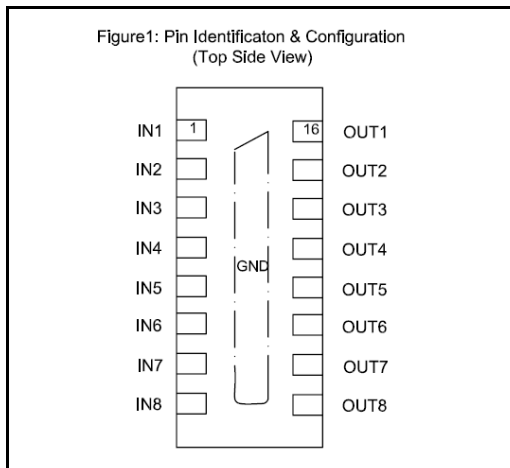

Pin	Identification
1 - 8	Input Lines
9 - 16	Output Lines
Center Tab	Ground

Equation 1: The Impedance of an Inductor at Frequency XLF

$$X_{LF}(L, f) = 2 \times \pi \times f \times L$$

Where:
 L = Inductance (H)
 f = Frequency (Hz)

Via connections to the ground plane form rectangular wire loops or ground loop inductance as shown in Figure 2. Ground loop inductance can be reduced by using multiple vias to make the connection to the ground plane. Bringing the ground plane closer to the signal layer (preferably the next layer) also reduces ground loop inductance. Multiple vias in the device ground pad will result in a lower inductive ground loop over two exterior vias. Vias with a diameter d are separated by a distance y run between layers separated by a distance x . The inductance of the loop path is given by Equation 2. Thus, decreasing distance x and y will reduce the loop inductance and result in better high frequency filter characteristics.

Figure 2 - Inductance of Rectangular Wire Loops

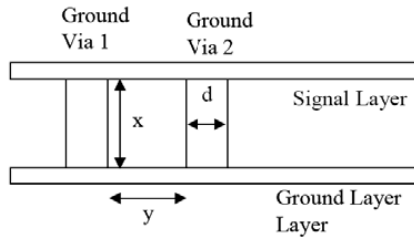

Equation 2: Inductance of Rectangular Wire Loop

$$L_{RECT}(d, x, y) = 10.16 * 10^{-9} * \left[x * \ln\left[\frac{2*y}{d}\right] + y * \ln\left[\frac{2*x}{d}\right] \right]$$

Where:

d = Diameter of the wire (in)

x = Length of wire loop (in)

y = Breath of wire loop (in)

Figure 3 shows the recommended device layout. The ground pad vias have a diameter of 0.008 inches (0.20 mm) while the two external vias have a diameter of 0.010 inches (0.250mm). The internal vias are spaced approximately evenly from the center of the pad. The designer may choose to use more vias with a smaller diameter (such as 0.005 inches or 0.125mm) since changing the diameter of the via will result in little change in inductance (i.e. the log function in Equation 2 is highly insensitive to parameter d).

Figure 3 – Recommended Layout Using Ground Vias

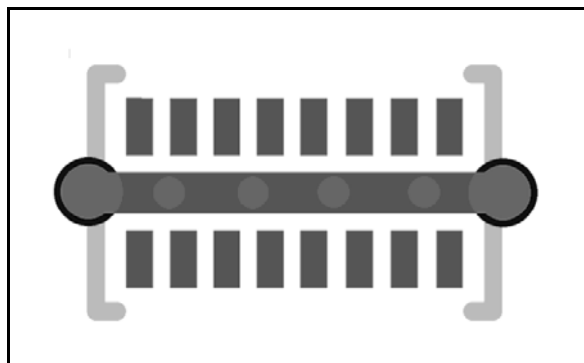

Package Information

DFN16 4x1.6

Outline Drawing

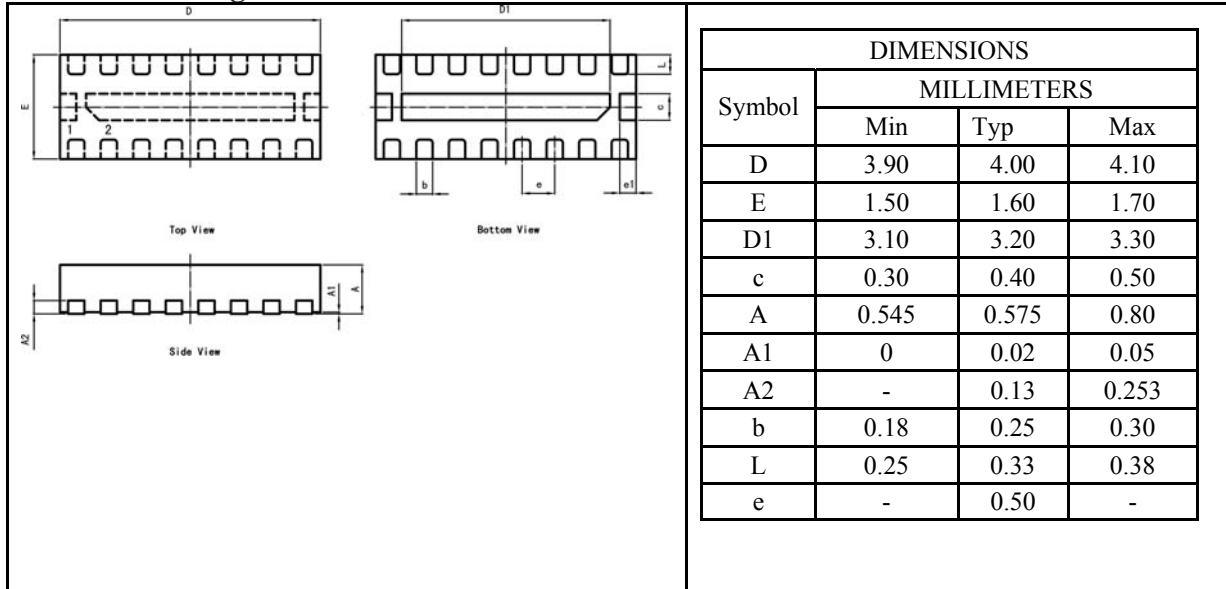

Land Pattern

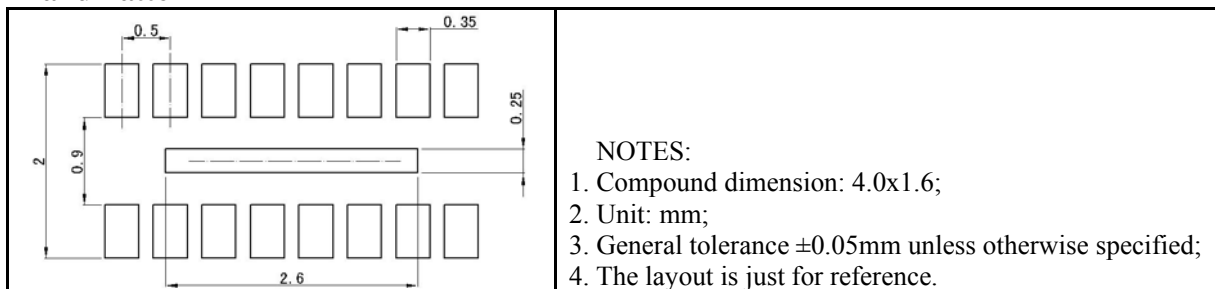

Tape and Reel Orientation



IMPORTANT NOTICE

The information in this document has been carefully reviewed and is believed to be accurate. Nonetheless, this document is subject to change without notice. Union assumes no responsibility for any inaccuracies that may be contained in this document, and makes no commitment to update or to keep current the contained information, or to notify a person or organization of any update. Union reserves the right to make changes, at any time, in order to improve reliability, function or design and to attempt to supply the best product possible.

Union Semiconductor, Inc
Add: 7F, No. 5, Bibo Road, Shanghai 201203
Tel: 021-51097928
Fax: 021-51026018
Website: www.union-ic.com