

The RF MOSFET Line
RF Power Field-Effect Transistor
N-Channel Enhancement-Mode Lateral MOSFET

Designed for broadband commercial and industrial applications with frequencies from 470 to 860 MHz. The high gain and broadband performance of this device make it ideal for large-signal, common source amplifier applications in 32 volt transmitter equipment.

- Typical Narrowband Two-Tone Performance @ f1 = 857 MHz, f2 = 863 MHz, 32 Volts
Output Power — 180 Watts PEP
Power Gain — 17 dB
Efficiency — 36%
IMD — -35 dBc
- Typical Broadband Two-Tone Performance @ f1 = 857 MHz, f2 = 863 MHz, 32 Volts
Output Power — 180 Watts PEP
Power Gain — 14.5 dB
Efficiency — 37%
IMD — -31 dBc
- Internally Matched, Controlled Q, for Ease of Use
- Integrated ESD Protection
- 100% Tested for Load Mismatch Stress at All Phase Angles with 3:1 VSWR @ 32 Vdc, f1 = 857 MHz, f2 = 863 MHz, 180 Watts PEP
- Excellent Thermal Stability
- Characterized with Series Equivalent Large-Signal Impedance Parameters

MRF372

470 – 860 MHz, 180 W, 32 V
LATERAL N-CHANNEL
RF POWER MOSFET

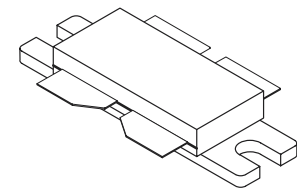

CASE 375G-04, STYLE 1
NI-860C3

MAXIMUM RATINGS (1)

Rating	Symbol	Value	Unit
Drain-Source Voltage	V _{DSS}	68	Vdc
Gate-Source Voltage	V _{GS}	- 0.5, +15	Vdc
Drain Current – Continuous	I _D	17	Adc
Total Device Dissipation @ T _C = 25°C Derate above 25°C	P _D	350 2.0	W W/°C
Storage Temperature Range	T _{stg}	- 65 to +150	°C
Operating Junction Temperature	T _J	200	°C

ESD PROTECTION CHARACTERISTICS

Test Conditions	Class
Human Body Model	1 (Minimum)
Machine Model	M3 (Minimum)

THERMAL CHARACTERISTICS

Characteristic	Symbol	Max	Unit
Thermal Resistance, Junction to Case	R _{θJC}	0.5	°C/W

(1) Each side of device measured separately.

NOTE – **CAUTION** – MOS devices are susceptible to damage from electrostatic charge. Reasonable precautions in handling and packaging MOS devices should be observed.

ELECTRICAL CHARACTERISTICS ($T_C = 25^\circ\text{C}$ unless otherwise noted)

Characteristic	Symbol	Min	Typ	Max	Unit
OFF CHARACTERISTICS (1)					
Drain–Source Breakdown Voltage ($V_{GS} = 0 \text{ Vdc}$, $I_D = 10 \mu\text{A}$)	$V_{(BR)DSS}$	68	—	—	Vdc
Zero Gate Voltage Drain Current ($V_{DS} = 32 \text{ Vdc}$, $V_{GS} = 0 \text{ Vdc}$)	I_{DSS}	—	—	10	μAdc
Gate–Source Leakage Current ($V_{GS} = 5 \text{ Vdc}$, $V_{DS} = 0 \text{ Vdc}$)	I_{GSS}	—	—	1	μAdc
ON CHARACTERISTICS (1)					
Gate Threshold Voltage ($V_{DS} = 10 \text{ V}$, $I_D = 200 \mu\text{A}$)	$V_{GS(th)}$	2	3	4	Vdc
Gate Quiescent Voltage ($V_{DS} = 32 \text{ V}$, $I_D = 100 \text{ mA}$)	$V_{GS(Q)}$	2.5	3.5	4.5	Vdc
Drain–Source On–Voltage ($V_{GS} = 10 \text{ V}$, $I_D = 3 \text{ A}$)	$V_{DS(on)}$	—	0.28	0.45	Vdc
Forward Transconductance ($V_{DS} = 10 \text{ V}$, $I_D = 3 \text{ A}$)	g_{fs}	—	2.6	—	S
DYNAMIC CHARACTERISTICS (1)					
Input Capacitance (Includes Input Matching Capacitance) ($V_{DS} = 32 \text{ V}$, $V_{GS} = 0 \text{ V}$, $f = 1 \text{ MHz}$)	C_{iss}	—	260	—	pF
Output Capacitance ($V_{DS} = 32 \text{ V}$, $V_{GS} = 0 \text{ V}$, $f = 1 \text{ MHz}$)	C_{oss}	—	69	—	pF
Reverse Transfer Capacitance ($V_{DS} = 32 \text{ V}$, $V_{GS} = 0 \text{ V}$, $f = 1 \text{ MHz}$)	C_{rss}	—	2.5	—	pF
FUNCTIONAL CHARACTERISTICS, NARROWBAND OPERATION (In Motorola MRF372 Narrowband Circuit, 50 ohm system) (2)					
Common Source Power Gain ($V_{DD} = 32 \text{ V}$, $P_{out} = 180 \text{ W PEP}$, $I_{DQ} = 2 \times 400 \text{ mA}$, $f_1 = 857 \text{ MHz}$, $f_2 = 863 \text{ MHz}$)	G_{ps}	16	17	—	dB
Drain Efficiency ($V_{DD} = 32 \text{ V}$, $P_{out} = 180 \text{ W PEP}$, $I_{DQ} = 2 \times 400 \text{ mA}$, $f_1 = 857 \text{ MHz}$, $f_2 = 863 \text{ MHz}$)	η	33	36	—	%
Intermodulation Distortion ($V_{DD} = 32 \text{ Vdc}$, $P_{out} = 180 \text{ W PEP}$, $I_{DQ} = 2 \times 400 \text{ mA}$, $f_1 = 857 \text{ MHz}$, $f_2 = 863 \text{ MHz}$)	IMD	—	–35	–31	dBc
Output Mismatch Stress ($V_{DD} = 32 \text{ Vdc}$, $P_{out} = 180 \text{ W PEP}$, $I_{DQ} = 2 \times 400 \text{ mA}$, $f_1 = 857 \text{ MHz}$, $f_2 = 863 \text{ MHz}$, $V_{SWR} = 3:1$ at all phase angles of test)	ψ	No Degradation in Output Power			
TYPICAL CHARACTERISTICS, BROADBAND OPERATION (In Motorola MRF372 Broadband Circuit, 50 ohm system) (2)					
Common Source Power Gain ($V_{DD} = 32 \text{ Vdc}$, $P_{out} = 180 \text{ W PEP}$, $I_{DQ} = 2 \times 500 \text{ mA}$, $f_1 = 857 \text{ MHz}$, $f_2 = 863 \text{ MHz}$)	G_{ps}	—	14.5	—	dB
Drain Efficiency ($V_{DD} = 32 \text{ Vdc}$, $P_{out} = 180 \text{ W PEP}$, $I_{DQ} = 2 \times 500 \text{ mA}$, $f_1 = 857 \text{ MHz}$, $f_2 = 863 \text{ MHz}$)	η	—	37	—	%
Intermodulation Distortion ($V_{DD} = 32 \text{ Vdc}$, $P_{out} = 180 \text{ W PEP}$, $I_{DQ} = 2 \times 500 \text{ mA}$, $f_1 = 857 \text{ MHz}$, $f_2 = 863 \text{ MHz}$)	IMD	—	–31	—	dBc

(1) Each side of device measured separately.

(2) Measured in push–pull configuration.

TYPICAL CHARACTERISTICS

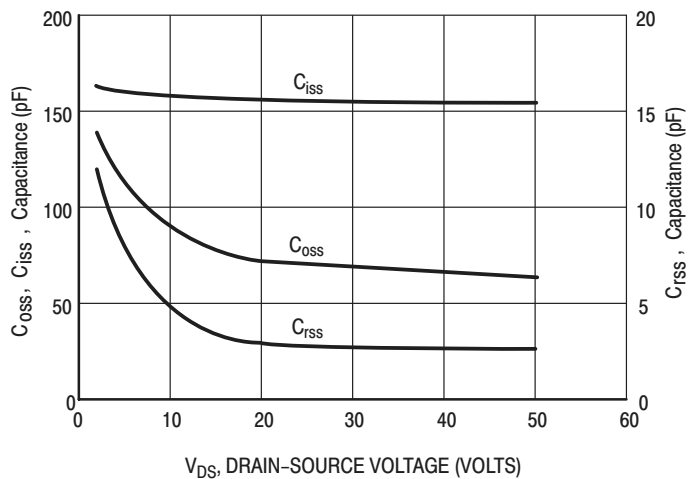

Note: C_{iss} does not include input matching capacitance.

Figure 1. Capacitance versus Voltage

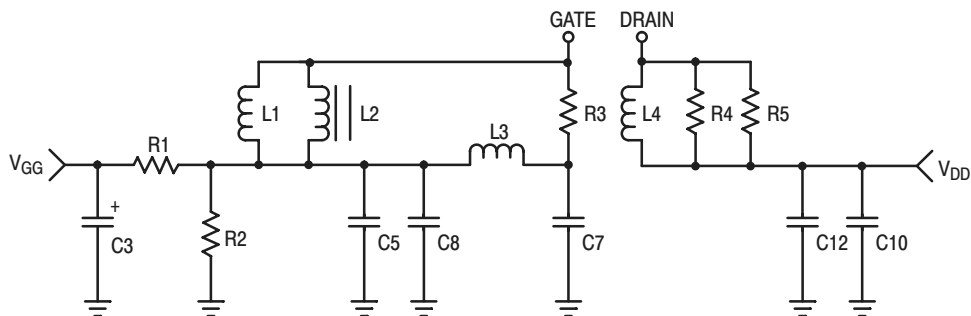
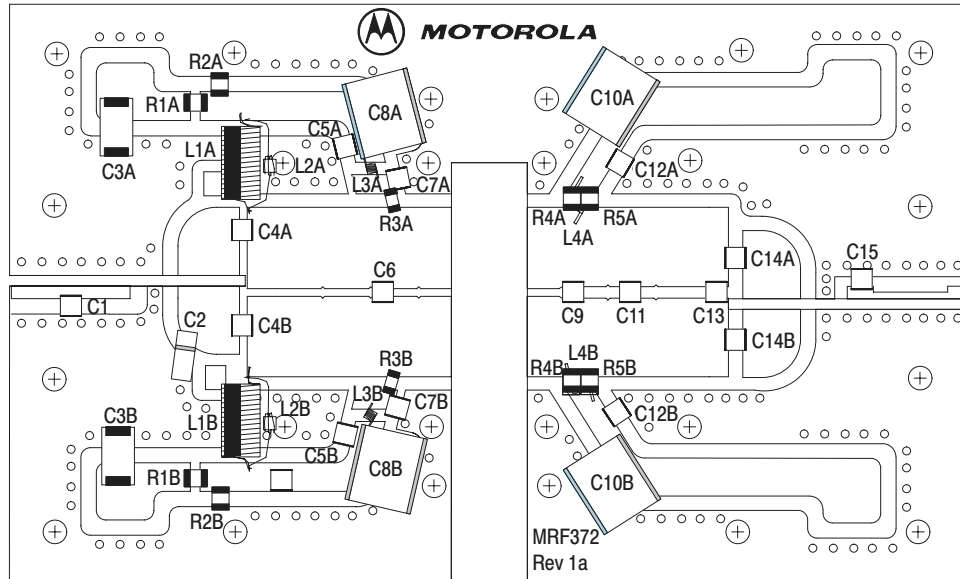

Figure 2. 860 MHz Narrowband DC Bias Networks

Table 1. 860 MHz Narrowband DC Bias Networks Component Designations and Values

Designation	Description
C1	2.2 pF Chip Capacitor, B Case, ATC
C2	0.5 — 5.0 pF Variable Capacitor, B Case, Johansen Gigatrim
C3A, B	22 μ F, 22 V Tantalum Chip Capacitors, Kemet #T491D226K22AS
C4A, B, C14A, B	47.0 pF Chip Capacitors, B Case, ATC
C5A, B	100 pF Chip Capacitors, B Case, ATC
C6	10.0 pF Chip Capacitor, B Case, ATC
C7A, B	2.7 pF Chip Capacitors, A Case, ATC
C8A, B	1.0 μ F, 100 V Chip Capacitors, Vitramon #VJ3640Y105KXBAT
C9	10.0 pF Chip Capacitor, B Case, ATC
C10A, B	2.2 μ F, 100 V Chip Capacitors, Vitramon #VJ3640Y225KXBAT
C11	5.1 pF Chip Capacitor, B Case, ATC
C12A, B	0.01 μ F, 100 V Chip Capacitors, Kemet #VJ1210Y103KXBAT
C13	3.9 pF Chip Capacitor, B Case, ATC
C15	1.2 pF Chip Capacitor, B Case, ATC
L1A, B	130 nH, Coilcraft #132-11SM
L2A, B	#24 AWG, 3 Turns Loose, Fair Rite #2643706001
L3A, B	3.85 nH, Coilcraft #0906-4
L4A, B	5.0 nH, Coilcraft #A02T
R1A, B, R2A, B R4A, B, R5A, B	180 Ω , 1/4 W Chip Resistors, Vishay Dale (1210)
R3A, B	12 Ω , 1/8 W Chip Resistors, Vishay Dale (1206)
PCB	MRF372 Printed Circuit Board Rev 1a, Rogers RO4350, Height 30 mils, $\epsilon_r = 3.48$
Balun A, B	Vertical 860 MHz Broadband Balun, Printed Circuit Board Rev 01, Rogers RO3010, Height 50 mils, $\epsilon_r = 10.2$



Vertical Balun Mounting Detail

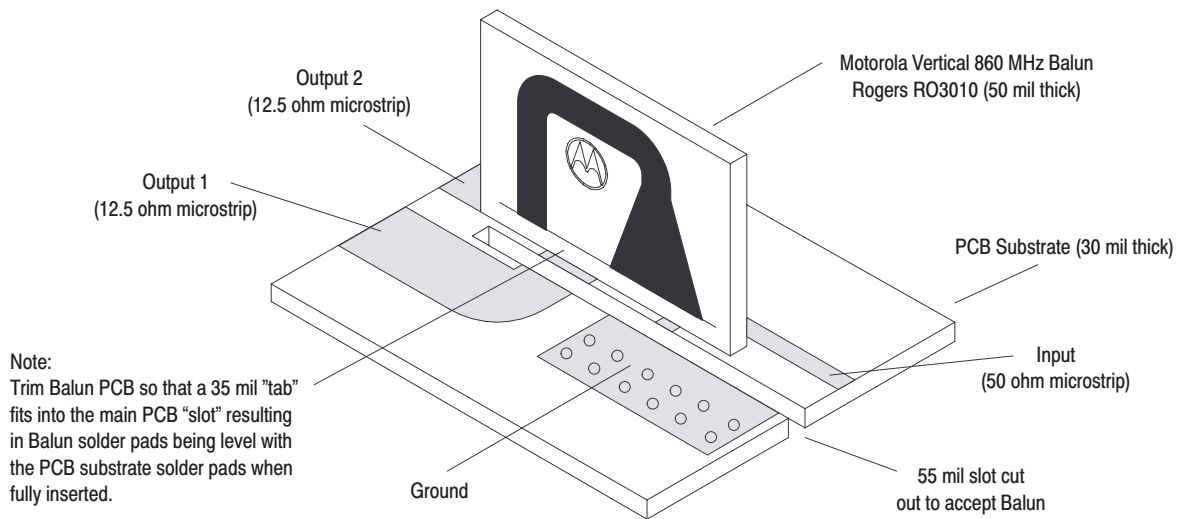
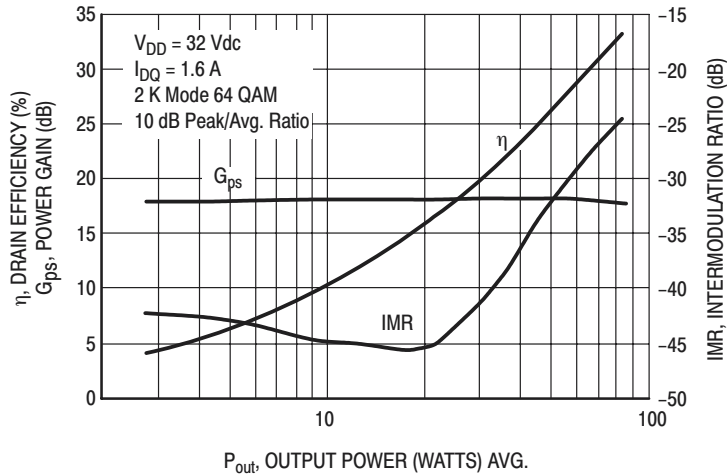

Figure 3. 860 MHz Narrowband Component Layout

TYPICAL TWO-TONE NARROWBAND CHARACTERISTICS



Note: IMR measured using Delta Marker Method.

Figure 4. COFDM Performance (860 MHz)

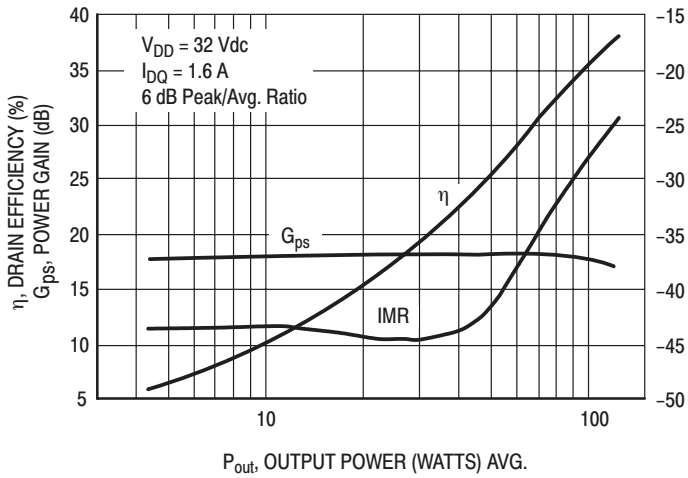

Note: IMR measured using Delta Marker Method.

Figure 5. 8-VSB Performance (860 MHz)

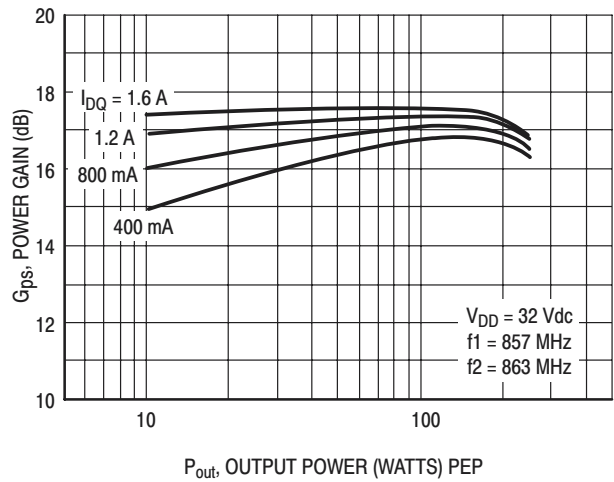

Figure 6. Power Gain versus Output Power

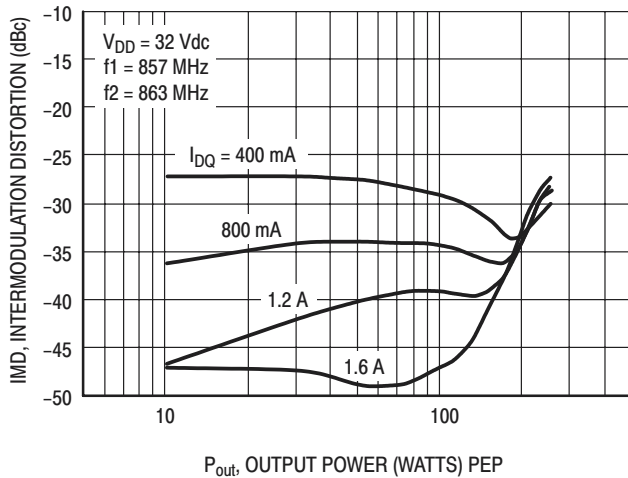

Figure 7. Intermodulation Distortion versus Output Power

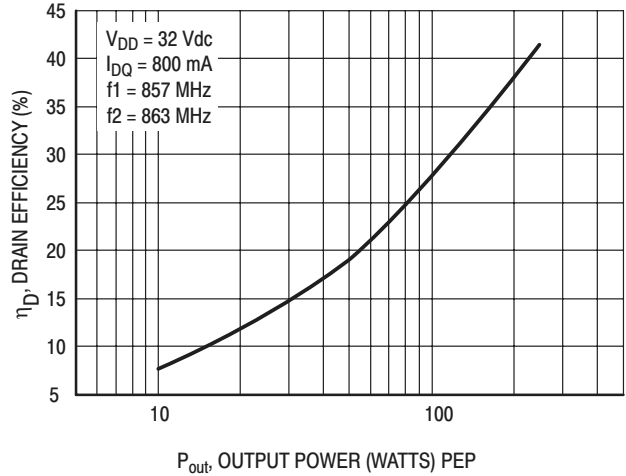
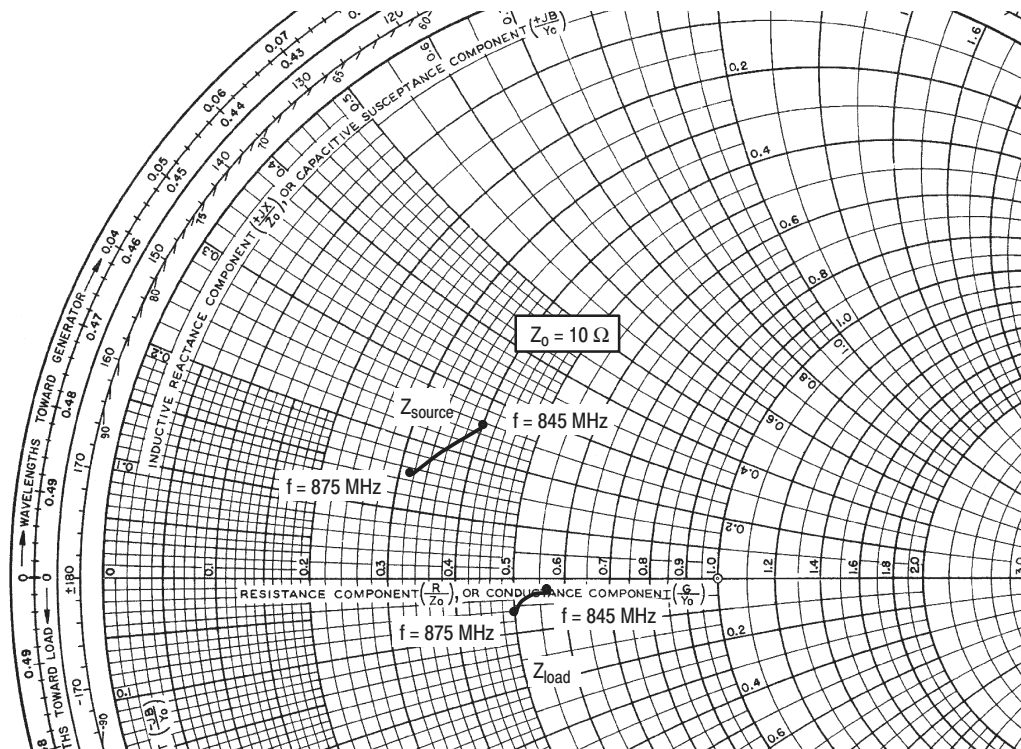

Figure 8. Drain Efficiency versus Output Power



$V_{DD} = 32\text{ V}$, $I_{DQ} = 800\text{ mA}$, $P_{out} = 180\text{ W PEP}$

f MHz	Z_{source} Ω	Z_{load} Ω
845	$3.99 + j2.50$	$5.63 - j0.38$
860	$3.56 + j1.98$	$5.28 - j0.43$
875	$3.18 + j1.46$	$4.94 - j0.56$
Harmonics		
f GHz	Z_{source} Ω	Z_{load} Ω
1.69	$2.85 - j14.30$	$1.23 - j9.37$
1.72	$3.27 - j14.32$	$1.54 - j9.60$
1.75	$3.35 - j14.36$	$1.73 - j9.62$

Z_{source} = Test circuit impedance as measured from gate to gate, balanced configuration.

Z_{load} = Test circuit impedance as measured from drain to drain, balanced configuration.

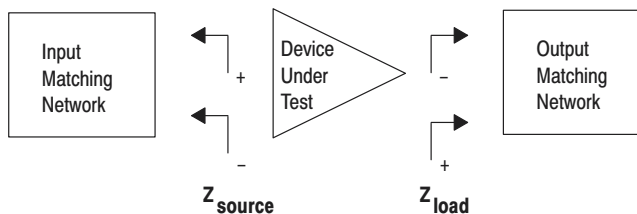

Figure 9. Narrowband Series Equivalent Input and Output Impedance

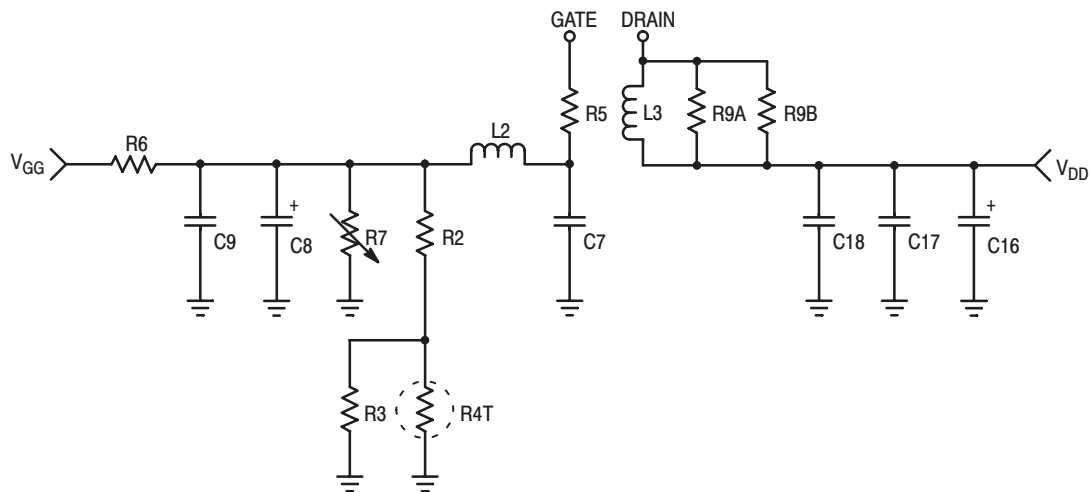
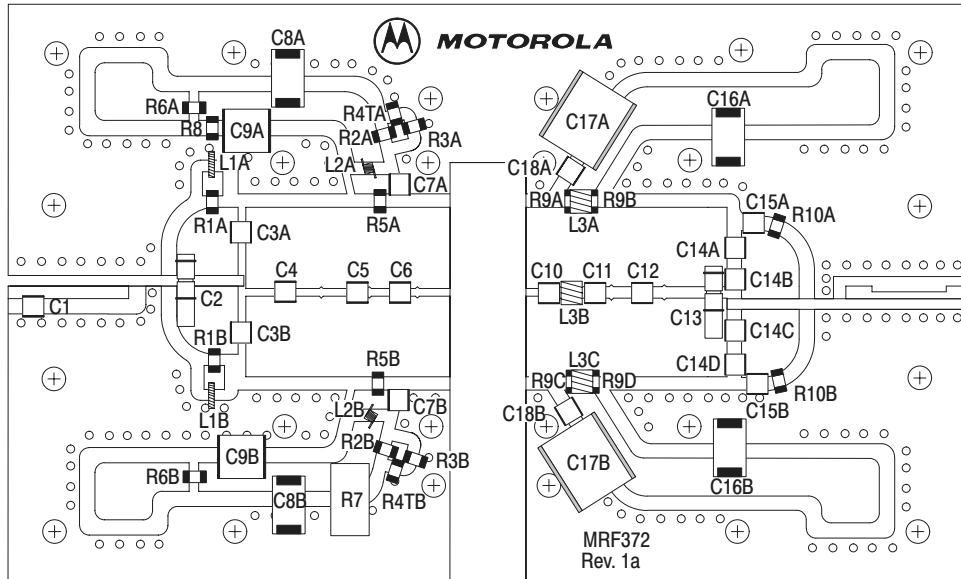

Figure 10. 470–860 MHz Broadband DC Bias Networks

Table 2. 470–860 MHz Broadband DC Bias Networks Component Designations and Values

Designation	Description
C1	0.7 pF Chip Capacitor, B Case, ATC
C2, C13	0.8 — 8.0 pF Variable Capacitors, Johansen Gigatrim
C3A, B, C14A, B, C, D	100 pF Chip Capacitors, B Case, ATC
C4	4.7 pF, Chip Capacitor, B Case, ATC
C5	7.5 pF Chip Capacitor, B Case, ATC
C6	10.0 pF Chip Capacitor, B Case, ATC
C7A, B	6.2 pF Chip Capacitors, A Case, ATC
C8A, B	22 μ F, 22 V Tantalum Chip Capacitors, Kemet #T491D226K22AS
C9A, B	0.1 μ F, 100 V Chip Capacitors, Vitramon #VJ3640Y104KXBAT
C10	13 pF Chip Capacitor, B Case, ATC
C11	6.8 pF Chip Capacitor, B Case, ATC
C12	3.9 pF Chip Capacitor, B Case, ATC
C15A, B	3.3 pF Chip Capacitors, B Case, ATC
C16A, B	10 μ F, 35 V Tantalum Chip Capacitors, Kemet #T491D106K35AS
C17A, B	3.3 μ F, 100 V Chip Capacitors, Vitramon #VJ3640Y335KXBAT
C18A, B	0.01 μ F Chip Capacitors, B Case, ATC
L1A, B	12.55 nH, Coilcraft #1606–10
L2A, B	5.45 nH, Coilcraft #0906–5
L3A, B, C	12.5 nH, Coilcraft #A04T
R1A, B	10 Ω , 1/4 W Chip Resistors, Vishay Dale (1210)
R2A, B	2.2 k Ω , 1/4 W Chip Resistors, Vishay Dale (1210)
R3A, B, R10A, B	390 Ω , 1/8 W Chip Resistors, Vishay Dale (1206)
R4TA, B	520 Ω , Thermistor, Vishay #NTHS—1206J14520R5%
R5A, B	6.2 Ω , 1/4 W Chip Resistors, Vishay Dale (1210)
R6A, B	6.8 k Ω , 1/4 W Chip Resistors, Vishay Dale (1210)
R7	100 k Ω Potentiometer, Bourns
R8	47.3 k Ω , 1/8 W Chip Resistor, Vishay Dale (1206)
R9A, B, C, D	180 Ω , 1/4 W Chip Resistors, Vishay Dale (1210)
PCB	MRF372 Printed Circuit Board Rev 1a, Rogers RO4350, Height 30 mils, $\epsilon_r = 3.48$
Balun A, B	Vertical 660 MHz Broadband Balun, Printed Circuit Board Rev 01, Rogers RO3010, Height 50 mils, $\epsilon_r = 10.2$



Vertical Balun Mounting Detail

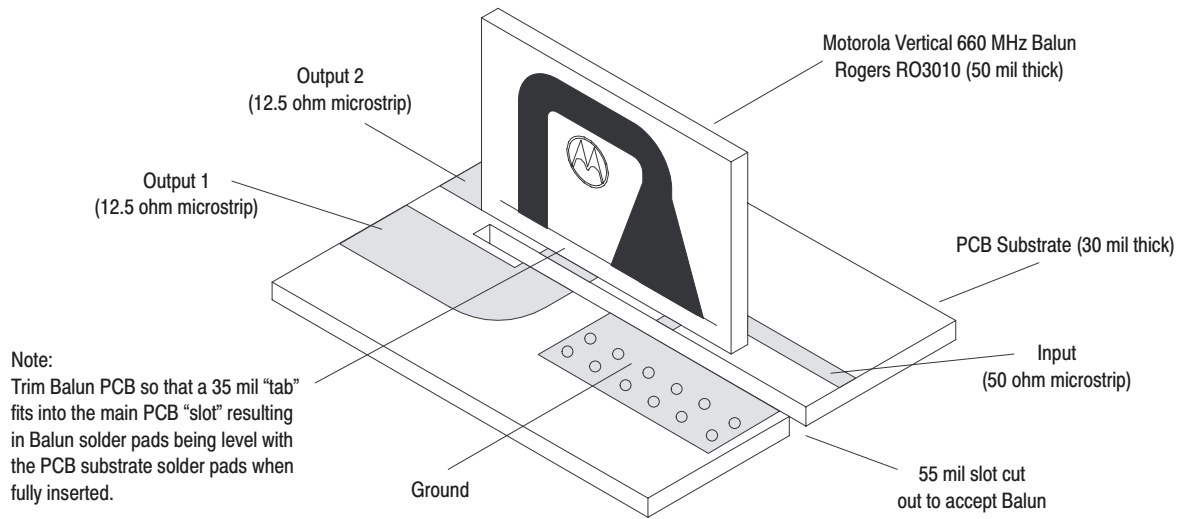

Figure 11. 470–860 MHz Broadband Component Layout

TYPICAL TWO-TONE BROADBAND CHARACTERISTICS

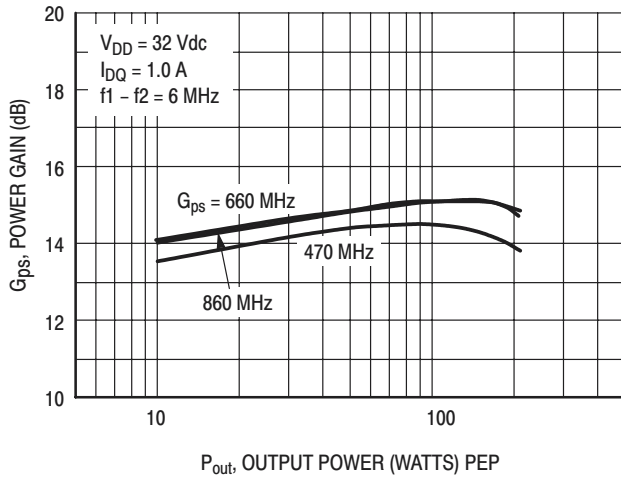

Figure 12. Power Gain versus Output Power

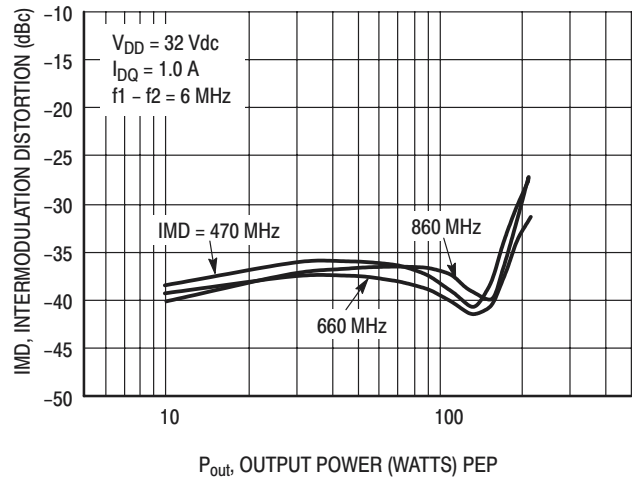

Figure 13. Intermodulation Distortion versus Output Power

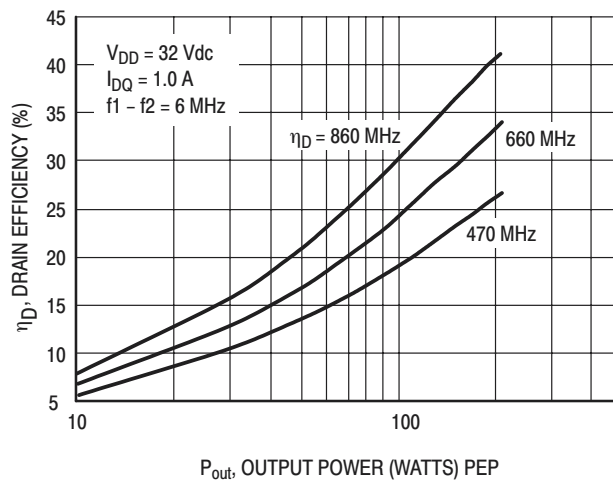
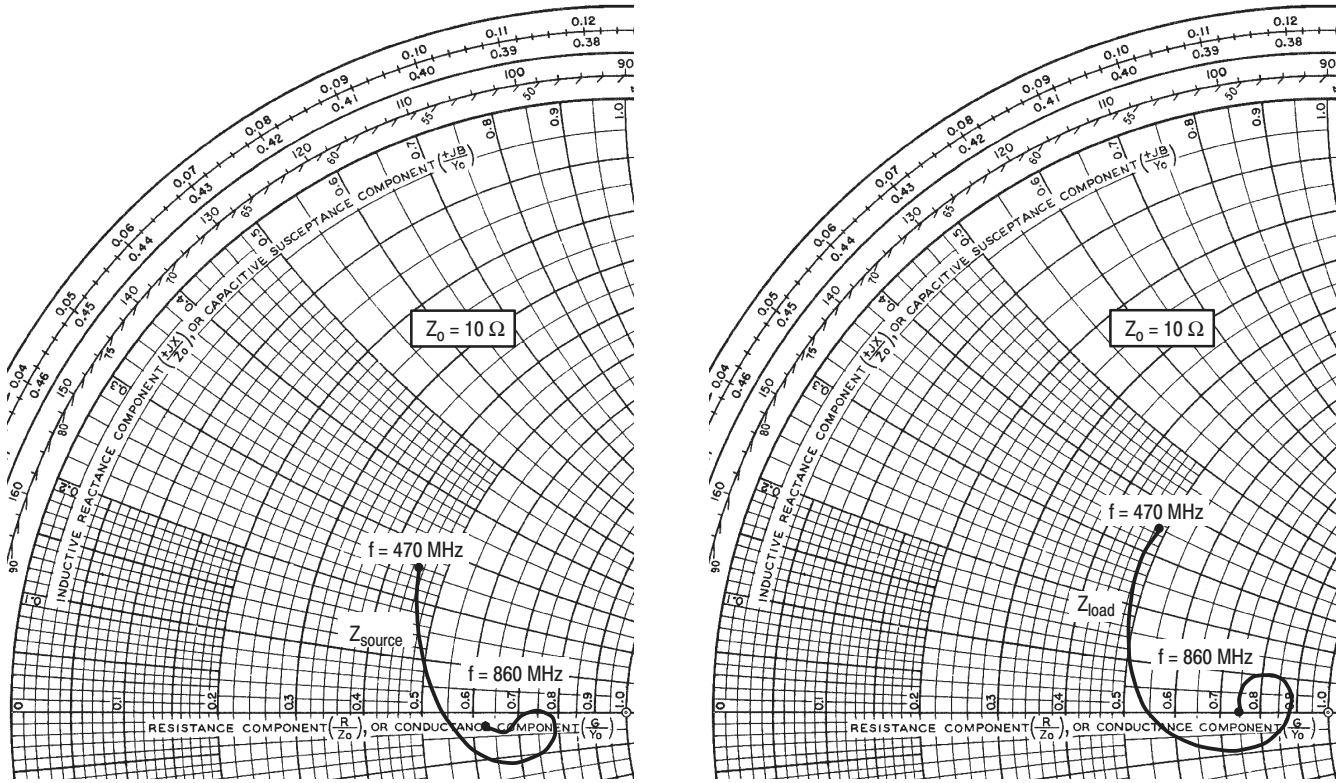

Figure 14. Drain Efficiency versus Output Power



$V_{DD} = 32\text{ V}$, $I_{DQ} = 1.0\text{ A}$, $P_{out} = 180\text{ W PEP}$

f MHz	Z_{source} Ω	Z_{load} Ω
470	$4.46 + j2.57$	$4.88 + j3.50$
560	$6.40 - j1.06$	$5.45 + j0.07$
660	$7.84 - j0.14$	$8.13 - j0.73$
760	$6.67 - j0.46$	$8.27 + j1.00$
860	$6.25 - j0.31$	$7.52 - j0.02$

Z_{source} = Test circuit impedance as measured from gate to gate, balanced configuration.

Z_{load} = Test circuit impedance as measured from drain to drain, balanced configuration.

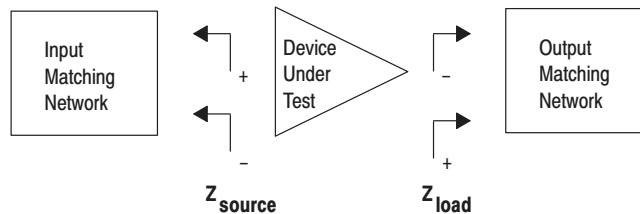
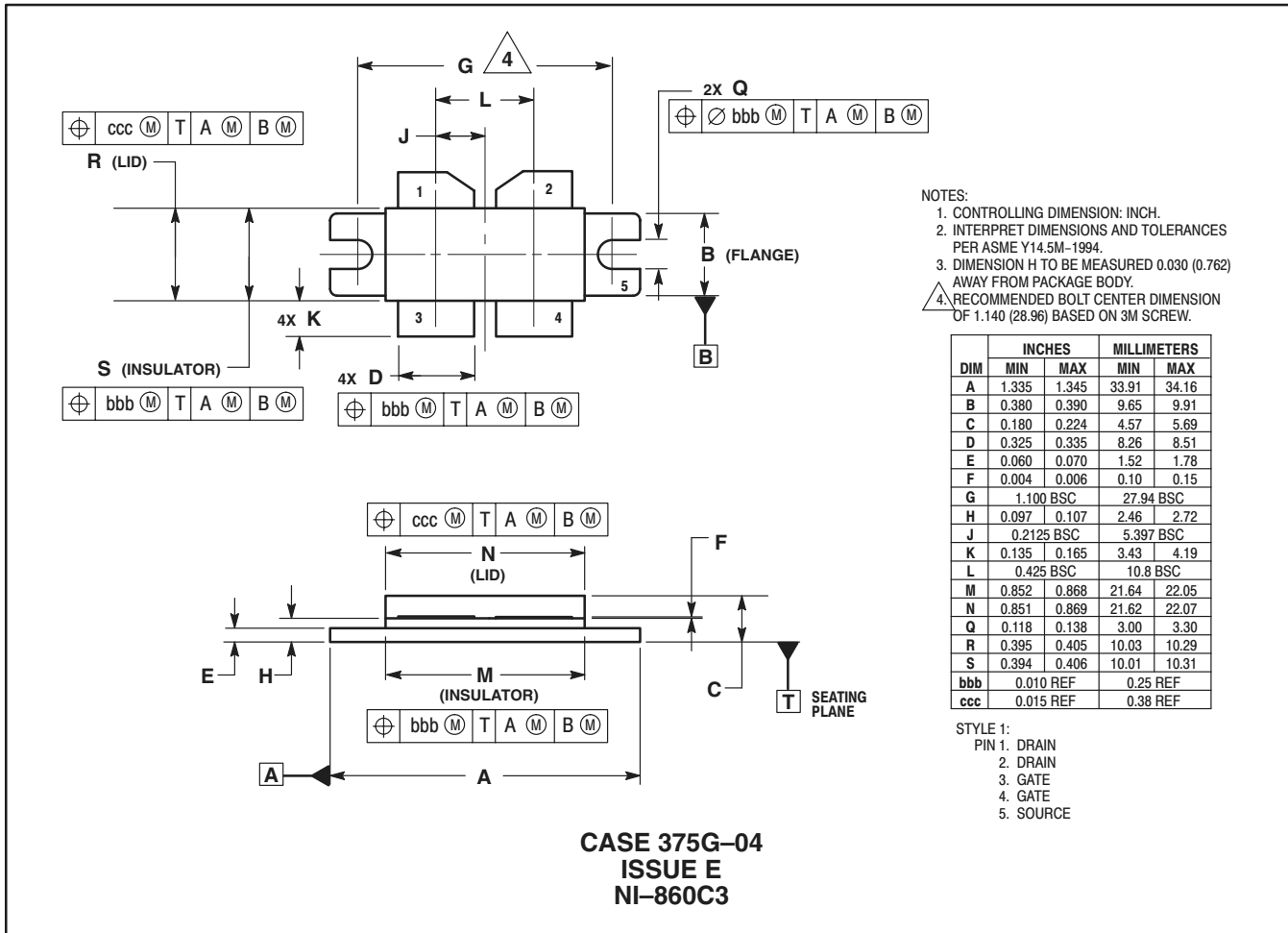

Figure 15. Broadband Series Equivalent Input and Output Impedance

PACKAGE DIMENSIONS



Motorola reserves the right to make changes without further notice to any products herein. Motorola makes no warranty, representation or guarantee regarding the suitability of its products for any particular purpose, nor does Motorola assume any liability arising out of the application or use of any product or circuit, and specifically disclaims any and all liability, including without limitation consequential or incidental damages. "Typical" parameters which may be provided in Motorola data sheets and/or specifications can and do vary in different applications and actual performance may vary over time. All operating parameters, including "Typicals" must be validated for each customer application by customer's technical experts. Motorola does not convey any license under its patent rights nor the rights of others. Motorola products are not designed, intended, or authorized for use as components in systems intended for surgical implant into the body, or other applications intended to support or sustain life, or for any other application in which the failure of the Motorola product could create a situation where personal injury or death may occur. Should Buyer purchase or use Motorola products for any such unintended or unauthorized application, Buyer shall indemnify and hold Motorola and its officers, employees, subsidiaries, affiliates, and distributors harmless against all claims, costs, damages, and expenses, and reasonable attorney fees arising out of, directly or indirectly, any claim of personal injury or death associated with such unintended or unauthorized use, even if such claim alleges that Motorola was negligent regarding the design or manufacture of the part. Motorola, Inc. is an Equal Opportunity/Affirmative Action Employer. MOTOROLA and the Motorola logo are registered in the US Patent & Trademark Office. All other product or service names are the property of their respective owners.

© Motorola, Inc. 2002.

How to reach us:

USA/EUROPE/Locations Not Listed: Motorola Literature Distribution; P.O. Box 5405, Denver, Colorado 80217. 1-303-675-2140 or 1-800-441-2447

JAPAN: Motorola Japan Ltd.; SPS, Technical Information Center, 3-20-1, Minami-Azabu, Minato-ku, Tokyo 106-8573 Japan. 81-3-3440-3569

ASIA/PACIFIC: Motorola Semiconductors H.K. Ltd.; Silicon Harbour Centre, 2 Dai King Street, Tai Po Industrial Estate, Tai Po, N.T., Hong Kong. 852-26668334

Technical Information Center: 1-800-521-6274

HOME PAGE: <http://www.motorola.com/semiconductors/>



This datasheet has been download from:

www.datasheetcatalog.com

Datasheets for electronics components.