

RF Power Field Effect Transistors

N-Channel Enhancement-Mode Lateral MOSFETs

Designed for CDMA base station applications with frequencies from 1930 to 1990 MHz. Suitable for CDMA and multicarrier amplifier applications. To be used in Class AB and Class C for PCN-PCS/cellular radio and WLL applications.

- Typical Single-Carrier W-CDMA Performance: $V_{DD} = 28$ Volts, $I_{DQ} = 1250$ mA, $P_{out} = 40$ Watts Avg., Full Frequency Band, 3GPP Test Model 1, 64 DPCH with 50% Clipping, Channel Bandwidth = 3.84 MHz, Input Signal PAR = 7.5 dB @ 0.01% Probability on CCDF.
 Power Gain — 20 dB
 Drain Efficiency — 30%
 Device Output Signal PAR — 6 dB @ 0.01% Probability on CCDF
 ACPR @ 5 MHz Offset — -36 dBc in 3.84 MHz Channel Bandwidth
- Capable of Handling 10:1 VSWR, @ 32 Vdc, 1960 MHz, 130 Watts CW Output Power
- P_{out} @ 1 dB Compression Point ≥ 130 Watts CW

Features

- 100% PAR Tested for Guaranteed Output Power Capability
- Characterized with Series Equivalent Large-Signal Impedance Parameters
- Internally Matched for Ease of Use
- Integrated ESD Protection
- Greater Negative Gate-Source Voltage Range for Improved Class C Operation
- RoHS Compliant
- In Tape and Reel. R3 Suffix = 250 Units per 56 mm, 13 inch Reel.

MD7P19130HR3
MD7P19130HSR3

1930-1990 MHz, 40 W AVG., 28 V
SINGLE W-CDMA
LATERAL N-CHANNEL
RF POWER MOSFETs

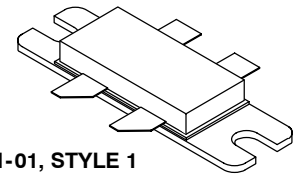

CASE 465M-01, STYLE 1
NI-780-4
MD7P19130HR3

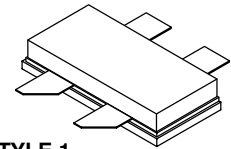

CASE 465H-02, STYLE 1
NI-780S-4
MD7P19130HSR3

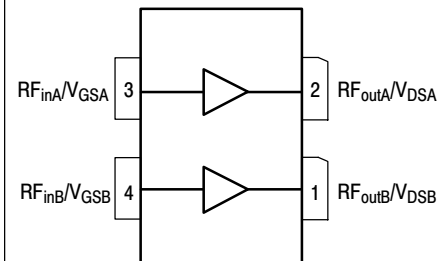

(Top View)

Figure 1. Pin Connections

Table 1. Maximum Ratings

Rating	Symbol	Value	Unit
Drain-Source Voltage	V_{DSS}	-0.5, +65	Vdc
Gate-Source Voltage	V_{GS}	-6.0, +10	Vdc
Operating Voltage	V_{DD}	32, +0	Vdc
Storage Temperature Range	T_{stg}	- 65 to +150	°C
Case Operating Temperature	T_C	150	°C
Operating Junction Temperature (1,2)	T_J	225	°C

1. Continuous use at maximum temperature will affect MTTF.
2. MTTF calculator available at <http://www.freescale.com/rtf>. Select Software & Tools/Development Tools/Calculators to access MTTF calculators by product.

Table 2. Thermal Characteristics

Characteristic	Symbol	Value (1,2)	Unit
Thermal Resistance, Junction to Case Case Temperature 80°C, 130 W CW Case Temperature 75°C, 40 W CW	$R_{\theta JC}$	0.31 0.36	°C/W

Table 3. ESD Protection Characteristics

Test Methodology	Class
Human Body Model (per JESD22-A114)	1C (Minimum)
Machine Model (per EIA/JESD22-A115)	A (Minimum)
Charge Device Model (per JESD22-C101)	IV (Minimum)

Table 4. Electrical Characteristics ($T_C = 25^\circ\text{C}$ unless otherwise noted)

Characteristic	Symbol	Min	Typ	Max	Unit
----------------	--------	-----	-----	-----	------

Off Characteristics ⁽³⁾

Zero Gate Voltage Drain Leakage Current ($V_{DS} = 65 \text{ Vdc}$, $V_{GS} = 0 \text{ Vdc}$)	I_{DSS}	—	—	10	μAdc
Zero Gate Voltage Drain Leakage Current ($V_{DS} = 28 \text{ Vdc}$, $V_{GS} = 0 \text{ Vdc}$)	I_{DSS}	—	—	1	μAdc
Gate-Source Leakage Current ($V_{GS} = 5 \text{ Vdc}$, $V_{DS} = 0 \text{ Vdc}$)	I_{GSS}	—	—	1	μAdc

On Characteristics ⁽³⁾

Gate Threshold Voltage ($V_{DS} = 10 \text{ Vdc}$, $I_D = 316 \mu\text{Adc}$)	$V_{GS(th)}$	1.2	2	2.7	Vdc
Gate Quiescent Voltage ($V_{DD} = 28 \text{ Vdc}$, $I_D = 1250 \text{ mAdc}$, Measured in Functional Test)	$V_{GS(Q)}$	1.9	2.7	3.4	Vdc
Drain-Source On-Voltage ($V_{GS} = 10 \text{ Vdc}$, $I_D = 3.16 \text{ Adc}$)	$V_{DS(on)}$	0.1	0.2	0.3	Vdc

Dynamic Characteristics ^(3,4)

Reverse Transfer Capacitance ($V_{DS} = 28 \text{ Vdc} \pm 30 \text{ mV(rms)ac}$ @ 1 MHz, $V_{GS} = 0 \text{ Vdc}$)	C_{rss}	—	1.2	—	pF
Output Capacitance ($V_{DS} = 28 \text{ Vdc} \pm 30 \text{ mV(rms)ac}$ @ 1 MHz, $V_{GS} = 0 \text{ Vdc}$)	C_{oss}	—	586	—	pF
Input Capacitance ($V_{DS} = 28 \text{ Vdc}$, $V_{GS} = 0 \text{ Vdc} \pm 30 \text{ mV(rms)ac}$ @ 1 MHz)	C_{iss}	—	348	—	pF

Functional Tests ⁽³⁾ (In Freescale Test Fixture, 50 ohm system) $V_{DD} = 28 \text{ Vdc}$, $I_{DQ} = 1250 \text{ mA}$, $P_{out} = 40 \text{ W Avg.}$, $f = 1932.5 \text{ MHz}$ and $f = 1987.5 \text{ MHz}$, Single-Carrier W-CDMA, 3GPP Test Model 1, 64 DPCH, 50% Clipping, Input Signal PAR = 7.5 dB @ 0.01% Probability on CCDF. ACPR measured in 3.84 MHz Channel Bandwidth @ $\pm 5 \text{ MHz}$ Offset.

Power Gain	G_{ps}	18.5	20	21.5	dB
Drain Efficiency	η_D	27	30	—	%
Output Peak-to-Average Ratio @ 0.01% Probability on CCDF	PAR	5.6	6	—	dB
Adjacent Channel Power Ratio	ACPR	—	-36	-32.5	dBc
Input Return Loss	IRL	—	-16	-7	dB

1. MTTF calculator available at <http://www.freescale.com/rtf>. Select Software & Tools/Development Tools/Calculators to access MTTF calculators by product.
2. Refer to AN1955, *Thermal Measurement Methodology of RF Power Amplifiers*. Go to <http://www.freescale.com/rtf>. Select Documentation/Application Notes - AN1955.
3. Measurement made with device in single-ended configuration.
4. Part internally matched both on input and output.

(continued)

Table 4. Electrical Characteristics ($T_C = 25^\circ\text{C}$ unless otherwise noted) (continued)

Characteristic	Symbol	Min	Typ	Max	Unit
Typical Performances (In Freescale Test Fixture, 50 ohm system) $V_{DD} = 28\text{ Vdc}$, $I_{DQ} = 1250\text{ mA}$, 1930-1990 MHz Bandwidth					
P_{out} @ 1 dB Compression Point, CW	P1dB	—	130	—	W
Gain Flatness in 60 MHz Bandwidth @ $P_{out} = 40\text{ W Avg.}$	G_F	—	0.3	—	dB
Average Deviation from Linear Phase in 60 MHz Bandwidth @ $P_{out} = 130\text{ W CW}$	Φ	—	0.5	—	$^\circ$
Average Group Delay @ $P_{out} = 130\text{ W CW}$, $f = 1960\text{ MHz}$	Delay	—	2.3	—	ns
Part-to-Part Insertion Phase Variation @ $P_{out} = 130\text{ W CW}$, $f = 1960\text{ MHz}$, Six Sigma Window	$\Delta\Phi$	—	80	—	$^\circ$
Gain Variation over Temperature (-30°C to $+85^\circ\text{C}$)	ΔG	—	0.016	—	dB/ $^\circ\text{C}$
Output Power Variation over Temperature (-30°C to $+85^\circ\text{C}$)	$\Delta P1dB$	—	0.01	—	dBm/ $^\circ\text{C}$

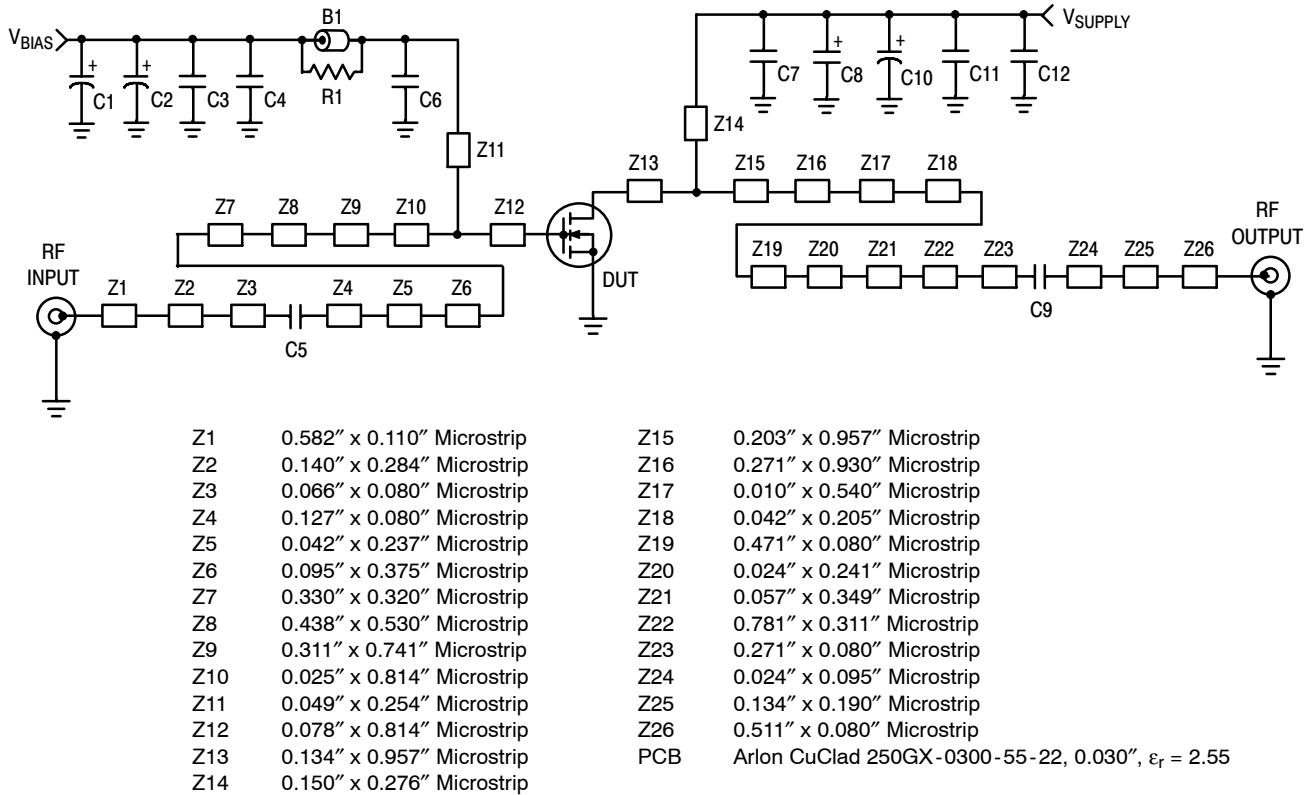

Figure 2. MD7P19130HR3(HSR3) Test Circuit Schematic

Table 5. MD7P19130HR3(HSR3) Test Circuit Component Designations and Values

Part	Description	Part Number	Manufacturer
B1	Short Ferrite Bead	2743019447 ROP50	Fair-Rite
C1	47 μ F, 50 V Electrolytic Capacitor	476KXM063M	Illinois Cap.
C2	100 μ F, 50 V Electrolytic Capacitor	T491C105K050AT	Kemet
C3	1.0 μ F Chip Capacitor	ATC100B102JT50XT	ATC
C4, C12	0.1 μ F Chip Capacitors	CDR33BX104AKYS	Kemet
C5, C9	11 pF Chip Capacitors	ATC100B110JT500XT	ATC
C6	13 pF Chip Capacitor	ATC100B130JT500XT	ATC
C7	8.2 pF Chip Capacitor	ATC100B8R2JT500XT	ATC
C8	22 μ F, 35 V Tantalum Capacitor	T491C226K035AT	Kemet
C10	470 μ F, 63 V Electrolytic Capacitor	477KXM063M	Illinois Cap.
C11	10 μ F, 50 V Chip Capacitor	GRM55DR61H106KA88B	Murata
R1	10 Ω , 1/4 W Chip Resistor	CRCW120610R0FKEA	Vishay

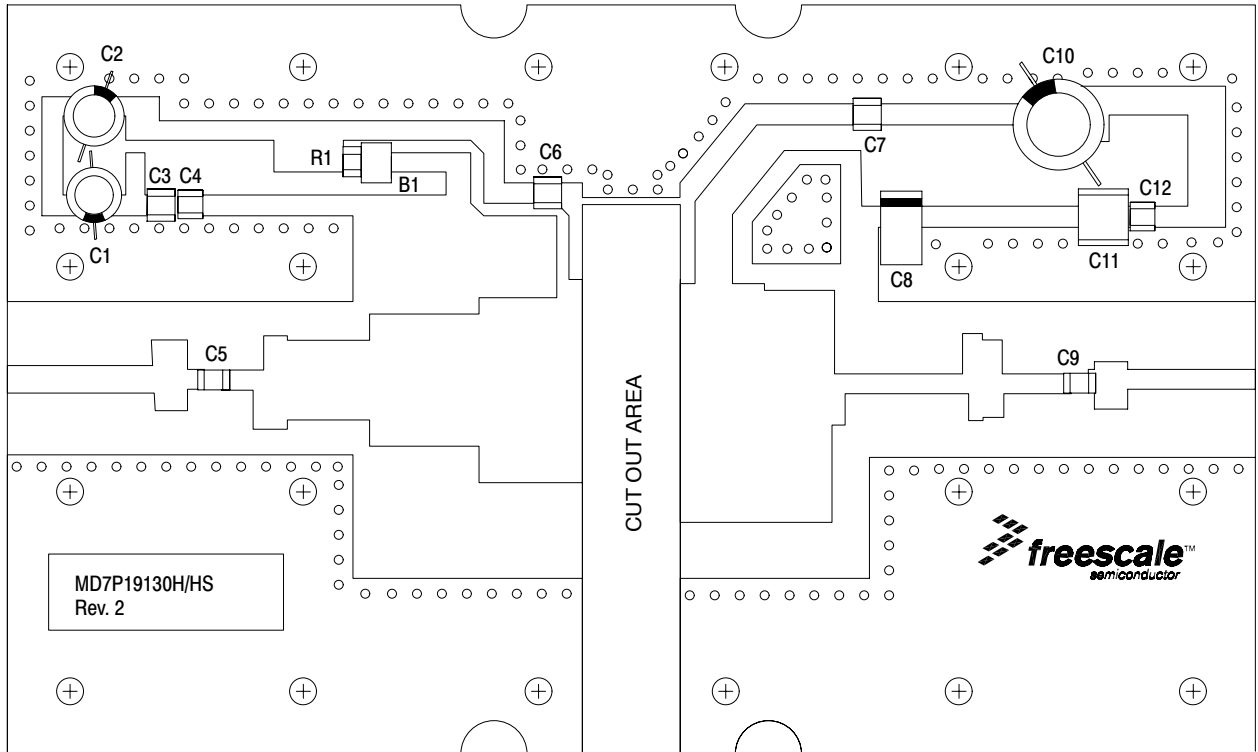

Figure 3. MD7P19130HR3(HSR3) Test Circuit Component Layout

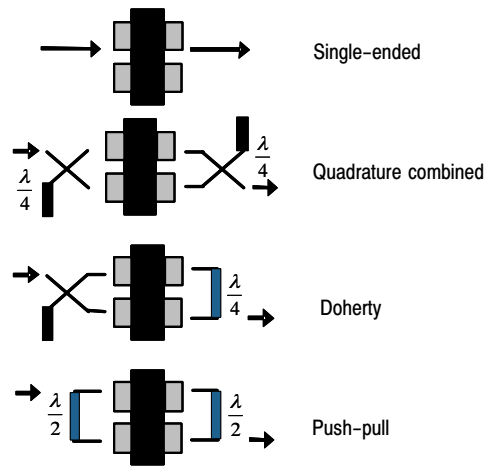

Figure 4. Possible Circuit Topologies

TYPICAL CHARACTERISTICS

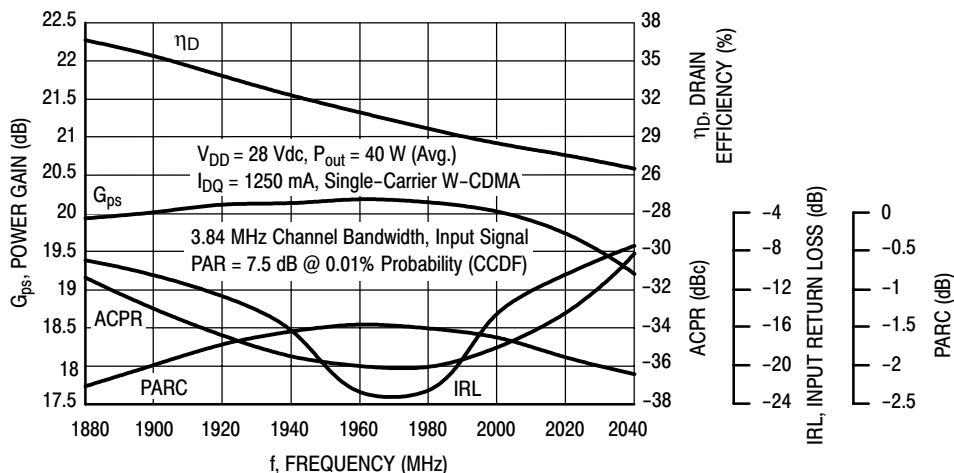

Figure 5. Output Peak-to-Average Ratio Compression (PARC) Broadband Performance @ P_{out} = 40 Watts Avg.

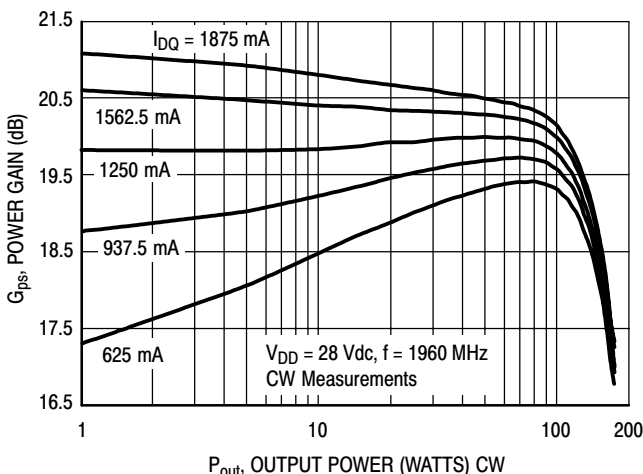

Figure 6. CW Power Gain versus Output Power

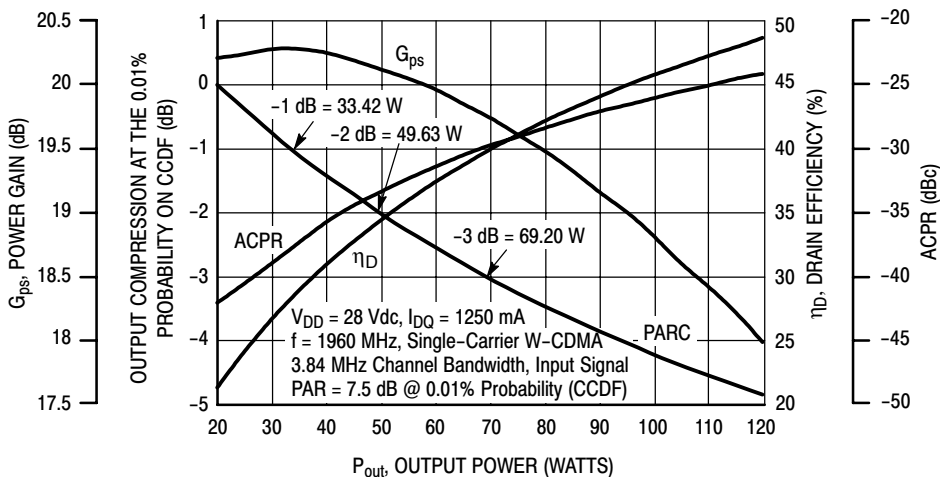

Figure 7. Output Peak-to-Average Ratio Compression (PARC) versus Output Power

TYPICAL CHARACTERISTICS

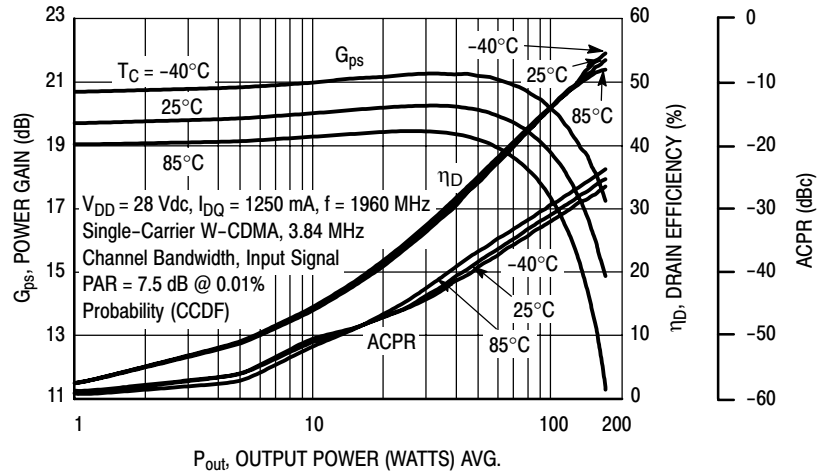

Figure 8. Single-Carrier W-CDMA Power Gain, Drain Efficiency and ACPR versus Output Power

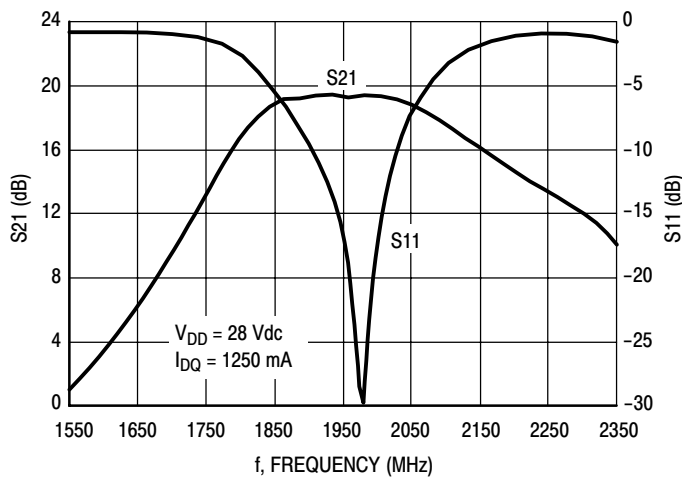
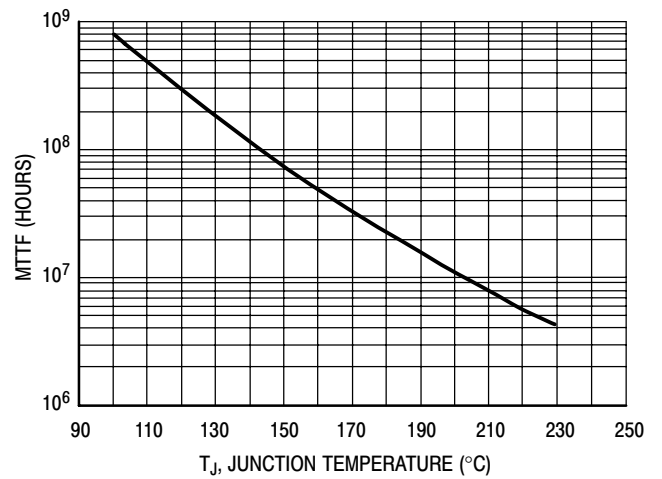

Figure 9. Broadband Frequency Response



This above graph displays calculated MTTF in hours when the device is operated at $V_{DD} = 28$ Vdc, $P_{out} = 40$ W Avg., and $\eta_D = 30\%$.

MTTF calculator available at <http://www.freescale.com/rf>. Select Software & Tools/Development Tools/Calculators to access MTTF calculators by product.

Figure 10. MTTF versus Junction Temperature

W-CDMA TEST SIGNAL

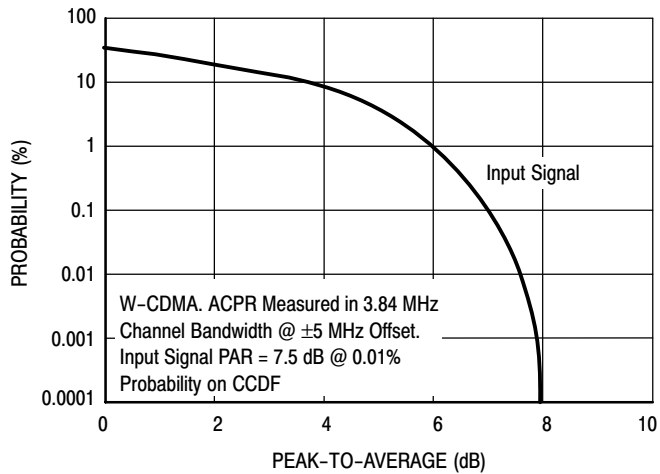

Figure 11. CCDF W-CDMA 3GPP, Test Model 1, 64 DPCH, 50% Clipping, Single-Carrier Test Signal

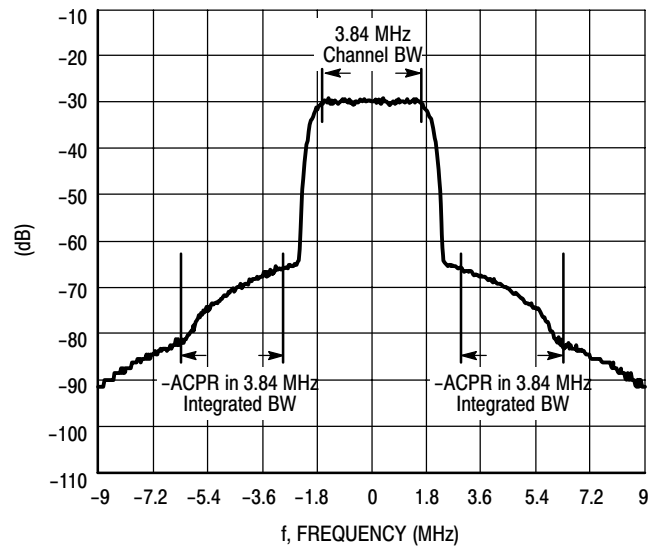
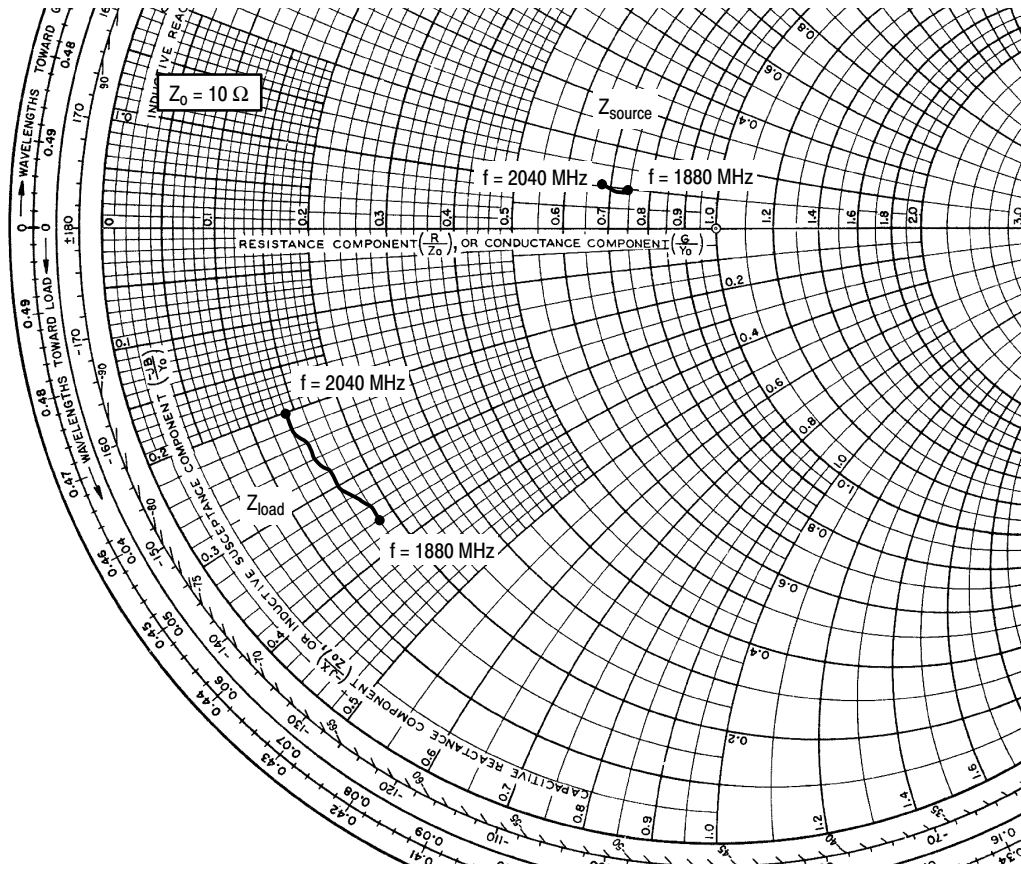

Figure 12. Single-Carrier W-CDMA Spectrum



$V_{DD} = 28 \text{ Vdc}$, $I_{DQ} = 1250 \text{ mA}$, $P_{out} = 40 \text{ W Avg.}$

f MHz	Z_{source} Ω	Z_{load} Ω
1880	$7.37 + j1.00$	$1.84 - j3.56$
1900	$7.33 + j0.96$	$1.78 - j3.37$
1920	$7.27 + j0.93$	$1.72 - j3.17$
1940	$7.19 + j0.90$	$1.64 - j2.98$
1960	$7.07 + j0.89$	$1.55 - j2.79$
1980	$6.93 + j0.97$	$1.48 - j2.55$
2000	$6.89 + j1.04$	$1.46 - j2.36$
2020	$6.83 + j1.07$	$1.44 - j2.20$
2040	$6.75 + j1.12$	$1.40 - j2.02$

Z_{source} = Test circuit impedance as measured from gate to ground.

Z_{load} = Test circuit impedance as measured from drain to ground.

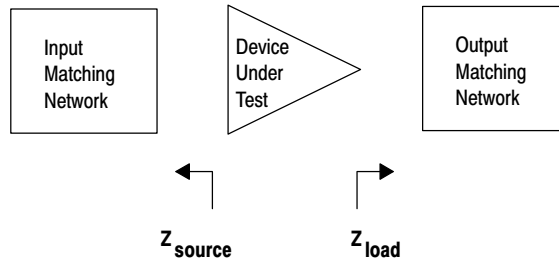
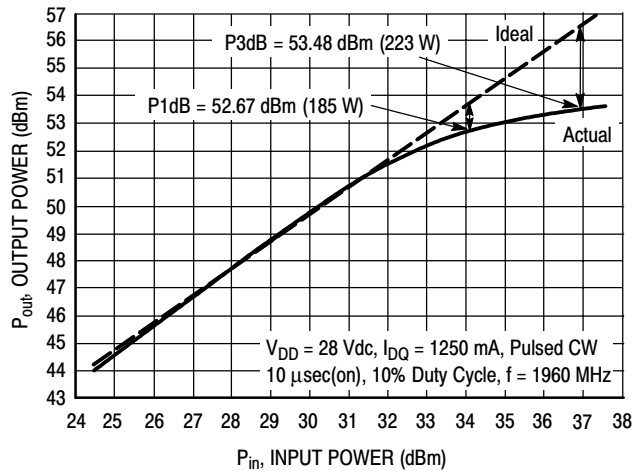

Figure 13. Series Equivalent Source and Load Impedance

ALTERNATIVE PEAK TUNE LOAD PULL CHARACTERISTICS



NOTE: Load Pull Test Fixture Tuned for Peak P1dB Output Power @ 28 V

Test Impedances per Compression Level

	Z_{source} Ω	Z_{load} Ω
P1dB	7.15 - j1.86	0.84 - j2.99

Figure 14. Pulsed CW Output Power versus Input Power @ 28 V

PACKAGE DIMENSIONS

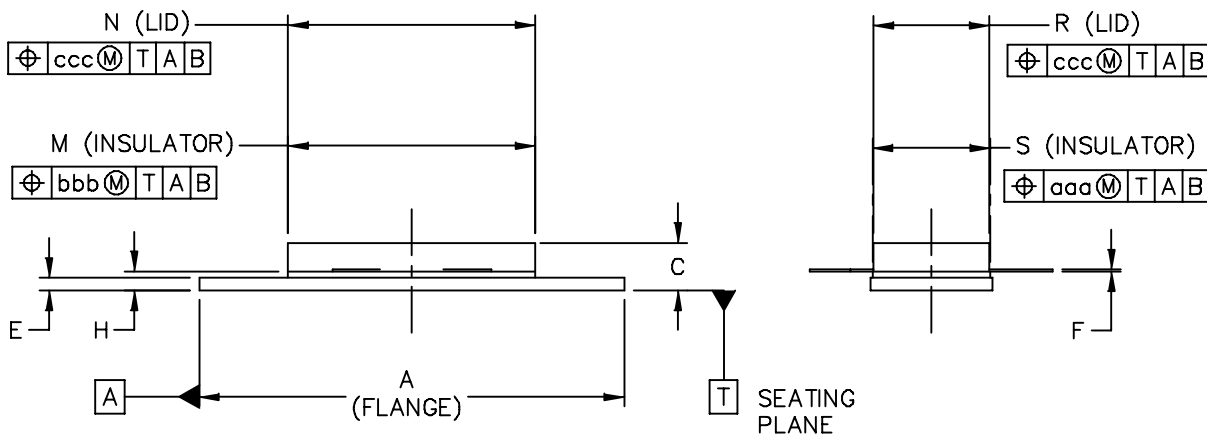
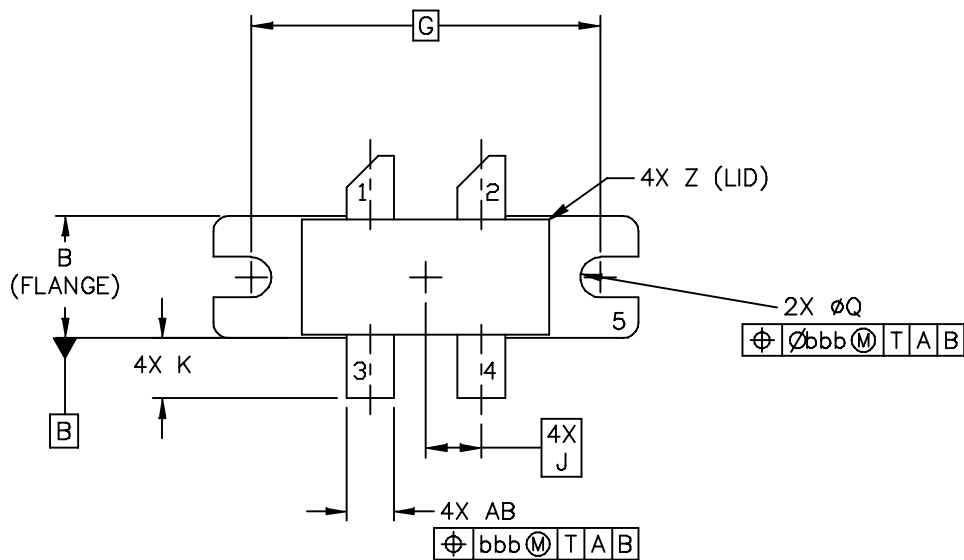

© FREESCALE SEMICONDUCTOR, INC. ALL RIGHTS RESERVED.	MECHANICAL OUTLINE	PRINT VERSION NOT TO SCALE	
TITLE: NI 780-4	DOCUMENT NO: 98ASA10793D		REV: 0
	CASE NUMBER: 465M-01		27 MAR 2007
	STANDARD: NON-JEDEC		

NOTES:

1. DIMENSIONING AND TOLERANCING PER ANSI Y14.5M-1994.
2. CONTROLLING DIMENSION: INCH.
3. DIMENSION H IS MEASURED .030 (0.762) AWAY FROM PACKAGE BODY.

STYLE 1:

- PIN
1. DRAIN
 2. DRAIN
 3. GATE
 4. GATE
 5. SOURCE

DIM	INCH		MILLIMETER		DIM	INCH		MILLIMETER	
	MIN	MAX	MIN	MAX		MIN	MAX	MIN	MAX
A	1.335	1.345	33.91	34.16	R	.365	.375	9.27	9.53
B	.380	.390	9.65	9.91	S	.365	.375	9.27	9.52
C	.125	.170	3.18	4.32	U		.040		1.02
E	.035	.045	0.89	1.14	Z		.030		0.76
F	.003	.006	0.08	0.15	AB	.145	.155	3.68	3.94
G	1.100 BSC		27.94 BSC						
H	.057	.067	1.45	1.7	aaa		.005		0.127
J	.175 BSC		4.44 BSC		bbb		.010		0.254
K	.170	.210	4.32	5.33	ccc		.015		0.381
M	.774	.786	19.61	20.02					
N	.772	.788	19.61	20.02					
Q	Ø.118	Ø.138	Ø3	Ø3.51					
© FREESCALE SEMICONDUCTOR, INC. ALL RIGHTS RESERVED.			MECHANICAL OUTLINE			PRINT VERSION NOT TO SCALE			
TITLE: NI 780-4					DOCUMENT NO: 98ASA10793D			REV: 0	
					CASE NUMBER: 465M-01			27 MAR 2007	
					STANDARD: NON-JEDEC				

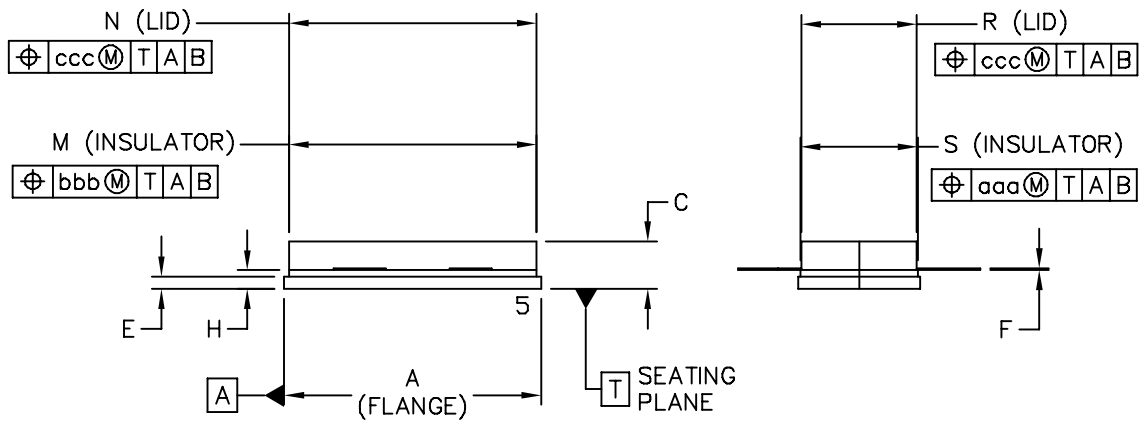
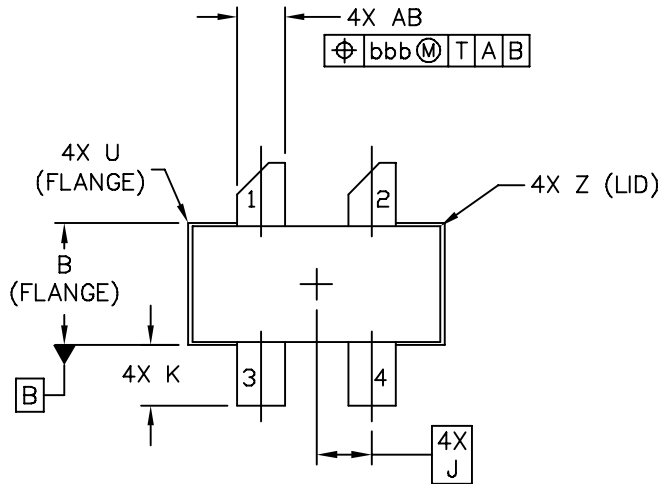

© FREESCALE SEMICONDUCTOR, INC. ALL RIGHTS RESERVED.	MECHANICAL OUTLINE	PRINT VERSION NOT TO SCALE	
TITLE: NI 780S-4	DOCUMENT NO: 98ASA10718D	REV: A	
	CASE NUMBER: 465H-02	27 MAR 2007	
	STANDARD: NON-JEDEC		

NOTES:

1. DIMENSIONING AND TOLERANCING PER ANSI Y14.5M-1994.
2. CONTROLLING DIMENSION: INCH.
3. DELETED
4. DIMENSION H IS MEASURED .030 (0.762) AWAY FROM PACKAGE BODY.

STYLE 1:

- PIN 1. DRAIN
 2. DRAIN
 3. GATE
 4. GATE
 5. SOURCE

DIM	INCH		MILLIMETER		DIM	INCH		MILLIMETER	
	MIN	MAX	MIN	MAX		MIN	MAX	MIN	MAX
A	.805	.815	20.45	20.7	U		.040		1.02
B	.380	.390	9.65	9.91	Z		.030		0.76
C	.125	.170	3.18	4.32	AB	.145	.155	3.68	- 3.94
E	.035	.045	0.89	1.14					
F	.003	.006	0.08	0.15	aaa		.005		0.127
H	.057	.067	1.45	1.7	bbb		.010		0.254
J	.175 BSC		4.44 BSC		ccc		.015		0.381
K	.170	.210	4.32	5.33					
M	.774	.786	19.61	20.02					
N	.772	.788	19.61	20.02					
R	.365	.375	9.27	9.53					
S	.365	.375	9.27	9.52					
© FREESCALE SEMICONDUCTOR, INC. ALL RIGHTS RESERVED.			MECHANICAL OUTLINE			PRINT VERSION NOT TO SCALE			
TITLE: NI 780S-4					DOCUMENT NO: 98ASA10718D			REV: A	
					CASE NUMBER: 465H-02			27 MAR 2007	
					STANDARD: NON-JEDEC				

PRODUCT DOCUMENTATION

Refer to the following documents to aid your design process.

Application Notes

- AN1955: Thermal Measurement Methodology of RF Power Amplifiers

Engineering Bulletins

- EB212: Using Data Sheet Impedances for RF LDMOS Devices

REVISION HISTORY

The following table summarizes revisions to this document.

Revision	Date	Description
0	May 2008	<ul style="list-style-type: none">• Initial Release of Data Sheet

How to Reach Us:

Home Page:

www.freescale.com

Web Support:

<http://www.freescale.com/support>

USA/Europe or Locations Not Listed:

Freescale Semiconductor, Inc.
Technical Information Center, EL516
2100 East Elliot Road
Tempe, Arizona 85284
+1-800-521-6274 or +1-480-768-2130
www.freescale.com/support

Europe, Middle East, and Africa:

Freescale Halbleiter Deutschland GmbH
Technical Information Center
Schatzbogen 7
81829 Muenchen, Germany
+44 1296 380 456 (English)
+46 8 52200080 (English)
+49 89 92103 559 (German)
+33 1 69 35 48 48 (French)
www.freescale.com/support

Japan:

Freescale Semiconductor Japan Ltd.
Headquarters
ARCO Tower 15F
1-8-1, Shimo-Meguro, Meguro-ku,
Tokyo 153-0064
Japan
0120 191014 or +81 3 5437 9125
support.japan@freescale.com

Asia/Pacific:

Freescale Semiconductor China Ltd.
Exchange Building 23F
No. 118 Jianguo Road
Chaoyang District
Beijing 100022
China
+86 010 5879 8000
support.asia@freescale.com

For Literature Requests Only:

Freescale Semiconductor Literature Distribution Center
P.O. Box 5405
Denver, Colorado 80217
1-800-441-2447 or 303-675-2140
Fax: 303-675-2150
LDCForFreescaleSemiconductor@hibbertgroup.com

Information in this document is provided solely to enable system and software implementers to use Freescale Semiconductor products. There are no express or implied copyright licenses granted hereunder to design or fabricate any integrated circuits or integrated circuits based on the information in this document.

Freescale Semiconductor reserves the right to make changes without further notice to any products herein. Freescale Semiconductor makes no warranty, representation or guarantee regarding the suitability of its products for any particular purpose, nor does Freescale Semiconductor assume any liability arising out of the application or use of any product or circuit, and specifically disclaims any and all liability, including without limitation consequential or incidental damages. "Typical" parameters that may be provided in Freescale Semiconductor data sheets and/or specifications can and do vary in different applications and actual performance may vary over time. All operating parameters, including "Typicals", must be validated for each customer application by customer's technical experts. Freescale Semiconductor does not convey any license under its patent rights nor the rights of others. Freescale Semiconductor products are not designed, intended, or authorized for use as components in systems intended for surgical implant into the body, or other applications intended to support or sustain life, or for any other application in which the failure of the Freescale Semiconductor product could create a situation where personal injury or death may occur. Should Buyer purchase or use Freescale Semiconductor products for any such unintended or unauthorized application, Buyer shall indemnify and hold Freescale Semiconductor and its officers, employees, subsidiaries, affiliates, and distributors harmless against all claims, costs, damages, and expenses, and reasonable attorney fees arising out of, directly or indirectly, any claim of personal injury or death associated with such unintended or unauthorized use, even if such claim alleges that Freescale Semiconductor was negligent regarding the design or manufacture of the part.

Freescale™ and the Freescale logo are trademarks of Freescale Semiconductor, Inc. All other product or service names are the property of their respective owners.

© Freescale Semiconductor, Inc. 2008. All rights reserved.

