

# RF Power Field Effect Transistors

## N-Channel Enhancement-Mode Lateral MOSFETs

Designed for W-CDMA base station applications with frequencies from 2110 to 2170 MHz. Suitable for TDMA, CDMA and multicarrier amplifier applications. To be used in Class AB for PCN-PCS/cellular radio, WLL and TD-SCDMA applications.

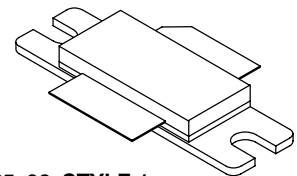
- Typical 2-carrier W-CDMA Performance for  $V_{DD} = 28$  Volts,  $I_{DQ} = 950$  mA,  $P_{out} = 23$  Watts Avg., Full Frequency Band, Channel Bandwidth = 3.84 MHz, PAR = 8.5 dB @ 0.01% Probability on CCDF.  
Power Gain — 15.9 dB  
Drain Efficiency — 27.6%  
IM3 @ 10 MHz Offset — -37 dBc in 3.84 MHz Channel Bandwidth  
ACPR @ 5 MHz Offset — -39.5 dBc in 3.84 MHz Channel Bandwidth
- Capable of Handling 10:1 VSWR, @ 28 Vdc, 2140 MHz, 100 Watts CW Output Power

### Features

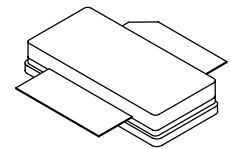
- Characterized with Series Equivalent Large-Signal Impedance Parameters
- Internally Matched for Ease of Use
- Qualified Up to a Maximum of 32  $V_{DD}$  Operation
- Integrated ESD Protection
- Designed for Lower Memory Effects and Wide Instantaneous Bandwidth Applications
- RoHS Compliant
- In Tape and Reel. R3 Suffix = 250 Units per 56 mm, 13 inch Reel.

**MRF6S21100HR3**  
**MRF6S21100HSR3**

**2110-2170 MHz, 23 W AVG., 28 V**  
**2 x W-CDMA**  
**LATERAL N-CHANNEL**  
**RF POWER MOSFETs**



**CASE 465-06, STYLE 1**  
**NI-780**  
**MRF6S21100HR3**



**CASE 465A-06, STYLE 1**  
**NI-780S**  
**MRF6S21100HSR3**

**Table 1. Maximum Ratings**

Rating	Symbol	Value	Unit
Drain-Source Voltage	$V_{DSS}$	-0.5, +68	Vdc
Gate-Source Voltage	$V_{GS}$	-0.5, +12	Vdc
Storage Temperature Range	$T_{stg}$	-65 to +150	°C
Case Operating Temperature	$T_C$	150	°C
Operating Junction Temperature	$T_J$	200	°C

**Table 2. Thermal Characteristics**

Characteristic	Symbol	Value (1,2)	Unit
Thermal Resistance, Junction to Case	$R_{\theta JC}$		°C/W
Case Temperature 80°C, 100 W CW		0.45	
Case Temperature 77°C, 23 W CW		0.52	

1. MTTF calculator available at <http://www.freescale.com/rf>. Select Tools/Software/Application Software/Calculators to access the MTTF calculators by product.
2. Refer to AN1955, *Thermal Measurement Methodology of RF Power Amplifiers*. Go to <http://www.freescale.com/rf>. Select Documentation/Application Notes - AN1955.

**Table 3. ESD Protection Characteristics**

Test Methodology	Class
Human Body Model (per JESD22-A114)	3A (Minimum)
Machine Model (per EIA/JESD22-A115)	A (Minimum)
Charge Device Model (per JESD22-C101)	IV (Minimum)

**Table 4. Electrical Characteristics** ( $T_C = 25^\circ\text{C}$  unless otherwise noted)

Characteristic	Symbol	Min	Typ	Max	Unit
----------------	--------	-----	-----	-----	------

**Off Characteristics**

Zero Gate Voltage Drain Leakage Current ( $V_{DS} = 68\text{ Vdc}$ , $V_{GS} = 0\text{ Vdc}$ )	$I_{DSS}$	—	—	10	$\mu\text{A}$
Zero Gate Voltage Drain Leakage Current ( $V_{DS} = 28\text{ Vdc}$ , $V_{GS} = 0\text{ Vdc}$ )	$I_{DSS}$	—	—	1	$\mu\text{A}$
Gate-Source Leakage Current ( $V_{GS} = 5\text{ Vdc}$ , $V_{DS} = 0\text{ Vdc}$ )	$I_{GSS}$	—	—	1	$\mu\text{A}$

**On Characteristics**

Gate Threshold Voltage ( $V_{DS} = 10\text{ Vdc}$ , $I_D = 250\ \mu\text{A}$ )	$V_{GS(th)}$	1	2	3	Vdc
Gate Quiescent Voltage ( $V_{DS} = 28\text{ Vdc}$ , $I_D = 950\text{ mA}$ )	$V_{GS(Q)}$	2	2.8	4	Vdc
Drain-Source On-Voltage ( $V_{GS} = 10\text{ Vdc}$ , $I_D = 2.2\text{ A}$ )	$V_{DS(on)}$	0.1	0.21	0.3	Vdc

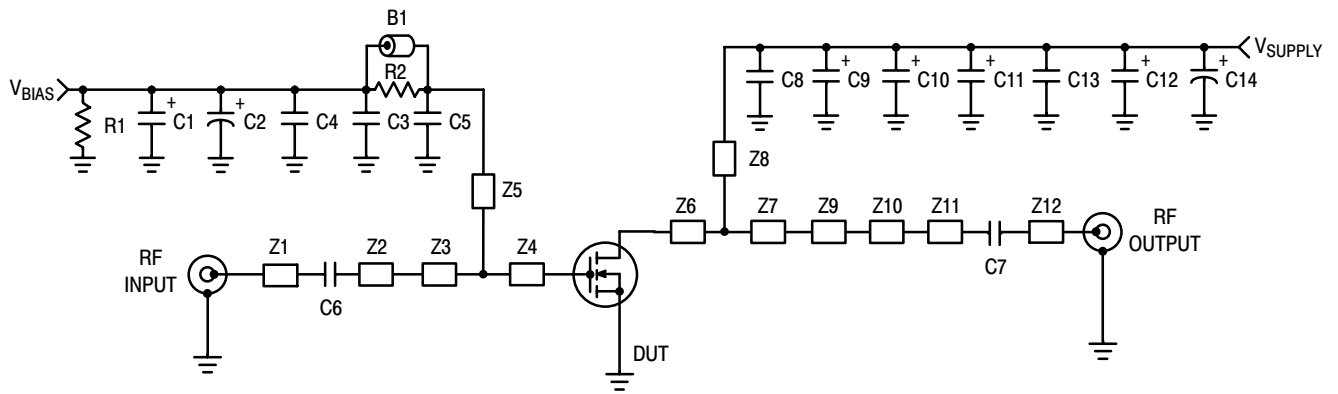
**Dynamic Characteristics** <sup>(1)</sup>

Reverse Transfer Capacitance ( $V_{DS} = 28\text{ Vdc} \pm 30\text{ mV(rms)}$ ac @ 1 MHz, $V_{GS} = 0\text{ Vdc}$ )	$C_{rss}$	—	1.5	—	pF
--	-----------	---	-----	---	----

**Functional Tests** (In Freescale Test Fixture, 50 ohm system)  $V_{DD} = 28\text{ Vdc}$ ,  $I_{DQ} = 950\text{ mA}$ ,  $P_{out} = 23\text{ W Avg.}$ ,  $f_1 = 2112.5\text{ MHz}$ ,  $f_2 = 2122.5\text{ MHz}$  and  $f_1 = 2157.5\text{ MHz}$ ,  $f_2 = 2167.5\text{ MHz}$ , 2-carrier W-CDMA, 3.84 MHz Channel Bandwidth Carriers, ACPR measured in 3.84 MHz Channel Bandwidth @  $\pm 5\text{ MHz}$  Offset. IM3 measured in 3.84 MHz Channel Bandwidth @  $\pm 10\text{ MHz}$  Offset. PAR = 8.5 dB @ 0.01% Probability on CCDF.

Power Gain	$G_{ps}$	14.5	15.9	17.5	dB
Drain Efficiency	$\eta_D$	26	27.6	—	%
Intermodulation Distortion	IM3	—	-37	-35	dBc
Adjacent Channel Power Ratio	ACPR	—	-39.5	-38	dBc
Input Return Loss	IRL	—	-16	-9	dB

1. Part is internally matched both on input and output.



Z1, Z12	1.250" x 0.084" Microstrip	Z7	0.320" x 0.880" Microstrip
Z2	1.070" x 0.084" Microstrip	Z8	0.120" x 0.820" Microstrip
Z3	0.330" x 0.800" Microstrip	Z9	0.035" x 0.320" Microstrip
Z4	0.093" x 0.800" Microstrip	Z10	0.335" x 0.200" Microstrip
Z5	1.255" x 0.040" Microstrip	Z11	0.650" x 0.084" Microstrip
Z6	0.160" x 0.880" Microstrip	PCB	Arlon GX-0300-55-22, 0.030", $\epsilon_r = 2.55$

**Figure 1. MRF6S21100HR3(SR3) Test Circuit Schematic**

**Table 5. MRF6S21100HR3(SR3) Test Circuit Component Designations and Values**

Part	Description	Part Number	Manufacturer
B1	Ferrite Bead	2743019447	Fair-Rite
C1	1.0 $\mu$ F, 50 V Tantalum Capacitor	T491C105M050AT	Kemet
C2	10 $\mu$ F, 50 V Electrolytic Capacitor	EEV-HB1H100P	Panasonic
C3	1000 pF 100B Chip Capacitor	ATC100B102JT500XT	ATC
C4, C13	0.1 $\mu$ F 100B Chip Capacitors	CDR33BX104AKWY	Kemet
C5	5.1 pF Chip Capacitor	ATC100B5R1JT500XT	ATC
C6, C7	15 pF Chip Capacitors	ATC100B150JT500XT	ATC
C8	6.8 pF Chip Capacitors	ATC100B6R8JT500XT	ATC
C9, C10, C11, C12	22 $\mu$ F, 35 V Tantalum Capacitors	T491X226K035AT	Kemet
C14	100 $\mu$ F, 50 V Electrolytic Capacitor	515D107M050BB6AE3	Vishay/Sprague
R1	1.0 k $\Omega$ , 1/8 W Chip Resistor	CRCW08051000FKTA	Vishay
R2	10 $\Omega$ , 1/8 W Chip Resistor	CRCW080510R0FKTA	Vishay

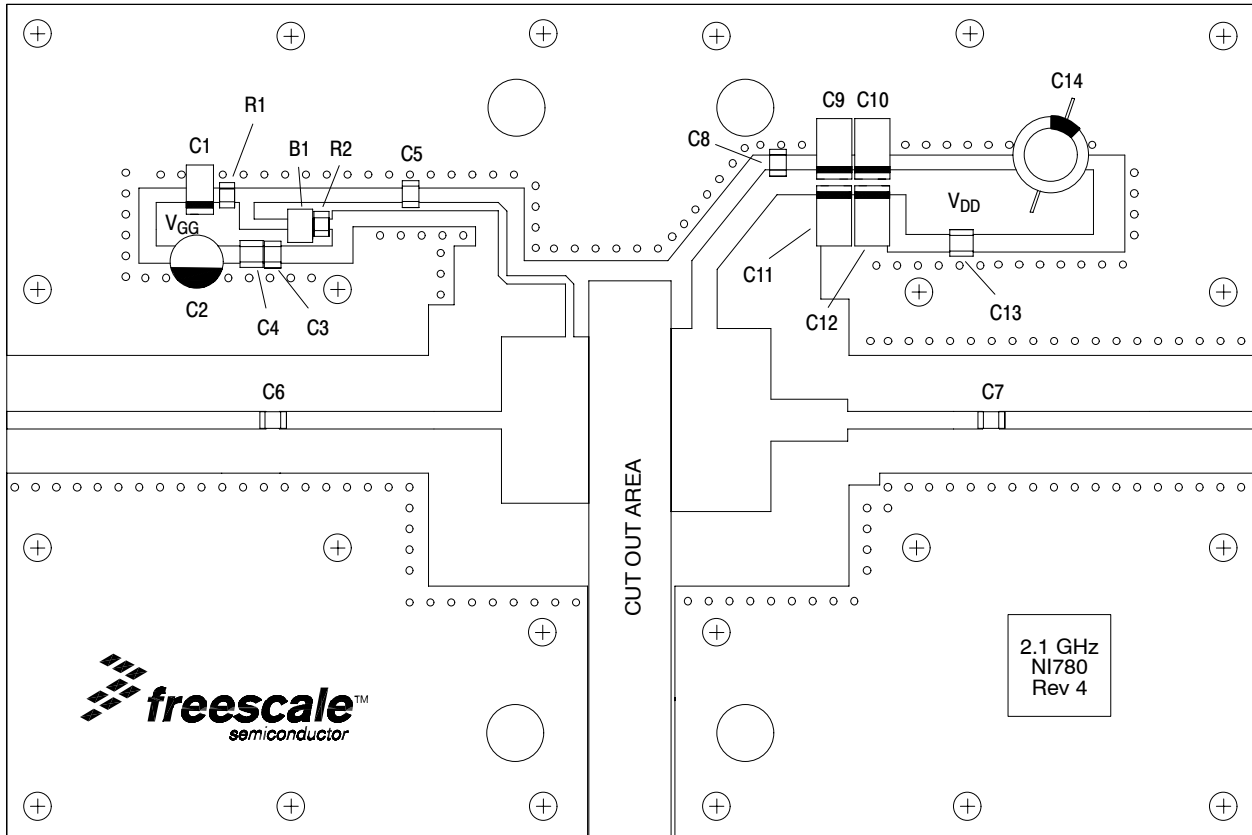


Figure 2. MRF6S21100HR3(SR3) Test Circuit Component Layout

## TYPICAL CHARACTERISTICS

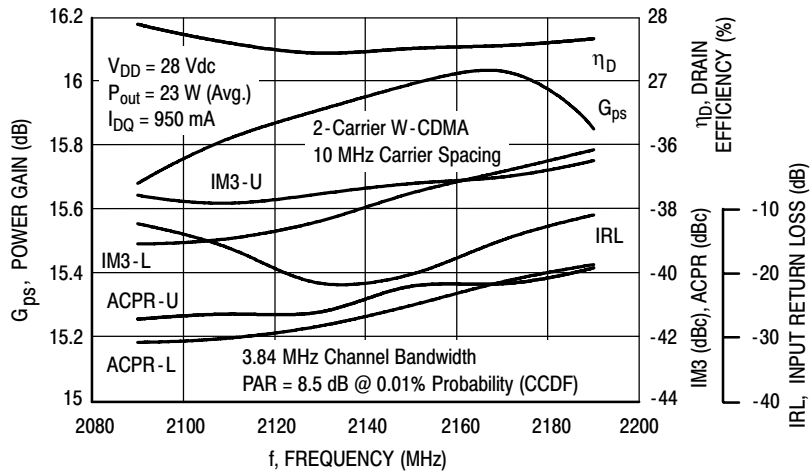


Figure 3. 2-Carrier W-CDMA Broadband Performance @  $P_{out} = 23$  Watts Avg.

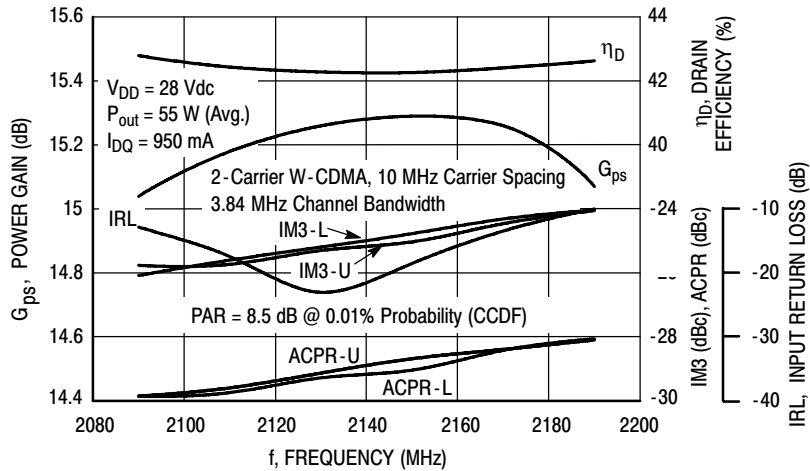


Figure 4. 2-Carrier W-CDMA Broadband Performance @  $P_{out} = 55$  Watts Avg.

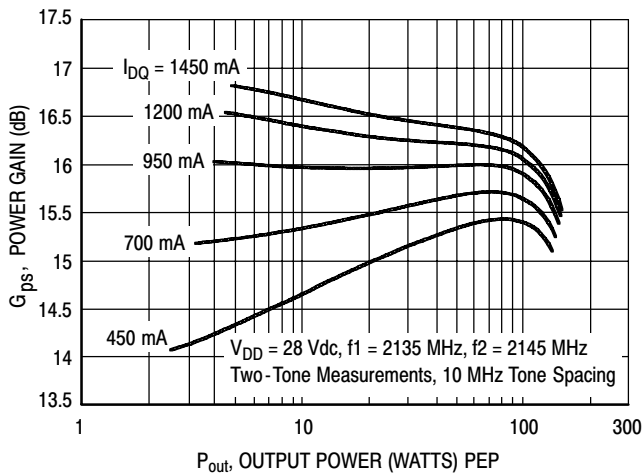


Figure 5. Two-Tone Power Gain versus Output Power

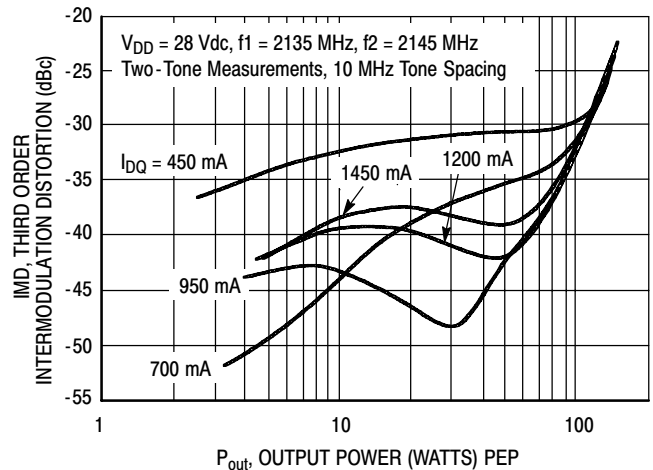
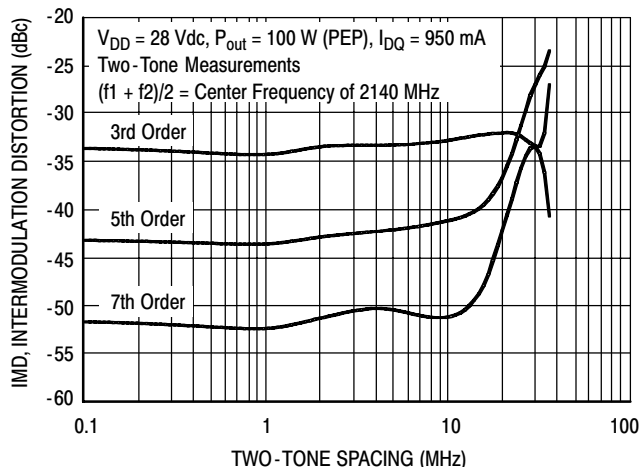
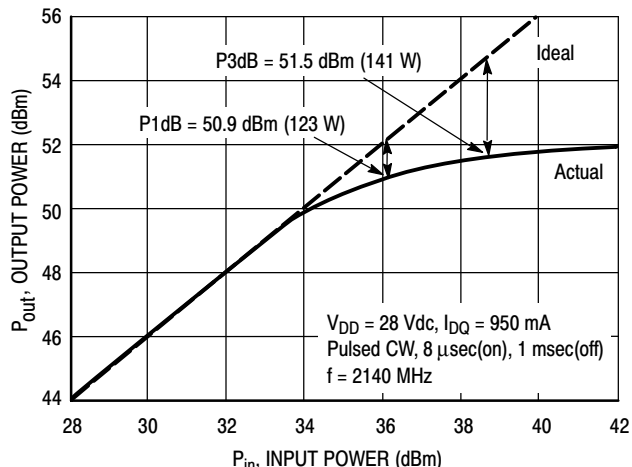


Figure 6. Third Order Intermodulation Distortion versus Output Power

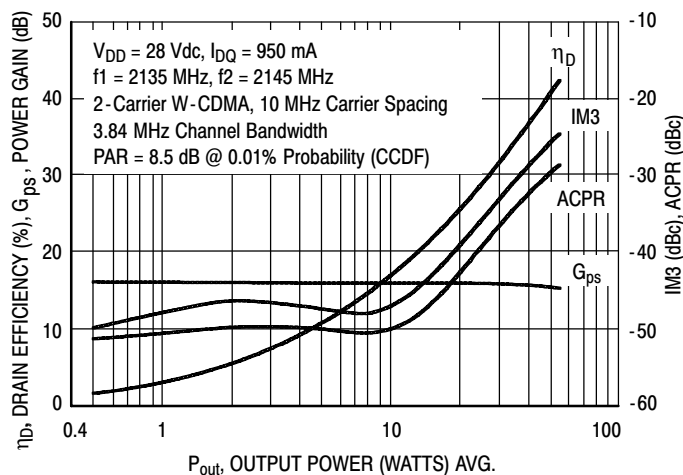
## TYPICAL CHARACTERISTICS



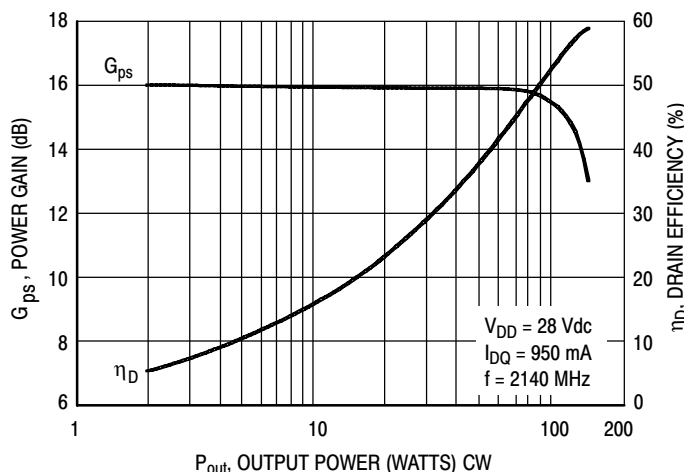
**Figure 7. Intermodulation Distortion Products versus Tone Spacing**



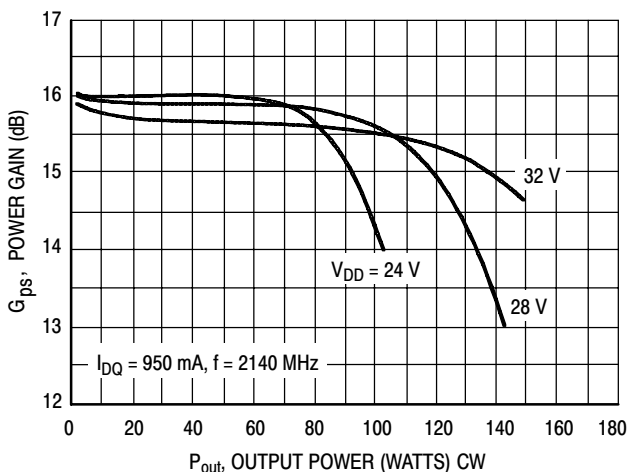
**Figure 8. Pulsed CW Output Power versus Input Power**



**Figure 9. 2-Carrier W-CDMA ACPR, IM3, Power Gain and Drain Efficiency versus Output Power**

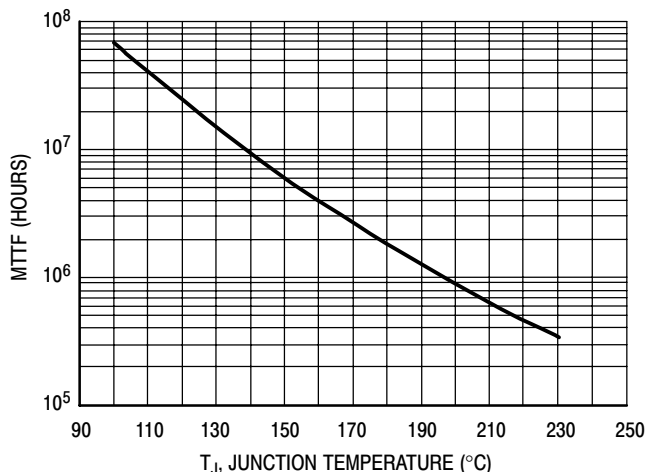


**Figure 10. Power Gain and Drain Efficiency versus CW Output Power**



**Figure 11. Power Gain versus Output Power**

## TYPICAL CHARACTERISTICS

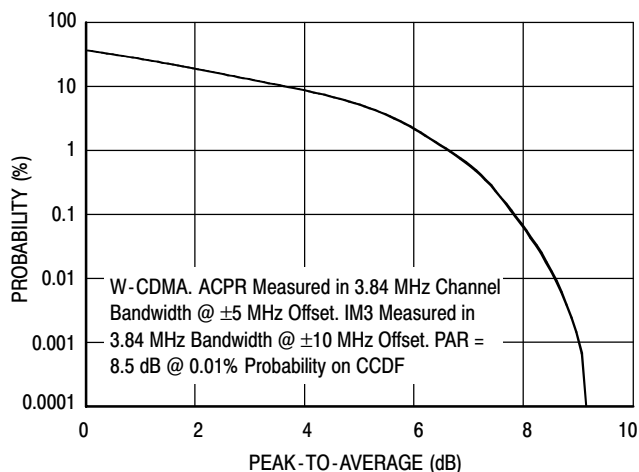


This above graph displays calculated MTTF in hours when the device is operated at  $V_{DD} = 28$  Vdc,  $P_{out} = 23$  W Avg., and  $\eta_D = 27.6\%$ .

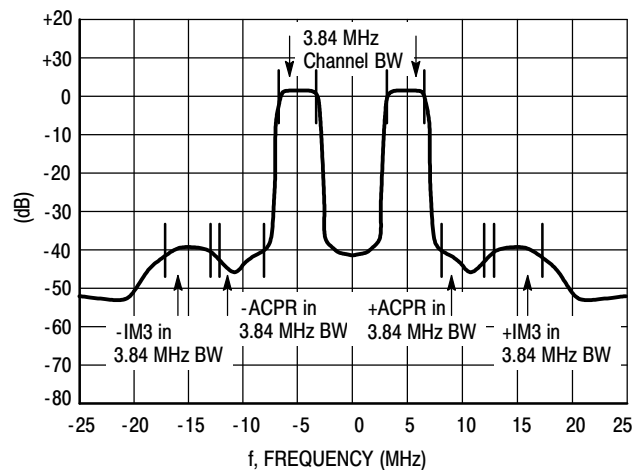
MTTF calculator available at <http://www.freescale.com/rf>. Select Tools/Software/Application Software/Calculators to access the MTTF calculators by product.

**Figure 12. MTTF versus Junction Temperature**

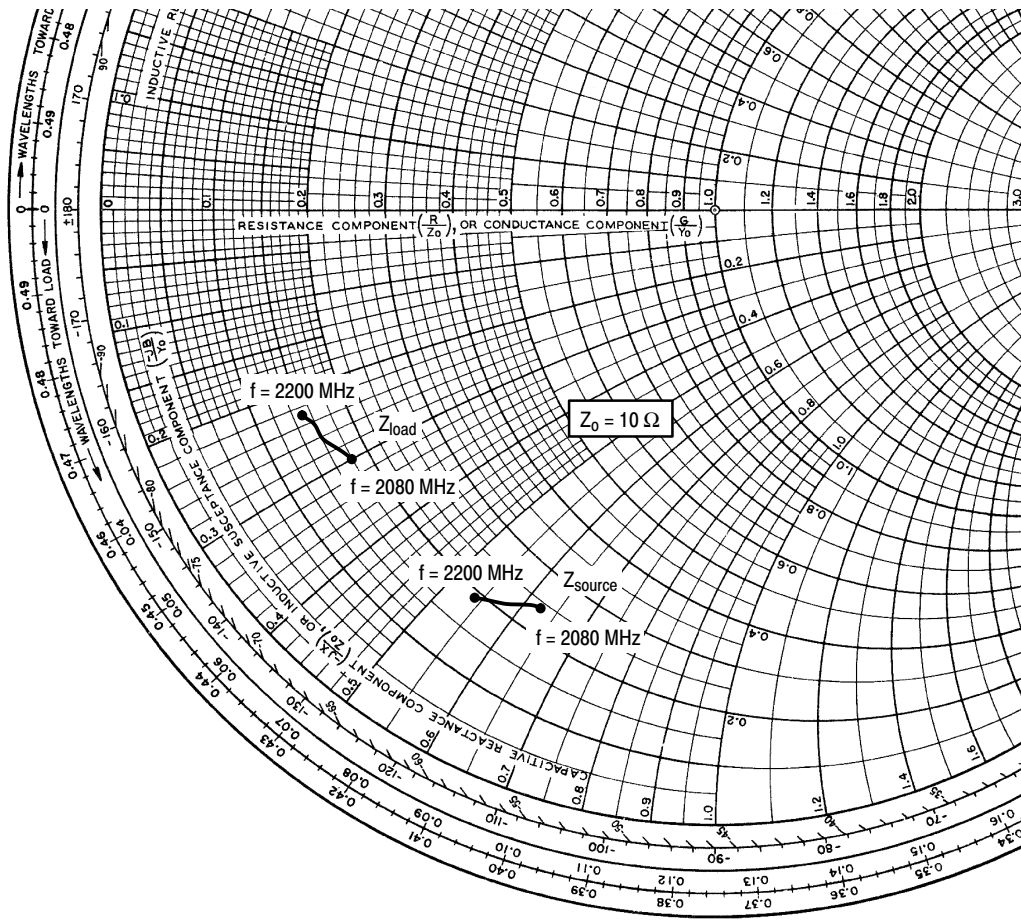
## W-CDMA TEST SIGNAL



**Figure 13. CCDF W-CDMA 3GPP, Test Model 1, 64 DPCH, 67% Clipping, Single-Carrier Test Signal**



**Figure 14. 2-Carrier W-CDMA Spectrum**



$V_{DD} = 28 \text{ Vdc}$ ,  $I_{DQ} = 950 \text{ mA}$ ,  $P_{out} = 23 \text{ W Avg.}$

f MHz	$Z_{source}$ $\Omega$	$Z_{load}$ $\Omega$
2080	$2.44 - j6.3$	$1.83 - j3.0$
2110	$2.25 - j6.1$	$1.74 - j2.8$
2140	$2.09 - j5.8$	$1.61 - j2.6$
2170	$1.98 - j5.6$	$1.59 - j2.5$
2200	$1.85 - j5.4$	$1.52 - j2.3$

$Z_{source}$  = Test circuit impedance as measured from gate to ground.

$Z_{load}$  = Test circuit impedance as measured from drain to ground.

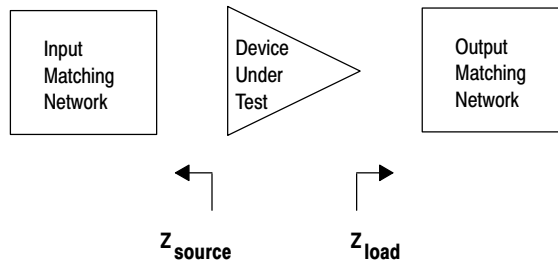
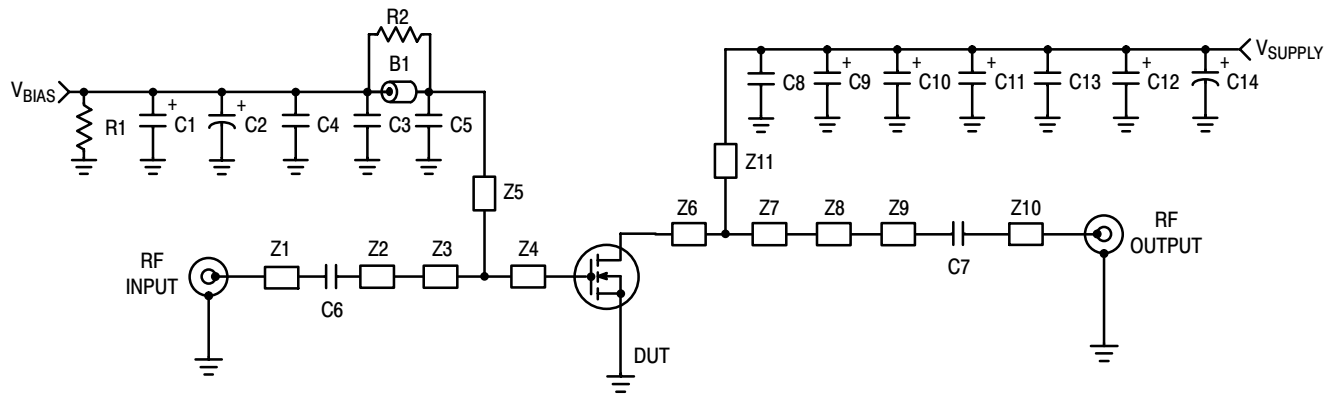


Figure 15. Series Equivalent Source and Load Impedance



## TD-SCDMA CHARACTERIZATION



Z1	1.250" x 0.084" Microstrip	Z7	0.320" x 0.880" Microstrip
Z2	0.930" x 0.084" Microstrip	Z8	0.370" x 0.200" Microstrip
Z3	0.470" x 0.800" Microstrip	Z9	0.650" x 0.084" Microstrip
Z4	0.090" x 0.800" Microstrip	Z10	1.230" x 0.084" Microstrip
Z5	1.500" x 0.040" Microstrip	Z11	0.870" x 0.120" Microstrip
Z6	0.160" x 0.880" Microstrip	PCB	Arlon GX-0300-55-22, 0.030", $\epsilon_r = 2.55$

**Figure 16. MRF6S21100HR3(SR3) Test Circuit Schematic — TD-SCDMA**

**Table 6. MRF6S21100HR3(SR3) Test Circuit Component Designations and Values — TD-SCDMA**

Part	Description	Part Number	Manufacturer
B1	Ferrite Bead	2743019447	Fair-Rite
C1	1.0 $\mu$ F, 50 V Tantalum Capacitor	T491C105M050AT	Kemet
C2	10 $\mu$ F, 50 V Electrolytic Capacitor	EEV-HB1H100P	Panasonic
C3	1000 pF 100B Chip Capacitor	ATC100B102JT500XT	ATC
C4, C13	0.1 $\mu$ F 100B Chip Capacitors	CDR33BX104AKWY	Kemet
C5	5.1 pF Chip Capacitor	ATC100B5R1JT500XT	ATC
C6, C7	15 pF Chip Capacitors	ATC100B150JT500XT	ATC
C8	6.8 pF Chip Capacitors	ATC100B6R8JT500XT	ATC
C9, C10, C11, C12	22 $\mu$ F, 35 V Tantalum Capacitors	T491X226K035AT	Kemet
C14	100 $\mu$ F, 50 V Electrolytic Capacitor	515D107M050BB6AE3	Vishay/Sprague
R1	1.0 k $\Omega$ , 1/8 W Chip Resistor	CRCW08051000FKTA	Vishay
R2	10 $\Omega$ , 1/8 W Chip Resistor	CRCW080510R0FKTA	Vishay

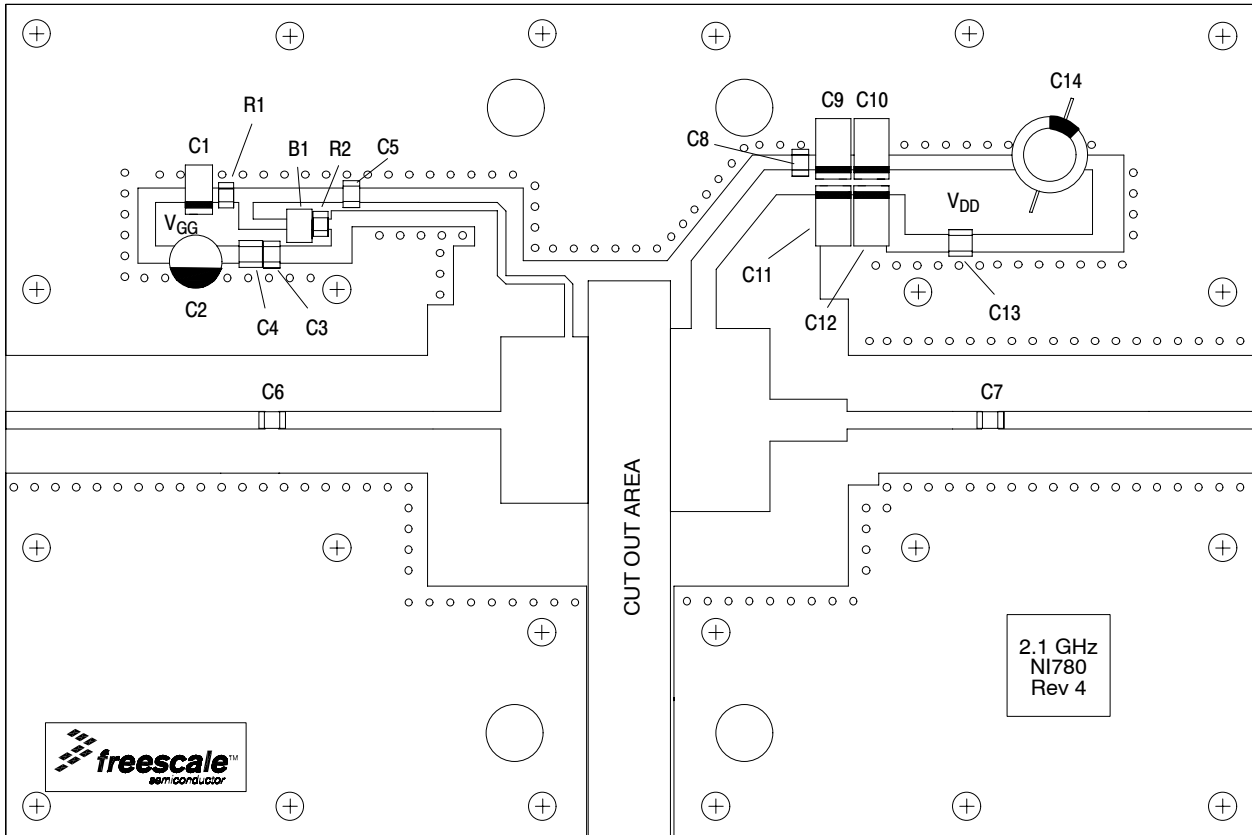
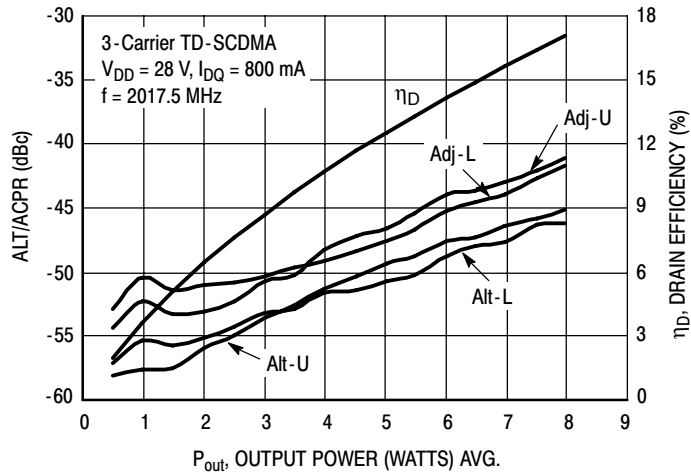
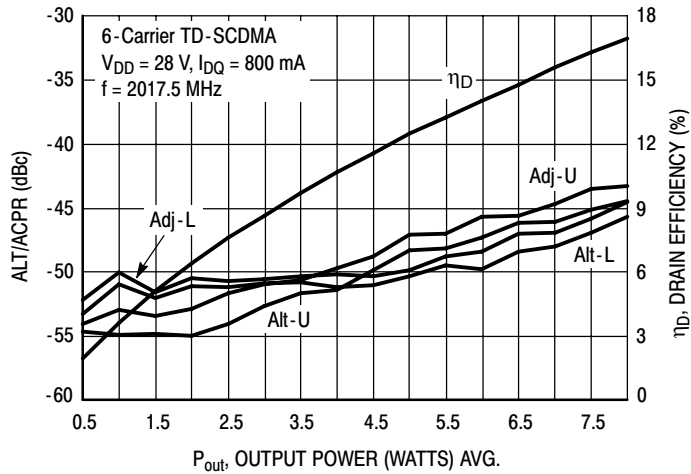


Figure 17. MRF6S21100HR3(SR3) Test Circuit Component Layout — TD-SCDMA

## TYPICAL CHARACTERISTICS

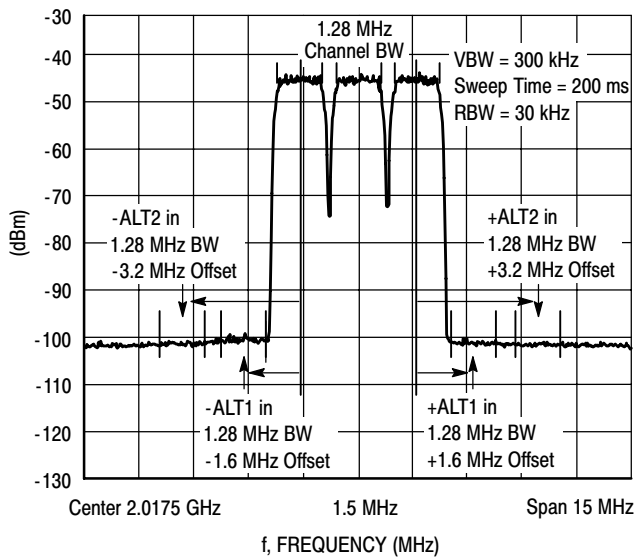


**Figure 18. 3-Carrier TD-SCDMA ACPR, ALT and Drain Efficiency versus Output Power**

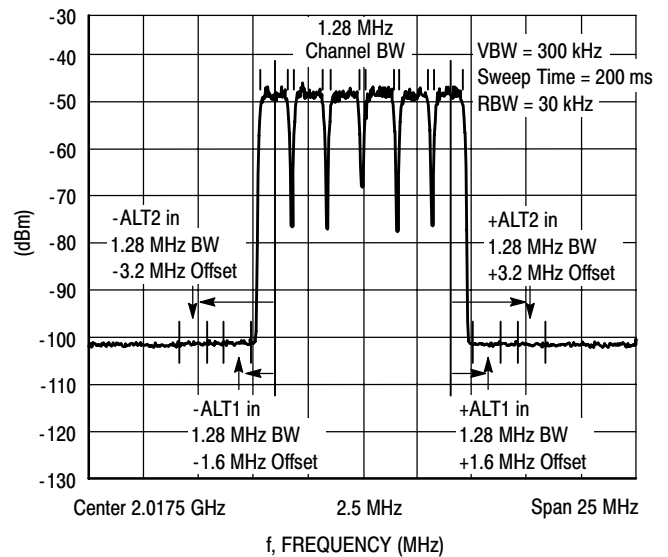


**Figure 19. 6-Carrier TD-SCDMA ACPR, ALT and Drain Efficiency versus Output Power**

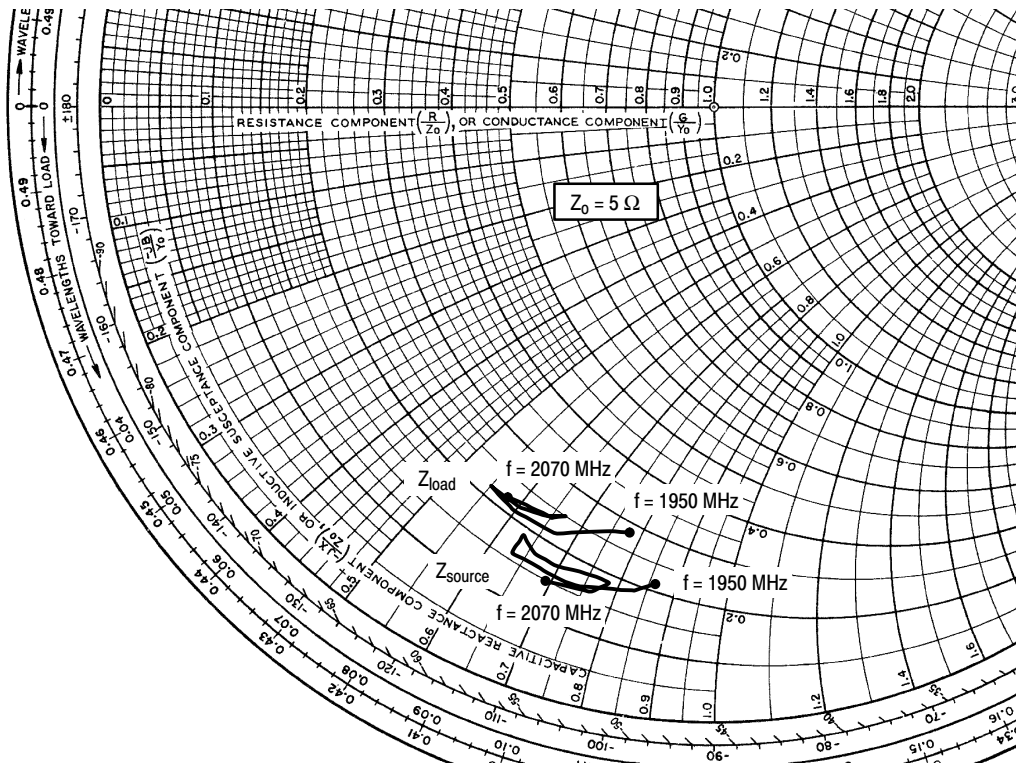
## TD-SCDMA TEST SIGNAL



**Figure 20. 3-Carrier TD-SCDMA Spectrum**



**Figure 21. 6-Carrier TD-SCDMA Spectrum**



$V_{DD} = 28 \text{ Vdc}$ ,  $I_{DQ} = 800 \text{ mA}$

f MHz	$Z_{\text{source}}$ $\Omega$	$Z_{\text{load}}$ $\Omega$
1950	1.04 - j4.28	1.38 - j3.90
1960	1.07 - j4.31	1.41 - j3.92
1970	0.96 - j4.13	1.29 - j3.71
1980	0.82 - j3.71	1.12 - j3.34
1990	0.79 - j3.34	1.07 - j2.96
2000	0.82 - j3.15	1.08 - j2.75
2010	0.88 - j3.16	1.12 - j2.76
2020	0.84 - j3.30	1.11 - j2.86
2030	0.83 - j3.47	1.12 - j3.01
2040	0.91 - j3.71	1.22 - j3.20
2050	0.91 - j3.90	1.25 - j3.34
2060	0.81 - j3.81	1.15 - j3.27
2070	0.76 - j3.45	1.09 - j2.92

$Z_{\text{source}}$  = Device input impedance as measured from gate to ground.

$Z_{\text{load}}$  = Test circuit impedance as measured from drain to ground.

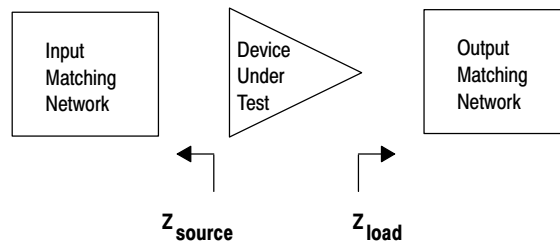
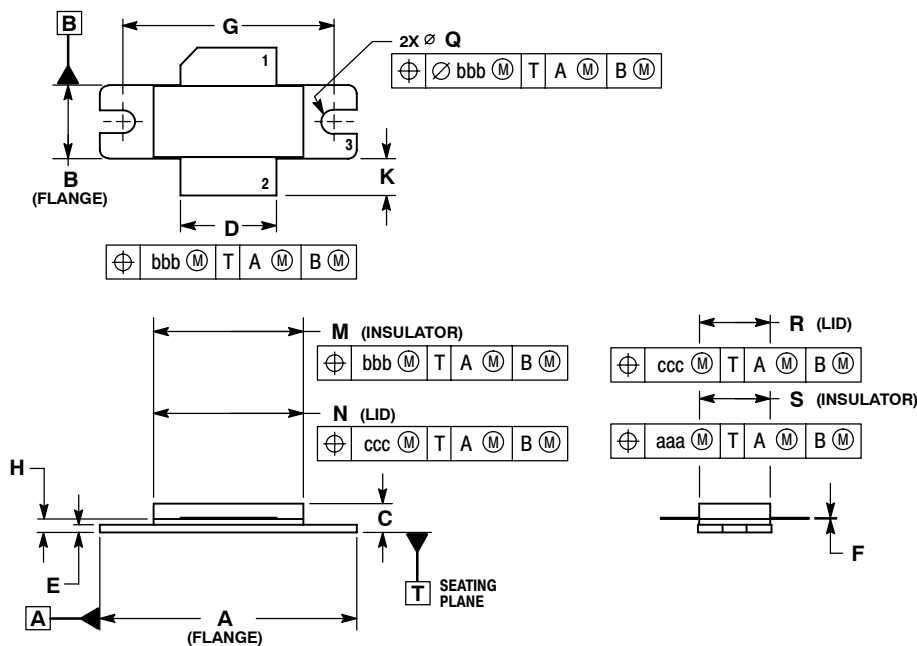


Figure 22. Series Equivalent Source and Load Impedance — TD-SCDMA

## PACKAGE DIMENSIONS

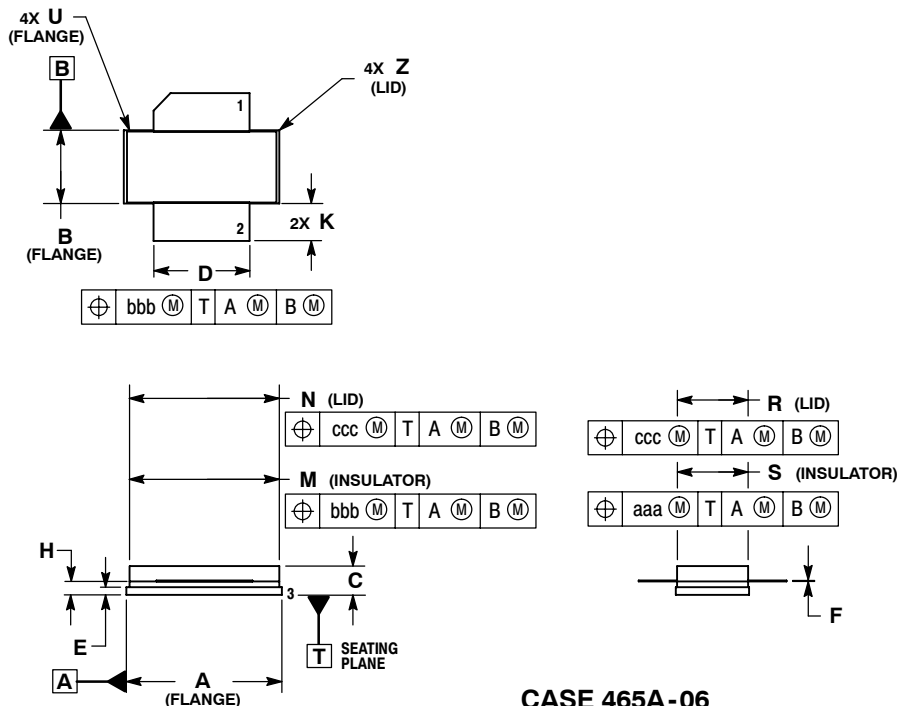


- NOTES:
1. DIMENSIONING AND TOLERANCING PER ANSI Y14.5M-1994.
  2. CONTROLLING DIMENSION: INCH.
  3. DELETED
  4. DIMENSION H IS MEASURED 0.030 (0.762) AWAY FROM PACKAGE BODY.

DIM	INCHES		MILLIMETERS	
	MIN	MAX	MIN	MAX
A	1.335	1.345	33.91	34.16
B	0.380	0.390	9.65	9.91
C	0.125	0.170	3.18	4.32
D	0.495	0.505	12.57	12.83
E	0.035	0.045	0.89	1.14
F	0.003	0.006	0.08	0.15
G	1.100	BSC	27.94	BSC
H	0.057	0.067	1.45	1.70
K	0.170	0.210	4.32	5.33
M	0.774	0.786	19.66	19.96
N	0.772	0.788	19.60	20.00
Q	∅.118	∅.138	∅3.00	∅3.51
R	0.365	0.375	9.27	9.53
S	0.365	0.375	9.27	9.52
aaa	0.005	REF	0.127	REF
bbb	0.010	REF	0.254	REF
ccc	0.015	REF	0.381	REF

- STYLE 1:  
 PIN 1. DRAIN  
 2. GATE  
 3. SOURCE

**CASE 465-06  
 ISSUE G  
 NI-780  
 MRF6S21100HR3**



- NOTES:
1. DIMENSIONING AND TOLERANCING PER ANSI Y14.5M-1994.
  2. CONTROLLING DIMENSION: INCH.
  3. DELETED
  4. DIMENSION H IS MEASURED 0.030 (0.762) AWAY FROM PACKAGE BODY.

DIM	INCHES		MILLIMETERS	
	MIN	MAX	MIN	MAX
A	0.805	0.815	20.45	20.70
B	0.380	0.390	9.65	9.91
C	0.125	0.170	3.18	4.32
D	0.495	0.505	12.57	12.83
E	0.035	0.045	0.89	1.14
F	0.003	0.006	0.08	0.15
H	0.057	0.067	1.45	1.70
K	0.170	0.210	4.32	5.33
M	0.774	0.786	19.61	20.02
N	0.772	0.788	19.61	20.02
R	0.365	0.375	9.27	9.53
S	0.365	0.375	9.27	9.52
U	---	0.040	---	1.02
Z	---	0.030	---	0.76
aaa	0.005	REF	0.127	REF
bbb	0.010	REF	0.254	REF
ccc	0.015	REF	0.381	REF

- STYLE 1:  
 PIN 1. DRAIN  
 2. GATE  
 5. SOURCE

**CASE 465A-06  
 ISSUE H  
 NI-780S  
 MRF6S21100HSR3**

MRF6S21100HR3 MRF6S21100HSR3

## PRODUCT DOCUMENTATION

Refer to the following documents to aid your design process.

### Application Notes

- AN1955: Thermal Measurement Methodology of RF Power Amplifiers

### Engineering Bulletins

- EB212: Using Data Sheet Impedances for RF LDMOS Devices

## REVISION HISTORY

The following table summarizes revisions to this document.

Revision	Date	Description
7	Jan. 2007	<ul style="list-style-type: none"><li>• Added "TD-SCDMA" to data sheet description paragraph, p. 1</li><li>• Removed Lower Thermal Resistance and Low Gold Plating bullets from Features section as functionality is standard, p. 1</li><li>• Removed Forward Transconductance from On Characteristics table as it no longer provided usable information, p. 2</li><li>• Updated Part Numbers in Table 5, Component Designations and Values, to RoHS compliant part numbers, p. 3</li><li>• Adjusted scale for Fig. 5, Two-Tone Power Gain versus Output Power, to better match the device's capabilities, p. 5</li><li>• Removed lower voltage tests from Fig. 11, Power Gain versus Output Power, due to fixed tuned fixture limitations, p. 6</li><li>• Replaced Fig. 12, MTTF versus Junction Temperature with updated graph. Removed Amps<sup>2</sup> and listed operating characteristics and location of MTTF calculator for device, p. 7</li><li>• Added TD-SCDMA test circuit schematic, component designations and values, component layout, typical characteristic curves, test signal and series impedance, p. 9-12</li><li>• Added Product Documentation and Revision History, p. 14</li></ul>

## **How to Reach Us:**

### **Home Page:**

[www.freescale.com](http://www.freescale.com)

### **Web Support:**

<http://www.freescale.com/support>

### **USA/Europe or Locations Not Listed:**

Freescale Semiconductor, Inc.  
Technical Information Center, EL516  
2100 East Elliot Road  
Tempe, Arizona 85284  
+1-800-521-6274 or +1-480-768-2130  
[www.freescale.com/support](http://www.freescale.com/support)

### **Europe, Middle East, and Africa:**

Freescale Halbleiter Deutschland GmbH  
Technical Information Center  
Schatzbogen 7  
81829 Muenchen, Germany  
+44 1296 380 456 (English)  
+46 8 52200080 (English)  
+49 89 92103 559 (German)  
+33 1 69 35 48 48 (French)  
[www.freescale.com/support](http://www.freescale.com/support)

### **Japan:**

Freescale Semiconductor Japan Ltd.  
Headquarters  
ARCO Tower 15F  
1-8-1, Shimo-Meguro, Meguro-ku,  
Tokyo 153-0064  
Japan  
0120 191014 or +81 3 5437 9125  
[support.japan@freescale.com](mailto:support.japan@freescale.com)

### **Asia/Pacific:**

Freescale Semiconductor Hong Kong Ltd.  
Technical Information Center  
2 Dai King Street  
Tai Po Industrial Estate  
Tai Po, N.T., Hong Kong  
+800 2666 8080  
[support.asia@freescale.com](mailto:support.asia@freescale.com)

### **For Literature Requests Only:**

Freescale Semiconductor Literature Distribution Center  
P.O. Box 5405  
Denver, Colorado 80217  
1-800-441-2447 or 303-675-2140  
Fax: 303-675-2150  
[LDCForFreescaleSemiconductor@hibbertgroup.com](mailto:LDCForFreescaleSemiconductor@hibbertgroup.com)

Information in this document is provided solely to enable system and software implementers to use Freescale Semiconductor products. There are no express or implied copyright licenses granted hereunder to design or fabricate any integrated circuits or integrated circuits based on the information in this document.

Freescale Semiconductor reserves the right to make changes without further notice to any products herein. Freescale Semiconductor makes no warranty, representation or guarantee regarding the suitability of its products for any particular purpose, nor does Freescale Semiconductor assume any liability arising out of the application or use of any product or circuit, and specifically disclaims any and all liability, including without limitation consequential or incidental damages. "Typical" parameters that may be provided in Freescale Semiconductor data sheets and/or specifications can and do vary in different applications and actual performance may vary over time. All operating parameters, including "Typicals", must be validated for each customer application by customer's technical experts. Freescale Semiconductor does not convey any license under its patent rights nor the rights of others. Freescale Semiconductor products are not designed, intended, or authorized for use as components in systems intended for surgical implant into the body, or other applications intended to support or sustain life, or for any other application in which the failure of the Freescale Semiconductor product could create a situation where personal injury or death may occur. Should Buyer purchase or use Freescale Semiconductor products for any such unintended or unauthorized application, Buyer shall indemnify and hold Freescale Semiconductor and its officers, employees, subsidiaries, affiliates, and distributors harmless against all claims, costs, damages, and expenses, and reasonable attorney fees arising out of, directly or indirectly, any claim of personal injury or death associated with such unintended or unauthorized use, even if such claim alleges that Freescale Semiconductor was negligent regarding the design or manufacture of the part.

Freescale™ and the Freescale logo are trademarks of Freescale Semiconductor, Inc. All other product or service names are the property of their respective owners.

© Freescale Semiconductor, Inc. 2007. All rights reserved.

